

ANBORINGSKLAMMER, Ø75MM
- Anboring: Ø50mm
- Rustfritt stål: AISI304/EN1.4301

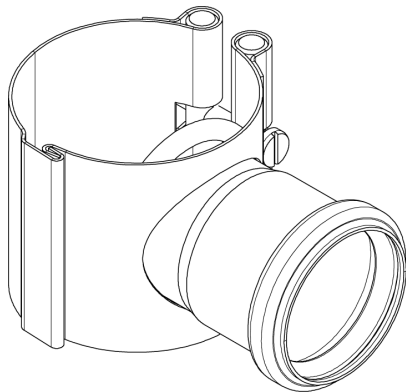

Type nr.: 890.075.050
EAN nr.: 5705499104837
VVS nr.: 154311312
RSK nr.: 1551578
NRF nr.: 3395078
LVI nr.:

Type: Klammer
Utløpsdia. (mm): 75
Vekt (kg): 1,24
Materiale: AISI 304
Materiale: EN 1.4301

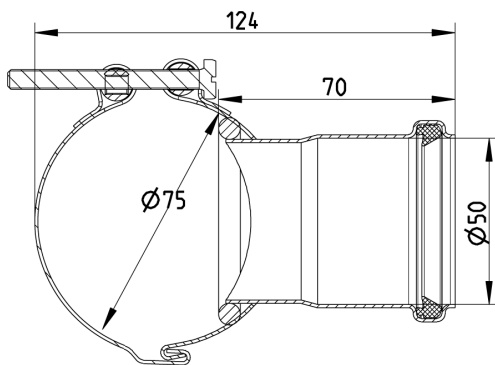

Godkjenninger
AUS - WMKT00204 - 18
DK - VA 2.21/19498