

Mess-, Regel- und Überwachungsgeräte für Haustechnik, Industrie und Umweltschutz

Lindenstraße 20
DE-74363 Güglingen
Telefon: +49(0)7135-102-0
Service: +49(0)7135-102-211
Telefax: +49(0)7135-102-147
E-Mail: info@afriso.de
Internet: www.afriso.de





Operating Instructions

Vacuum type leak detector Type: Eurovac 04-1 (LAZ-04/1)

Product No.: 43660



Technical Approval of the German Institute for Building Technology: Z-65.22-4

-  Read instructions before using device!
-  Observe all safety information!
-  Keep instructions for future use!



Contents

1	About this manual	4
1.1	Precautions	4
1.2	Explanation of notes, symbols and typeface	4
2	Safety	5
2.1	Intended use	5
2.2	Predictable incorrect application	6
2.3	Safe handling	6
2.4	Staff qualification	7
2.5	Modifications to the product	7
2.6	Usage of spare parts and accessories	7
2.7	Liability information	7
3	Product description	8
3.1	Design	8
3.2	System components, controls and display elements	9
3.3	Function	10
3.4	Operating modes	11
3.5	Application examples	11
4	Specifications	13
4.1	Approvals, tests and conformities	14
5	Transportation and storage	14
6	Mounting and commissioning	14
6.1	Installation site	14
6.2	Leak detector	15
6.3	Connection lines	15
6.4	Valve settings	18
6.5	Electrical connection	19
6.6	Commissioning device	20
7	Operation	21
7.1	Alarm	22
7.2	Test	22
8	Maintenance	23
8.1	Maintenance times	24
8.2	Maintenance activities	24
9	Troubleshooting	25
10	Shutting down and disposal	25
11	Spare parts and accessories	26

12	Warranty.....	26
13	Copyright.....	27
14	Customer satisfaction	27
15	Addresses	27
16	Appendix	27
16.1	Certificate of expert	27
16.2	List of substances for LAZ-04/1	28
16.3	Approval documents	31



1 About this manual

This instruction manual is part of the product.

- ▶ Read this manual before using the product.
- ▶ Keep this manual during the entire service life of the product and always have it readily available for reference.
- ▶ Always hand this manual over to future owners or users of the product.

1.1 Precautions

WARNING TERM Type and source of the danger is shown here.



- ▶ Precautions to take in order to avoid the danger are shown here.

There are three different levels of warnings:

Warning term	Meaning
DANGER	Immediately imminent danger! Failure to observe the information will result in death or serious injuries.
WARNING	Possibly imminent danger! Failure to observe the information may result in death or serious injuries.
CAUTION	Dangerous situation! Failure to observe the information may result in minor or serious injuries as well as damage to property.

1.2 Explanation of notes, symbols and typeface

Symbol	Meaning
<input checked="" type="checkbox"/>	Prerequisite for an activity
▶	Activity consisting of a single step
1.	Activity consisting of several steps
	Result of an activity
•	Bulleted list
Text	Indication on a display
Highlighting	Highlighting



2 Safety

2.1 Intended use

The LAZ-04/1 leak detector for vacuum systems is a class 1 leak detector according to EN 13160-1.

The LAZ-04/1 leak detector for vacuum systems may only be used to detect leaks in the containers (tanks) listed below which are not pressurised (i.e. operated under atmospheric conditions) and which are used for aboveground or underground storage of the liquids described below:

- Single-walled tanks according to DIN 6608, 6616, 6619, 6624 and 6625, or according to an approved design with leak protection lining which itself has an approved design.
- Double-walled tanks according to DIN 6608-2; 6616 design A; 6618-2; 6619-2; 6623-2; 6624-2 without leak detection fluid in the interstitial space (except a small volume in tanks according to DIN 6608).
- Double-walled tanks with design approval up to a height of 2.9 m or with a suction pipe leading to the bottom of the interstitial space.
- Double-walled tanks according to DIN 6608-2 with a layer of earth of at least 30 cm on top whose interstitial space is partially filled with leak detection fluid.
- Double-walled tanks for non-inflammable, water-polluting liquids as specified in the list of media in chapter 16.2, page 28.
- Double-walled tanks and tanks with an internal lining whose suitability for the use of leak detectors is demonstrated by a Technical Approval of the German Institute for Building Technology issued by TÜV Nord.

The LAZ-04/1 leak detector may only be used for the tanks listed above and with the following liquids:

- Inflammable liquids (mineral oil products) of danger class AIII.
- Non-inflammable, water-polluting liquids as specified in the list of media in chapter 16.2, page 28 and whose densities do not exceed the following densities, depending on the tank diameter and the tank height: Refer to table 1, page 6.

Please refer to the respective test certificates for the conditions for using the leak detectors with non-standard tanks with a mark of conformity.

Important: The interstitial space of the tank must be sufficiently resistant to the stored liquid.



Table 1: Tank Ø or tank height and density

Tank according to	Tank Ø or tank height	Permissible density of stored medium
DIN 6608	≤ 2.9 m	≤ 1040 kg/m ³
DIN 6616	≤ 2.5 m	≤ 1200 kg/m ³
DIN 6624	≤ 2.0 m	≤ 1500 kg/m ³
	≤ 1.6 m	≤ 1880 kg/m ³
	≤ 1.25 m	≤ 1900 kg/m ³
DIN 6618 Teil 2	≤ 15.95 m	≤ 1120 kg/m ³
	≤ 12.75 m	≤ 1470 kg/m ³
	≤ 9.585 m	≤ 1900 kg/m ³
DIN 6619	≤ 2.84 m	≤ 1060 kg/m ³
	≤ 2.76 m	≤ 1090 kg/m ³
	≤ 2.6 m	≤ 1160 kg/m ³
	≤ 1.9 m	≤ 1580 kg/m ³
DIN 6623	≤ 1.2 m	≤ 1900 kg/m ³

The LAZ-04/1 leak detector creates a vacuum (approx. –400 mbar) in the interstitial chamber and generates an alarm when the pressure falls below the minimum level (approx. –340 mbar).

Any use other than the use explicitly permitted in this instruction manual is not permitted.

2.2 Predictable incorrect application

The LAZ-04/1 leak detector must never be used in the following cases:

- Hazardous area (potentially explosive atmosphere)
- Use with any liquid other than the liquids mentioned above
- Use with aggressive liquids which attack the connection hoses and the leak detector.

2.3 Safe handling

The LAZ-04/1 leak detector represents state-of-the-art technology and is made according to the pertinent safety regulations. Each device is subjected to a function and safety test prior to shipping.

- ▶ Operate the LAZ-04/1 leak detector only when it is in perfect condition. Always observe the operating instructions, all pertinent local and national directives and guidelines as well as the



applicable safety regulations and directives concerning the prevention of accidents.

WARNING **Severe burns or death due to mains voltage in the control unit.**



- ▶ Do not expose the control unit to water.
 - ▶ Interrupt the mains voltage supply before opening the control unit or before performing maintenance and cleaning work and make sure it cannot be switched on by accident.
 - ▶ Do not tamper with the control unit in any way whatsoever.
-

2.4 Staff qualification

The product may only be mounted, commissioned, operated, maintained, shut down and disposed of by qualified, specially trained staff.

Electrical work may only be performed by trained electricians qualified in accordance with the local and national directives such as VDE.

2.5 Modifications to the product

Changes or modifications made to the product by unauthorised persons may lead to malfunctions and are prohibited for safety reasons.

2.6 Usage of spare parts and accessories

Usage of unsuitable spare parts and accessories may cause damage to the product.

- ▶ Use only genuine spare parts and accessories of the manufacturer (refer to chapter 11, page 26).

2.7 Liability information

The manufacturer shall not be liable for direct or consequential damage resulting from failure to observe the technical instructions, guidelines and recommendations. The manufacturer and the sales company shall not be liable for costs or damages incurred by the user or by third parties in the usage or application of this device, in particular in case of improper use of the device, misuse or malfunction of the connection, malfunction of the device or of connected devices. The manufacturer or the sales company shall not be liable for damages resulting from any use other than the use explicitly permitted in this instruction manual.

The manufacturer shall not be liable for misprints.



3 Product description

3.1 Design

The LAZ-04/1 leak detector contains the following elements in an impact-resistant plastic housing: display elements and controls, a vacuum pump, a pressure switch, a printed circuit board with the electronic components for processing the output signal, a filter and three hose connections for the pneumatic connection to the interstitial space of the tank. The green pilot lamp lights up when mains voltage (230 V~) is available. The leak detector generates a constant vacuum in the interstitial space of the tank and generates alarm in case of a pressure drop. The alarm is indicated visually and audibly and is made available via a voltage-free relay contact (1 changeover contact).



3.2 System components, controls and display elements

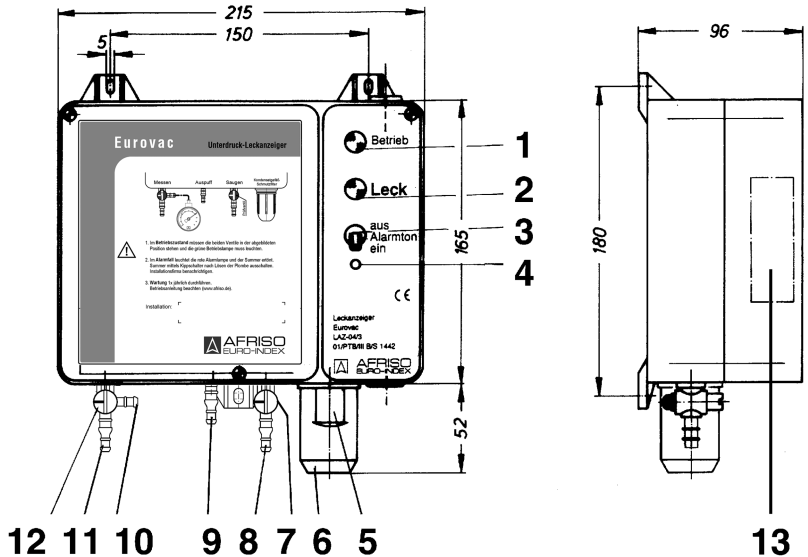

Fig. 1: Exterior view

- | | |
|-----------------------|------------------------------|
| 1 Green pilot lamp | 8 Suction line connection |
| 2 Red alarm lamp | 9 Exhaust connection |
| 3 Toggle switch | 10 Pressure gauge connection |
| 4 Lead seal fastening | 11 Capillary tube connection |
| 5 Filter | 12 Measurement valve |
| 6 Condensate trap | 13 Type designation plate |
| 7 Test valve | |

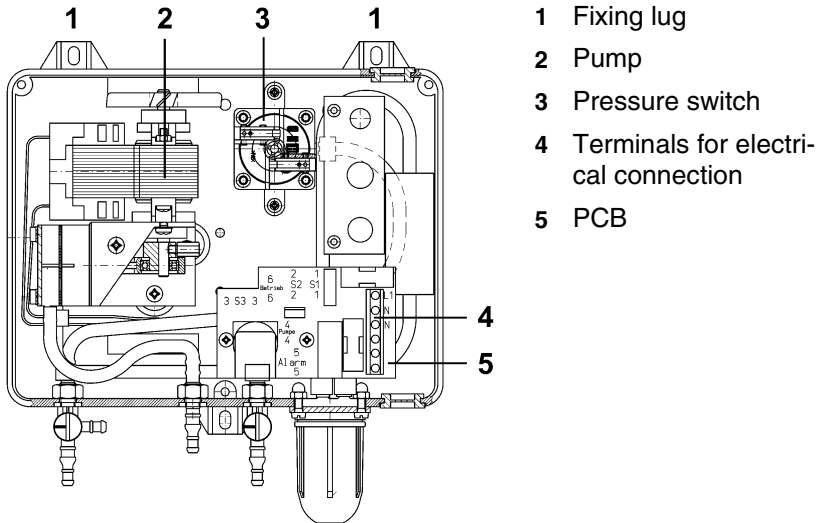

Fig. 2: Interior view

3.3 Function

The green pilot lamp lights up when mains voltage is available and the device is ready for operation.

Via the suction line, the vacuum pump installed in the leak detector generates a vacuum within the range of approx. -400 mbar in the interstitial space of the tank.

The pressure switch measures the pressure in the interstitial space via the capillary tube and keeps it at a constant level together with the vacuum pump.

If a leak occurs in the tank's wall or in the leak protection lining (in the inner or outer wall of the tank) either above or below the level of the stored liquid or the ground water, and if this leak is greater than the pump's suction capacity, the vacuum will drop. If the pressure falls below the minimum pressure -340 mbar, the leak detector will trigger an alarm, i.e. the red alarm lamp and the audible alarm will be activated and the output relay will be energised.

The audible alarm can be deactivated using the "Alarm tone" toggle switch after you have broken the seal.

No alarm is triggered in case of a power failure. When mains power is available again, the device immediately resumes operation. If a leak has occurred in the meantime, this is indicated.

3.4 Operating modes

The LAZ-04/1 leak detector is equipped with an output relay to transmit the alarm signal to additional external devices. If no error condition is present, the relay is de-energised. In case of an alarm, the relay is energised.

The LAZ-04/1 leak detector can be operated with or without additional external devices. The following types of additional devices can be used:

- Visual and audible alarm units,
- telecommunication devices,
- building control systems,
- building automation systems, etc.

3.5 Application examples

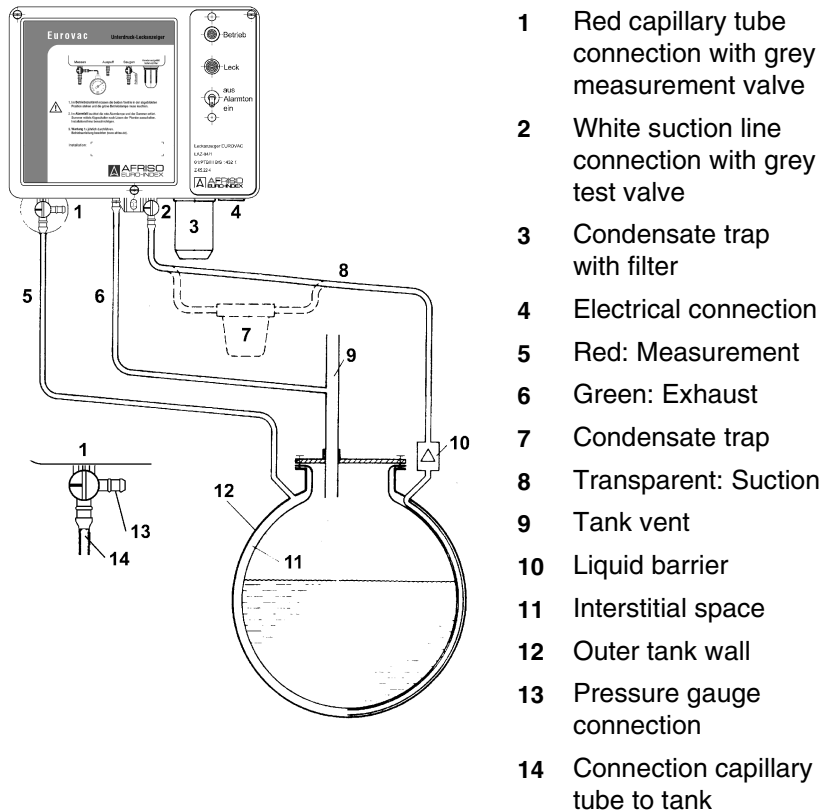

Fig. 3: Application example

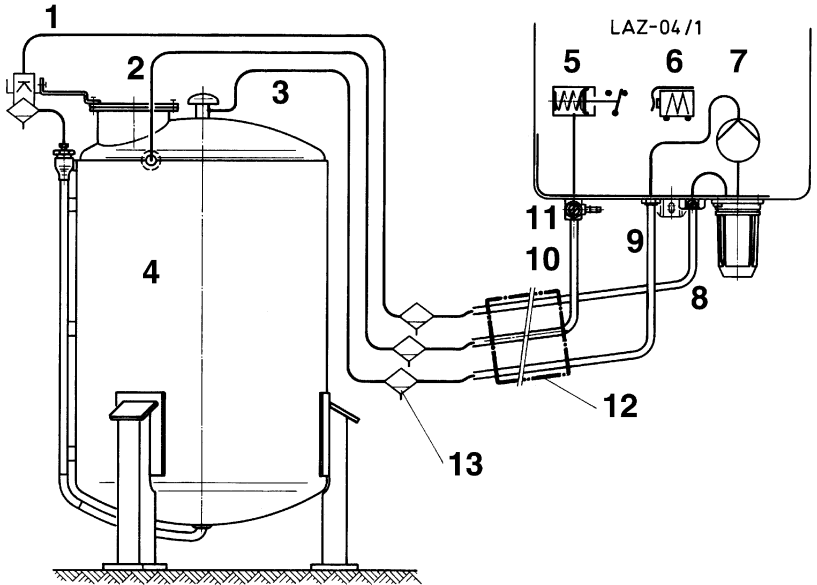

Fig. 4: LAZ-04/1 at vertical tank according to DIN 6618-2

- | | |
|----------------------------------|------------------------------------------------------|
| 1 Liquid barrier in suction line | 8 White: Suction |
| 2 Capillary tube | 9 Green: Exhaust |
| 3 Exhaust | 10 Red: Measurement |
| 4 DIN 6618-2 | 11 Measurement valve |
| 5 Vacuum switch | 12 Protective pipe for underground installation |
| 6 Alarm buzzer | 13 Condensate trap installed at lowest point of line |
| 7 Vacuum buzzer | |

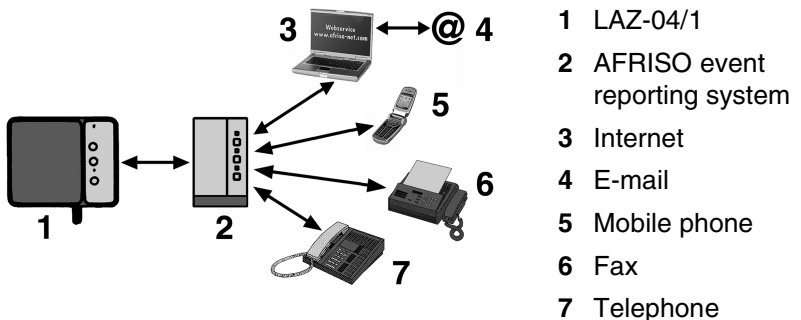

Fig. 5: Remote leak reporting with AFRISO event reporting system



4 Specifications

Table 2: Specifications

Parameter	Value
General	
Dimensions (W x H x D)	215 x 235 x 100 mm
Space requirements (W x H x D)	250 x 400 x 800 mm
Weight	1.7 kg
Emissions	Min. 70 dB(A), A-evaluated sound level of the audible alarm at a distance of one metre
Output relay	1 changeover contact
Breaking capacity output relay	Max. 250 V, 2 A, resistive load
Relay contact fuse	T 2 A
Switch point Alarm On	-325 to -355 mbar
Switch point Alarm Off	-380 mbar (point of reference, results from switching hysteresis)
Switch point Pump On	-380 mbar (point of reference, results from switching hysteresis)
Switch point Pump Off	-410 to -450 mbar
Hose connection	Ø 5 mm
Connecting hose	PVC hose 4 x 2 mm, 6 x 2 mm
Operating temperature range	
Ambient	-5 °C to +50 °C
Storage	-10 °C to +60 °C
Supply	
Supply voltage	230 V~
Rated power	95 VA
Mains fuse	T 0.8 A
Electrical safety	
Protection class	II EN 60730



Parameter	Value
Protection	IP 30 EN 60529
Electromagnetic compatibility (EMC)	
Noise suppression	According to EN 50081-1
Noise immunity	According to EN 50082-2

4.1 Approvals, tests and conformities

The LAZ-04/1 leak detector has the Qualification Approval 01/PTB No. III B/S 1432 and the Technical Approval of the German Institute for Building Technology PA-VI 62.1.07 and conforms to the EMC directive (89/336/EEC and 92/31/EEC) and the Low Voltage Directive (73/23/EEC and 93/68/EEC).

5 Transportation and storage

CAUTION **Damage to the device due to improper transportation.**



- ▶ Do not throw or drop the device.
- ▶ Protect the device from wetness, humidity, dirt and dust.

CAUTION **Damage to the device due to improper storage.**



- ▶ Protect the device from wetness, humidity, dirt and dust.

6 Mounting and commissioning

The leak detector may only be installed and commissioned by a specialised company in accordance with § 19 I WHG.

6.1 Installation site

- The leak detector must be mounted to an even, rigid and dry wall at eye level.
- The leak detector must be accessible and easy to oversee at all times.
- Choose an installation site that is as close as possible to the tank to be monitored. The ambient temperature must be in range.



- In the case of outdoor installation, the leak detector must be protected from direct atmospheric influences (use an IP 55 protective housing).
- The leak detector must be mounted in such a way that it cannot be reached by water or splash water.
- Installation in damp rooms is not permitted.
- The leak detector must not be installed in hazardous areas or in access chambers of underground tanks.

6.2 Leak detector

1. Loosen the three housing screws at the front side of the leak detector and remove the upper part of the housing.
2. Mount the housing base to the wall by means of the enclosed dowels and screws (3 pieces DIN 96-4 x 30).
3. Connect the unit electrically as described in chapter 6.4, page 18.
4. Refit the upper part of the housing and fasten it with the three housing screws.

6.3 Connection lines

1. Connect the leak detector and the tank top to be monitored as shown in fig. 3, page 11, and fig. 4, page 12.

You may use coloured plastic hoses 4 x 2 mm for lengths of up to 10 m. If the length exceeds 10 m, use steel pipes, copper pipes or plastic hoses with an inside diameter of 6 mm. The connection pipes or hoses must be pressure-proof, oil-, water- and weather-resistant. The connection lines must be permanently colour-coded:

- Capillary tube made of hose: Red
 - Capillary tube made of pipe: Red rings at the ends of the pipe
 - Suction hose: White or transparent
 - Suction pipe: White rings at the ends of the pipe
 - Exhaust hose: Green
 - Exhaust pipe: Green rings at the ends of the pipe
2. The connection lines must have a steady gradient from the leak detector to the tank. Do not fit any shut-off elements.
 3. If a steady gradient to the tank cannot be maintained, install condensate traps at the lowest points.
 4. In case of underground connection or outdoor installation of plastic hoses, use weather-resistant protective pipes.
 5. Connect the capillary tube to the capillary connection of the tank.



6. Connect the exhaust pipe or hose to the tank vent pipe.
7. Connect the suction line to the hose connection of the interstitial space of the tank.
8. A liquid barrier must be installed in the suction hose. The liquid barrier must be mounted vertically, e.g. at the manhole cover.

In the case of aboveground, outdoor tanks, the connection lines must have an inside diameter of at least 6 mm (and a wall thickness of 2 mm if plastic pipes are used) and a slope of at least 4 %.

9. If you use hoses for the suction, capillary and exhaust lines, secure all transition and connection points of the hoses with hose clamps that cover the entire circumference.
10. The connection lines must have the full cross section over the entire length, there must be no bends and indentations.

Do not fit any shut-off elements.

Tanks according to DIN 6608-2 with earth coverage whose interstitial space is still (partially) filled with leak detection fluid

1. Have a collecting container (bucket with at least 10 l capacity) ready.
2. Disconnect the connection hose/tube of the leak detection fluid container from the tank.
3. Collect the escaping leak detection fluid in the bucket.
4. Dismount the test cock, the connection line and the container for the leak detection fluid with the plug-in probe.
5. Clean the 1" threaded sockets for the leak detection fluid container and the test cock and mount/seal suitable adapters and hose connection pieces so that the suction hose and capillary tube of the LAZ-04/1 leak detector can be connected.
6. Provide a suction pump (min. capacity 1.5 m³/hour) to remove the liquid from the interstitial space of the tank. In addition, you need a carboy with a capacity of at least 10 l.
7. Insert two hoses into the carboy neck and seal them (suction hose pump, suction hose tank). Leave the hose connection for the capillary tube open for the the time being so that air can be admitted.
8. Suck the leak detection fluid from the interstitial space into the carboy until the liquid column becomes unstable and air is withdrawn.

Remove the maximum possible volume of liquid from the interstitial space. A specified minimum volume must be withdrawn in any event:

*Table 3: Minimum volume to be withdrawn*

Tank capacity	Minimum volume to be withdrawn
1-5 m ³	5 l
7-13 m ³	10 l
16-30 m ³	15 l
40-60 m ³	30 l
80-100 m ³	35 l

9. Connect vacuum gauges to the capillary tube connection.
10. Then keep withdrawing at a vacuum of -0.5 to -0.8 bar.
11. It is absolutely indispensable for the top area of the tank to contain air. When the pumped volume decreases, interrupt the pumping process several times so that additional liquid can flow. If the suction volume becomes too small, alternating withdrawal via the capillary tube connection may prove to be more successful.
12. Always make sure to withdraw the maximum volume possible, but at least the volume specified in table 3, page 17 so that a sufficient air volume is created above the remaining liquid.
13. Dismount the pumping equipment.
14. Connect the suction hose, capillary tube and exhaust hose according to the instructions in chapter 6.3, page 15, and commission the leak detector.

Storage of non-inflammable, water-polluting liquids in double-walled tanks

- ▶ Refer to table 1, page 6, to make sure that the density of the stored liquid does not exceed the specified limit value depending on the tank type and tank diameter or tank height.

Connecting lines, liquid barrier, connection pieces and condensate traps must be resistant to the stored liquid and its vapours.



6.4 Valve settings

Measurement valve at red capillary tube connection

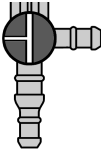





Table 4: Settings of measurement valve

Valve setting	Operating status
	Normal operation
	Test with pressure gauge
	Not permitted
	Not permitted

Test valve at white suction line connection

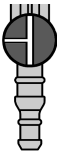





Table 5: Settings of test valve

Valve setting	Operating status
	Normal operation
	Venting
	Not permitted
	Not permitted



6.5 Electrical connection

- ☑ Device is disconnected from mains and cannot be switched on.
- Observe the VDE regulations, the pertinent regulations concerning the prevention of accidents, the operating instructions for the leak detector and the tank as well as all other applicable national and local regulations.
- Connect the leak detector directly to the 230 V supply network without a switch and without a plug.

Power supply

Connect the leak detector to mains by means of a permanently installed cable such as NYM-J 3 x 1.5 mm².

1. Route the power supply cable through the rubber cable gland at the bottom right into the leak detector.
2. The phase must be connected to terminal L1, the neutral conductor to terminal N. The leak detector supply cable should have a separate fuse (max. 16 A).

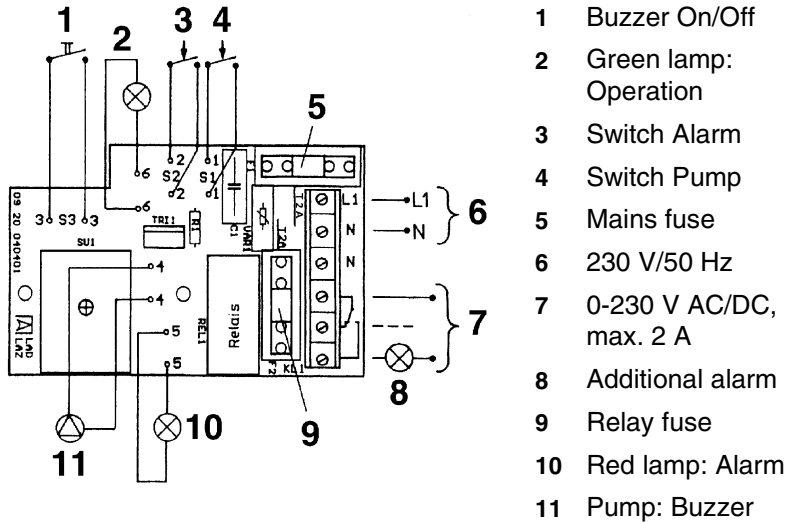

Fig. 6: Electrical connection

Output

The output signal of the LAZ-04/1 leak detector is made available via a voltage-free relay contact (1 changeover contact).

- The relay cable must also be permanently installed. Route it through the rubber cable gland at the top right into the leak detector. Connect it to the designated terminals ('relay contact').

If no error condition is present, the relay is de-energised. In case of an alarm, the relay is energised. The relay contact is fused with a 2 A fuse (slow-blow).

CAUTION

Voltage peaks occur when inductive consumers are switched off. These peaks may considerably interfere with the function of electrical installations and destroy the switching contact.

- ▶ Use commercially available standard RC combinations such as 0.1 μ F/100 Ohm for inductive consumers.

6.6 Commissioning device

Basic vacuum

The suction pump of the leak detector must not exceed a given capacity (100 l/h). Therefore, the interstitial space should be evacuated to a vacuum of approximately -400 mbar before the leak detector is connected. Use an installation pump with a greater volume capacity for this purpose.

Leak test

Check for leaks in the interstitial space. A slight pressure drop in the first hour is unavoidable. After that, there should be no noticeable pressure loss.

Adaptation

Before the leak detector can be connected, the vacuum in the interstitial space must be reduced to -370 mbar. If the vacuum is greater when LAZ-04/1 is connected, the measuring system may be damaged or destroyed.

Commissioning

- Leak detector is mounted and installed as per chapter 6.2, page 15.
- Electrical connection as per chapter 6.4, page 18.
- Both valves are in "Normal Operation" setting.



*Measurement valve
(red connection)*



*Test valve
(white connection)*

- Interstitial space is pre-evacuated.



- ☑ Interstitial space is checked for leaks.
- ☑ Vacuum in interstitial space is reduced to -370 mbar.
- ☑ Leak detector is connected to interstitial space.
- ☑ Liquid barrier is installed.
- ☑ Leak detector housing is closed with screws.
- ▶ Switch on the power supply via the on-site mains fuse.
- ↪ The green pilot lamp lights up.
- ↪ The pump controller ensures the operating vacuum is available. If the operating vacuum drops below the "Alarm ON" switch point, the red alarm lamp lights up, the audible alarm is triggered and the relay is energised.
- ▶ The audible alarm can be muted via the toggle switch. Once the set vacuum is reached, the pump of the leak detector switches off.
- ▶ Now the toggle switch must be set to the "ON" position and lead-sealed.
- ↪ The system is now ready for operation.
- ▶ Have the specialised company certify the installation, commissioning and test of the leak detector using the form in chapter 16.1, page 27.

7 Operation

The leak detector monitors double-walled tanks. If a leak occurs, the vacuum in the interstitial space drops and the leak detector generates an alarm.

The operation of the leak detector is therefore limited to its regular monitoring:

- The green pilot lamp is on.
- The red alarm lamp is off.
- The audible alarm is off.

When the leak detector is tested (refer to chapter 7.2, page 22), the red alarm lamp must light up and the audible alarm must switch on.



7.1 Alarm

1. In the case of an alarm, the audible alarm can be muted via the toggle switch after you have broken the seal.
 - ↪ The red alarm lamp remains on.
2. Immediately notify the installation company.
 - ↪ The installation company must find the reason for the alarm.
3. When the problem has been fixed, you must perform a full function test as per chapter 7.2, page 22.

7.2 Test

- ▶ The function of the leak detector must be checked:
 - After each commissioning
 - At least once per year by an expert
 - After each alarm and fault repair

Test by simulation

To guarantee operational reliability, perform a function check at least once per year by simulating a real alarm condition.

A vent valve is connected to the white suction line connection.

1. Set the test valve (white connection) to "Vent".



- ↪ The interstitial space of the tank is vented.
 - ↪ The vacuum in the interstitial space drops and the leak detector triggers an alarm.
2. Set the test valve (white connection) to "Normal Operation".



- ↪ The vacuum in the interstitial space is regenerated.
- ↪ The alarm signals must switch off automatically.

Test by measurement

The lateral connection of the red capillary tube connection is provided for connecting a vacuum gauge to test the system.

1. Connect the vacuum gauge (0-1000 mbar).
2. Set the measurement valve (red connection) to "Test".



- ↪ The gauge indicates the vacuum in the interstitial space.



3. Set the test valve (white connection) to "Vent".



4. The vacuum drops slowly.

4. Observe the gauge and record the pressure values at which the pump and the alarm signals are switched on.

1. Set the test valve (white connection) to "Normal Operation".



2. Compare the recorded values to the set values.

3. Set the measurement valve (red connection) to "Normal Operation".



4. Disconnect the vacuum gauge.

5. You must create a test report and keep it along with the other documents for the leak detector.

The pressure switch integrated in the leak detector may only be adjusted and calibrated by the manufacturer or by trained staff.

8 Maintenance

Maintenance must be performed by a specialised company unless the applicable local and/or national legislation and regulations explicitly exempt you from this obligation.

- ▶ If required, close a maintenance agreement with a specialised company (according to the German Water Protection Act § 19 I WHG or the regulations applicable in your country).

A leak detector is safety equipment that may only be repaired by the manufacturer in case of damage.



8.1 Maintenance times

Table 6: Maintenance times

When	Activity
Once per year	<ul style="list-style-type: none"> <li data-bbox="423 260 1070 320">▶ Simulation of an alarm condition, refer to chapter 7.2, page 22. <li data-bbox="423 331 1070 523">▶ The condensate trap at the leak detector and the condensate traps installed in the hoses (if applicable) must be checked and drained. Replace the filter in the non-return valve and tightly screw the condensate trap back into the housing. <li data-bbox="423 534 1070 627">▶ Perform suitable checks to ensure that the leak detector and its environment site are always clean, accessible and easy to oversee.

8.2 Maintenance activities

Replacing the mains fuse F1

1. Switch off the mains voltage.
2. Remove the upper part of the housing.
3. Remove the transparent cover from the mains fuse.
4. Replace the mains fuse F1: T 0.8 A.
5. Snap the transparent cover onto the mains fuse.
6. Refit the upper housing part and screw it to the base.
7. Switch on the mains voltage.

Replacing the relay fuse F2

1. Switch off the mains voltage.
2. Remove the upper part of the housing.
3. Remove the transparent cover from the mains fuse.
4. Replace the mains fuse F2: T 2 A.
5. Snap the transparent cover onto the mains fuse.
6. Refit the upper housing part and screw it to the base.
7. Switch on the mains voltage.

9 Troubleshooting

Repair work may only be performed by qualified, specially trained staff.

Table 7: Troubleshooting

Problem	Possible reason	Repair
Green pilot lamp is not on.	No mains voltage available.	<ul style="list-style-type: none"> ▶ Check mains voltage. ▶ Check mains fuse.
Red alarm lamp lights up.	Leak.	▶ Check hoses.
	Vent valves are closed.	▶ Close the filter chamber.
	-	▶ Notify the installation company.
Red alarm lamp lights up, but audible alarm is not activated.	Seal is missing.	▶ Set toggle switch to "On" position and seal it.
Water in condensate trap.	-	▶ Drain condensate trap.
Filter polluted.	-	▶ Replace filter.
Other malfunctions.	-	▶ Send the device to the manufacturer.

10 Shutting down and disposal

1. Switch off mains voltage.
2. Dismount the device (see chapter 6, page 14, reverse sequence of steps).
3. To protect the environment, this device must **not** be disposed of together with the normal household waste. Dispose of the device according to the local conditions and directives.



This device consists of materials that can be reused by recycling firms. The electronic inserts can be easily separated and the device consists of recyclable materials.

If you do not have the opportunity to dispose of the used device in accordance with environmental regulations, please contact us for possibilities to dispose of it or to return it.



11 Spare parts and accessories

Product	Product No.
LAZ-04/1 in protective housing with audible alarm	43665
Audible alarm, weatherproof	61012
Alarm lamp, weatherproof	61015
Condensate trap bar, triple	43692
PVC hose 4 x 2 mm, 100 m, red	43648
PVC hose 4 x 2 mm, 100 m, green	43649
PVC hose 4 x 2 mm, 100 m, transparent	43650
PVC hose 6 x 2 mm, 100 m, red	43662
PVC hose 6 x 2 mm, 100 m, green	43663
PVC hose 6 x 2 mm, 100 m, transparent	43664
Hose connector for 4 x 2 mm	20036
Pump for LAZ-04/1	43651
Pressure switch for LAZ-04/1	43653
Non-return valve	43605
Pilot lamp green	43661
Alarm lamp red	43658
Event reporting system AM1	90001
Event reporting system GSM Alarm	90002
Hose clamp 8 mm	810 000 0004
RC combination 0.1 μ F/100 W	618 001 5100
Mains fuse T 0.8 A	960127 0800
Relay fuse T 2 A	960127 2000
Lead seal	06 15 000015
Wire for lead seal	9013670303B2

12 Warranty

The warranty of the manufacturer for this product is 24 months after the date of purchase. This warranty shall be good in all countries in which this device is sold by the manufacturer or its authorised dealers.



13 Copyright

The manufacturer retains the copyright to this manual. This manual may only be reprinted, translated, copied in part or in whole with the prior written consent of the manufacturer. We reserve the right to technical modifications with reference to the specifications and illustrations in this manual.

14 Customer satisfaction

Customer satisfaction is our prime objective. Please get in touch with us if you have any questions, suggestions or problems concerning your product.

15 Addresses

The addresses of our worldwide representations and offices can be found on the Internet at www.afriso.de.

16 Appendix

16.1 Certificate of expert

This is to certify that the leak detector was installed, commissioned and function-tested in accordance with these operating instructions:

Pump Off: _____ mbar, Pump ON: _____ mbar

Alarm ON: _____ mbar, Alarm OFF: _____ mbar

Pressure drop complete facility: _____ mbar in _____ minutes

Tank according to DIN _____, year of manufacture: _____, litres: _____

Factory no.: _____, aboveground, underground

Tank manufacturer: _____

Specialised company: _____

Owner: _____

Location of system: _____

Date: _____, Signature: _____



16.2 List of substances for LAZ-04/1

#	(ID #) DIN 6601	Designation of substance	WDC
1		Used oils	3
2		Used motor and gearbox oils	
3		Hydraulic oils HL and HLP DIN 51524, DIN 51525	
4		Silicone oils	
5		Lubricating oils DIN 51501, DIN 51511, DIN 51512	2
6		Thermal oils Q DIN 51522	
7		Transformer oils (clophene)	
8		Collected oil separator concentrate from compressor operation	
9		Used cutting oil (drilling) emulsion	
10		Cutting oils (drilling)	
11		Spindle oils	
12		Cutting oil	
13		Cooling agents from grinding processes	
14	(3393)	Gasoil, flash point > 100 °C boiling point > 200 °C	
15	(3224)	Shale oils, flash point > 100 °C boiling point > 100 °C	
16	(3230)	Turpentine substit., flash point > 100 °C boiling point > 100 °C	
17	(3176)	Brake fluid, hydraulic, flash point > 100 °C	
18		Glysatin, antifreeze	1
19		Ethylglycol, flash point > 100 °C	1
20		Diethylene glycol	1
21		Ethylene glycol	
22		Methylglycol	1
23		Adipic acid dinitrile	1
24		Arsenic acid, aqueous solution	3
25		Benzotrichloride	1
26		Boric acid	1
27		Butylene phenol, liquid	1



#	(ID #) DIN 6601	Designation of substance	WDC
28		Calcium chlorate aqueous solution max. 65 %, flash point > 100 °C	2
29		Calcium hydroxide	1
30		Calcium nitrate	1
31		Diphenyles	2
32		Iron(III) chloride sulfate solution	1
33		Iron(III) chloride solution saturated	1
34		Iron(II) chloride solution saturated	1
35		Iron(II) sulfate solution saturated	1
36	(3193)	Extracts, aromatic substances in alc. sol., boiling point > 100 °C	
37	(3188) (3189)	Extracts, odorous substances in alc. solution, boiling point > 100 °C	
38		Fluoroacetic acid	2
39		Formaldehydes	2
40	(443) (445)	Formaldehydes with methanol concentration < 15 %, flash point > 55° boiling point 96 °C	
41	(607)	Freon	2
42	(609)	Frigen	2
43		Urea, dissolved	1
44	(3085)	Resins dissolved in hydrocarbon without alcohol, flash point > 100 °C, boiling point > 100°	
45		Potassium chloride	0
46		Potassium hydroxide aqueous solution max. 20 %	1
47		Potassium nitrate aqueous solutions	1
48		Potassium sulfide	2
49		Hydrocarbons and mixtures, flash point > 100 °C	
50		Magnesium chlorate solutions	2
51		Magnesium nitrate solutions	1
52		Sodium acetate solutions	1
53		Sodium chloride solutions	0



#	(ID #) DIN 6601	Designation of substance	WDC
54		Sodium fluoride solutions	1
55		Sodium hydroxide solutions, flashpoint > 100 °C	1
56		Sodium nitrate	1
57		Sodium thiosulfate	0
58		Silver nitrate	3
59		Soap, concentrated	2
60		Soap solutions	
61	(3183)	Coal tar distillate, flash point > 100 °C boiling point > 100 °C	
62	(3268)	Coal tar naphtha, flash point > 100 °C boiling point > 100 °C	
63	(3167)	Tars, liquid flash point > 100 °C	
65	(3226)	Tinctures, medical, in alcohol solutions, flash point > 100 °C	
66		Natural linseed oil	0
67		Natural olive oil	0
68		Natural castor oil	0
69		Natural wheat germ oil	0
70		Mineral brine	0



16.3 Approval documents

DEUTSCHES INSTITUT FÜR BAUTECHNIK
Anstalt des öffentlichen Rechts

10259 Berlin, 29. November 2001
Koblenzstraße 301
Telefon: (0 30) 7 87 30 - 315
Telefax: (0 30) 7 87 30 - 320
GeschZ.: III 15-1.65.22-1401

Allgemeine bauaufsichtliche Zulassung

Zulassungsnummer: Z-65.22-4

Antragsteller: Afriso-Euro-Index GmbH
Industrielle ZB
74383 Güglingen

Zulassungsgegenstand: Leckanzeiger für Unterdruck
Bezeichnung "LAZ-04/1"

Geltungsdauer bis: 31. Dezember 2006

Der oben genannte Zulassungsgegenstand wird hiermit allgemein bauaufsichtlich zugelassen. Diese allgemeine bauaufsichtliche Zulassung umfasst sechs Seiten und vier Blatt Anlagen.



DEUTSCHES INSTITUT FÜR BAUTECHNIK
Anstalt des öffentlichen Rechts

10259 Berlin, 8. Januar 2007
Koblenzstraße 301
Telefon: (0 30) 7 87 30 - 384
Telefax: (0 30) 7 87 30 - 320
GeschZ.: I 54-1.65.22-7306

Beschied
über
die Verlängerung der Geltungsdauer
der allgemeinen bauaufsichtlichen Zulassung vom 28. November 2001

Zulassungsnummer: Z-65.22-4

Antragsteller: Afriso-Euro-Index GmbH
Industrielle ZB
74383 Güglingen

Zulassungsgegenstand: Leckanzeiger für Unterdruck
Bezeichnung "LAZ-04/1"

Geltungsdauer bis: 31. Dezember 2011

Dieser Beschied verlängert die Geltungsdauer der allgemeinen bauaufsichtlichen Zulassung Nr. Z-65.22-4 vom 28. November 2001. Dieser Beschied umfasst eine Seite. Er gilt nur in Verbindung mit der oben genannten allgemeinen bauaufsichtlichen Zulassung und darf nur zusammen mit dieser verwendet werden.

Leichensinnung



0401/05



I. ALLGEMEINE BESTIMMUNGEN

- 1 Mit der allgemeinen bauaufsichtlichen Zulassung ist die Verwendbarkeit bzw. Anwendbarkeit des Zulassungsgegenstandes im Sinne der Landesbauordnungen nachgewiesen.
- 2 Die allgemeine bauaufsichtliche Zulassung ersetzt nicht die für die Durchführung von Bauverfahren, gesetzlich vorgeschriebenen Genehmigungen, Zustimmungen und Bescheinigungen.
- 3 Die allgemeine bauaufsichtliche Zulassung wird unbeschadet der Rechte Dritter, insbesondere privater Schutzrechte, erteilt.
- 4 Hersteller und Verreiber des Zulassungsgegenstands haben, unbeschadet weitergehender Regelungen in den "Besonderen Bestimmungen", dem Verwender bzw. Anwender des Zulassungsgegenstands Kopien der allgemeinen bauaufsichtlichen Zulassung zur Verfügung zu stellen und darauf hinzuweisen, dass die allgemeine bauaufsichtliche Zulassung an der Verwendungsstelle vorliegen muss. Auf Anforderung sind den beteiligten Behörden Kopien der allgemeinen bauaufsichtlichen Zulassung zur Verfügung zu stellen.
- 5 Die allgemeine bauaufsichtliche Zulassung darf nur vollständig vervollföhigt werden. Eine auszugsweise Veröffentlichung bedarf der Zustimmung des Deutschen Instituts für Bautechnik. Texte und Zeichnungen von Werbeschriften dürfen der allgemeinen bauaufsichtlichen Zulassung nicht widersprechen. Übersetzungen der allgemeinen bauaufsichtlichen Zulassung müssen den Hinweis "Vom Deutschen Institut für Bautechnik nicht geprüfte Übersetzung der deutschen Originalfassung" enthalten.
- 6 Die allgemeine bauaufsichtliche Zulassung wird widerrufenlich erteilt. Die Bestimmungen der allgemeinen bauaufsichtlichen Zulassung können nachträglich ergänzt und geändert werden, insbesondere, wenn neue technische Erkenntnisse dies erfordern.



II. BESONDERE BESTIMMUNGEN

- 1 **Zulassungsgegenstand und Anwendungsbereich**
 - 1.1 Gegenstand dieser allgemeinen bauaufsichtlichen Zulassung ist ein Unterdruck-Leckanzeiger vom Typ „LAZ-04/1“, der sich aus einem Vakuumpumpe, einem Druckschalter und einem Druckschaltrelais zusammensetzt. Die Druckschalter und Druckschaltrelais sind bauaufsichtlich genehmigt. Die Zulassung umfasst die Zulassung des Überwachungsraumes erzeugt Druckentlastung, der optisch und akustisch angezeigt wird (Aufbau des Leckanzeigers siehe Anlage 1).
 - 1.2 Der Unterdruck-Leckanzeiger der Typbezeichnung "LAZ-04/1" mit einem Alarmierdruck von > 322 mbar darf nur dann für Überwachungsräume doppelwandiger Behälter aus Stahl oder Kunststoff eingesetzt werden, wenn der Überwachungsraum für den Anschluss dieses Leckanzeigertyps ausgewiesen ist. Das sind im Wesentlichen Überwachungsräume von Behältern nach DIN 6608-2, nach DIN 6616, nach DIN 6615-2, nach DIN 6618-4, nach DIN 6619-2, nach DIN 6623-2 und nach DIN 6624-2 mit bauaufsichtlichen Verwendbarkeitsnachweise nach den laufenden Nummern 15.2, 15.3, 15.4, 15.8, 15.10 und 15.12 der Baureihe A Teil 1 (ohne Leckanzeigerzulassung) oder solche von Bautechnik allgemein anerkannt. Der Leckanzeiger darf auch für Behälter mit einer Leckschutzkleidung oder einer Leckschutzummantelung angeschlossen werden. Der Überwachungsraum muss für wassergefährdende Flüssigkeiten mit einem Flammpunkt > 55 °C, unter Berücksichtigung der jeweils zulässigen Flüssigkeitsdichte und des jeweils maximal zulässigen Unterdrucks im Überwachungsraum des Behälters, geeignet sein. Die wassergefährdenden Flüssigkeiten dürfen weder zur Dickflüssigkeit noch zur Feststoffausscheidung neigen.
 - 1.3 Mit dieser allgemeinen bauaufsichtlichen Zulassung wird nur der Nachweis der Funktionalität des Zulassungsgegenstandes im Sinne von Abschnitt 1.1 erbracht.
 - 1.4 Die allgemeine bauaufsichtliche Zulassung wird unbeschadet der Prüf- oder Genehmigungsverfahren anderer Rechtsbereiche (z.B. 1. Verordnung zum Gerätesicherheitsgesetz - Niederspannungsrichtlinie -, Gesetz über die elektromagnetische Verträglichkeit von Geräten - EMVG-Richtlinie -, 11. Verordnung zum Gerätesicherheitsgesetz - Explosionschutzverordnung -) erteilt.
 - 1.5 Durch diese allgemeine bauaufsichtliche Zulassung erteilt für den Zulassungsgegenstand die wasserrechtliche Einstufungsteilung und Bauanzulassung nach § 19 (1) des Wasserhaushaltsgesetzes.
- 2 **Bestimmungen für das Bauprodukt**
 - 2.1 **Zusammensetzung**
 - 2.1.1 Der Unterdruck-Leckanzeiger vom Typ "LAZ-04/1" setzt sich zusammen aus drei Anzeige- und Bedienelementen, der Vakuumpumpe, dem Druckschalter und den elektronischen Komponenten zur Aufbereitung des Ausgangssignals.
 - 2.1.2 Der Nachweis der Funktionsicherheit des Zulassungsgegenstandes im Sinne von Abschnitt 1.1 wurde nach den Zulassungsgrundsätzen für Leckanzeigergeräte für Behälter (ZS-LAGB) des Deutschen Instituts für Bautechnik vom August 1994 erbracht.
 - 2.2 **Herstellung und Kennzeichnung**
 - 2.2.1 Herstellung
Der Unterdruck-Leckanzeiger vom Typ "LAZ-04/1" darf nur im Werk des Antragstellers hergestellt werden. Er muss hinsichtlich Bauart, Abmessungen und Werkstoffen den in der Anlage 3 dieser allgemeinen bauaufsichtlichen Zulassung aufgeführten Unterlagen entsprechen.



Seite 4 der allgemeinen bauaufsichtlichen Zulassung Nr. Z-65.22-4 vom 28. November 2001

2.2.2 Kennzeichnung

Der Unterdruck-Leckanzeiger vom Typ "LAZ-04/1", dessen Verpackung oder dessen Aufschrift das Wort "Leckanzeiger" enthält, muss mit dem Namen des Herstellers und dem Übersetzungstext des Besondereingetragenen in deutscher Sprache versehen sein. Die Kennzeichnung darf nur erfolgen, wenn die Voraussetzungen nach Abschnitt 2.3 erfüllt sind. Darüber hinaus ist der Leckanzeiger mit folgenden Angaben zu versehen:

Typbezeichnung,
Zulassungsnummer.

2.3 Übereinstimmungsnachweis

2.3.1 Allgemeines

Die Bestätigung der Übereinstimmung des Unterdruck-Leckanzeigers vom Typ "LAZ-04/1" mit den Bestimmungen dieser allgemeinen bauaufsichtlichen Zulassung muss im Herstellwerk mit einer Übereinstimmungserklärung des Herstellers auf der Grundlage einer werkseigenen Produktionskontrolle und einer Erprobung des Leckanzeigers durch eine hierfür anerkannte Prüfstelle erfolgen.

2.3.2 Werkseigene Produktionskontrolle

Im Herstellwerk ist eine werkseigene Produktionskontrolle einzurichten und durchzuführen.

Im Rahmen der werkseigenen Produktionskontrolle ist eine Stückprüfung jedes Leckanzeigers oder dessen Einzelteile durchzuführen. Durch eine Stückprüfung hat der Hersteller zu gewährleisten, dass die Bauteile, die für die Herstellung des Leckanzeigers verwendet werden, den Bauartanforderungen entsprechen und der Leckanzeiger funktionsfähig ist. Die Ergebnisse der werkseigenen Produktionskontrolle sind aufzuzeichnen und auszuwerten. Die Aufzeichnungen müssen mindestens folgende Angaben enthalten:

- Bezeichnung des Leckanzeigers,
- Art der Kontrolle oder Prüfung,
- Datum der Herstellung und der Prüfung des Leckanzeigers,
- Ergebnisse der Kontrollen oder Prüfungen,
- Unterschrift des für die werkseigene Produktionskontrolle Verantwortlichen.

Die Aufzeichnungen sind mindestens fünf Jahre aufzubewahren. Sie sind dem Deutschen Institut für Bautechnik und der obersten Bauaufsichtsbehörde auf Verlangen vorzulegen. Bei ungenügender Prüfergebnisse sind vom Hersteller unverzüglich die erforderlichen Maßnahmen zur Abstellung des Mangels zu treffen. Ein Leckanzeiger, der den Anforderungen nicht entspricht, ist so zu handhaben, dass eine Verweildauer mit Übersummenungen im Zusammenhang mit dem Nachweis der Mängelbeseitigung erforderlich - die sowohl technisch möglich und zum Nachweis der Mängelbeseitigung erforderlich - die betreffende Prüfung unverzüglich zu wiederholen.

2.3.3

Erprobung des Leckanzeigers durch eine anerkannte Prüfstelle
Im Rahmen der Erprobung sind die in den Zulassungsgrundsätzen für Leckanzeiger für Behälter aufgeführten Funktionssprüfungen durchzuführen. Wenn die der allgemeinen bauaufsichtlichen Zulassung zugrundeliegenden Nachweise am Proben aus der laufenden Produktion erbracht wurden, ersetzen diese Prüfungen die Erprobung.

3 Bestimmungen für den Entwurf

3.1 Der Überwachungsraum muss gegen die zu lagernden Flüssigkeiten beständig sein und für den jeweils maximal zulässigen Betriebsdruck des Behälters geeignet sein; das ist entsprechend Abschnitt 1.2 mitzuzuwachen.

3.2 Der Anwendungsbereich des Leckanzeigers vom Typ "LAZ-04/1" ist auf folgende Behälter beschränkt:

Seite 5 der allgemeinen bauaufsichtlichen Zulassung Nr. Z-65.22-4 vom 28. November 2001

- doppelwandige Behälter aus Stahl nach DIN 6609-21 nach DIN 6616 Form A2, nach DIN 6619-23, nach DIN 6618-45, nach DIN 6619-25, nach DIN 6622-26 oder nach DIN 6624-27, in abhängigkeit vom Inhalt sind folgende Dichten zulässig:
- Behälter nach DIN 6609-21 nach DIN 6616 Form A2, nach DIN 6619-25 nach DIN 6622-26 und nach DIN 6624-27 bis zu 1,90 kg/m³,
- Behälter nach DIN 6618-23 und nach DIN 6616-44:

- mit ≤ 100 m³ Rauminhalt, bis zu 1,30 kg/m³,
- mit ≤ 80 m³ Rauminhalt, bis zu 1,69 kg/m³,
- mit ≤ 60 m³ Rauminhalt, bis zu 1,90 kg/m³.

- doppelwandige Behälter mit allgemeiner bauaufsichtlicher Zulassung in Verbindung des Überwachungsraumes für den Anschluss eines Leckanzeigers für Überdrucksysteme mit 325 mbar Alarmlenker ausgewiesen ist.

Der Leckanzeiger muss hinreichend gegen die zu lagernde Flüssigkeit beständig sein. Die Beständigkeit ist für Flüssigkeiten nachgewiesen, die in der Stoffliste zum Leckanzeiger LAZ-04/1 gemäß der Anlage 2 aufgeführt sind.

4 Bestimmungen für die Ausführung

4.1 (1) Der Unterdruck-Leckanzeiger vom Typ "LAZ-04/1" muss entsprechend Abschnitt 6 der Betriebsanleitung eingebaut und entsprechend deren Abschnitt 7 in Betrieb genommen werden. Mit dem Einbau, Instandhalten, Instandsetzen und Reinigen des Leckanzeigers dürfen nur solche Betriebe beauftragt werden, die für diese Tätigkeiten Fachbetriebe im Sinne von § 19 i. Wasserhaushaltsgesetz (WHG) sind.

(2) Die Tätigkeiten nach (1) müssen nicht von Fachbetrieben ausgeführt werden, wenn sie nach landestypischen Vorschriften von der Fachbetriebspflicht ausgenommen sind oder der Hersteller des Zulassungsgegenstandes die Tätigkeiten mit eigenem sachkundigen Personal ausführt. Die ansonst üblichen Anforderungen müssen eingehalten werden.

4.2 Der Unterdruck-Leckanzeiger vom Typ "LAZ-04/1" darf nicht im Ex-Bereich montiert und betrieben werden.

4.3 Der Unterdruck-Leckanzeiger vom Typ "LAZ-04/1" muss in einem trockenen Raum oder in einem trockenen Behälter (Tank) aus Stahl, doppelwandig, mit einer unterirdischen Flüssigkeit gefüllt werden. Die unterirdische Flüssigkeit muss in einem trockenen Raum befüllbar sein, muss er in einem Spezialkasten oder nichtbrennbar eingemietet werden, der mindestens der Schutzart IP 54 entspricht. Der Spezialkasten muss mit

1	DIN 6609-2:	Liegende Behälter (Tanks) aus Stahl, doppelwandig, für die unterirdische Lagerung wassergetriebener, brennbarer und nichtbrennbarer Flüssigkeiten -Ausgabe September 1989 - Form A
2	DIN 6616:	Siehe oben, Behälter (Tanks) aus Stahl, doppelwandig, für die oberirdische Lagerung wassergetriebener, brennbarer und nichtbrennbarer Flüssigkeiten -Ausgabe September 1989 - Form A
3	DIN 6618-2:	Siehe oben, Behälter (Tanks) aus Stahl, doppelwandig, ohne Leckanzeigerfähigkeit für die Lagerung wassergetriebener, brennbarer und nichtbrennbarer Flüssigkeiten -Ausgabe September 1989.
4	DIN 6618-4:	Siehe oben, Behälter (Tanks) aus Stahl, doppelwandig, ohne Leckanzeigerfähigkeit, mit Flammgefahr, Behälter (Tanks) aus Stahl, doppelwandig, für die oberirdische Lagerung brennbarer Flüssigkeiten -Ausgabe Februar 1984.
5	DIN 6619-2:	Siehe oben, Behälter (Tanks) aus Stahl, doppelwandig, für die unterirdische Lagerung wasser-getriebener, brennbarer und nichtbrennbarer Flüssigkeiten -Ausgabe September 1989.
6	DIN 6622-2:	Siehe oben, Behälter (Tanks) aus Stahl, doppelwandig, mit weniger als 1000 Liter Volumen, für die oberirdische Lagerung wassergetriebener, brennbarer und nichtbrennbarer Flüssigkeiten -Ausgabe September 1989.
7	DIN 6624-2:	Liegende Behälter (Tanks) aus Stahl von 1000 bis 5000 Liter Volumen, doppelwandig, für die oberirdische Lagerung wassergetriebener, brennbarer und nichtbrennbarer Flüssigkeiten -Ausgabe September 1989.
8	Vom TÜV Nord s.V. geprüfte Betriebsanleitung des Unterdruck-Leckanzeigers Typ "LAZ-04/1" des Antragstellers vom 4. September 1990.	



Seite 6 der allgemeinen bauaufsichtlichen Zulassung Nr. Z-65.22-4 vom 28. November 2001

einer thermostatgesteuerten Heizung ausgenüzt sein, die ein Abkühlen des Leckanzeigers auf unter -5 °C verhindert. Bei Montage in einem Schutzkasten ist zusätzlich ein akustischer Außen-Alarmleider einzubauen.

5 Bestimmungen für Nutzung, Unterhalt, Wartung und wiederkehrende Prüfung

- 5.1 Ein Leckanzeiger mit einem Unterdruck-Leckanzeiger vom Typ „LAZ-041“ muss entsprechend Abschnitt 6 der Betriebsanleitung¹⁾ betrieben und entsprechend Abschnitt 8.2 der Betriebsanleitung²⁾ gewartet werden. Die Betriebsanleitung³⁾ ist vom Hersteller mitzuliefern.
- 5.2 Die Funktionsprüfung ist in Abschnitt 8.3 der Betriebsanleitung⁴⁾ beschrieben.

Im Auftrag
Strassas

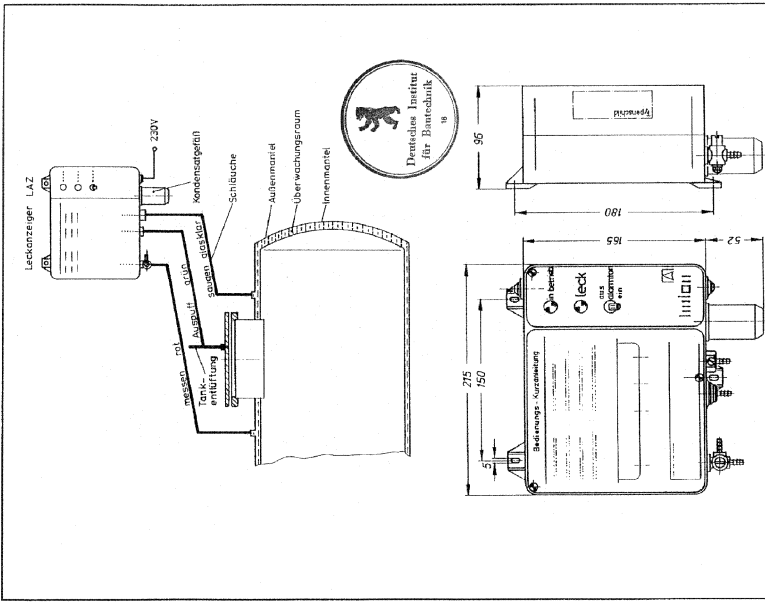

Antragsteller:
AFFISO-EURO-INDEX GmbH
Lindenstrasse 20
74363 Guglingen
Tel.: 07195 / 102-0
Fax.: 07195 / 102-147

Zulassungsgegenstand:
Unterdruck-Leckanzeiger
Typ: LAZ-041
Leckanzeiger für Unterdrucksysteme.

Anlage 1:
zur allgemeinen bauaufsichtlichen Zulassung:
Z-65.22-4
vom: **28. November 2001**



Appendix 2
List of substances for LAZ-04/1
 Refer to chapter 16.2., page 28.

Prüfungsunterlagen für den Leckanzeiger Typ LAZ-04/1:

Bezeichnung	Zeichn.-Nr.	Blatt	Datum
Technische Beschreibung	TB 09 20 04 A	Bl. 1-7	04.09.1990
Technische Beschreibung	TB 09 20 04 B	Bl. 1-2	04.09.1990
Technische Beschreibung	TB 09 20 04 C	Bl. 1-5	04.09.1990
Stückliste LAZ-04/1	09 20 03	Bl. 1-3	12.10.1995
Schalplan LAZ/LAD	09 20 040902	Bl. 1	19.09.95
Bestückungsplan LAZ/LAD	09 20 040907	Bl. 1	12.10.95
Layout LAZ/LAD	09 20 040993	Bl. 1	12.10.95



Antragsteller: AFRISO-EUIRO-INDEX GmbH Lrdenstrasse 20 74363 Güglingen Tel.: 07195 / 102-0 Fax: 07195 / 102-147	Zulassungsgegenstand: Unterdruck-Leckanzeiger Typ: LAZ-04/1 Leckanzeiger für Unterdrucksysteme.	Anlage 3: zur allgemeinen bauaufsichtlichen Zulassung: Z-65.22-4 vom: 28. November 2001
---------------------------------------------------------------------------------------------------------------------------------------	------------------------------------------------------------------------------------------------------------------------	-----------------------------------------------------------------------------------------------------------------------





Eidgenössisches Strikstrominspektorat
 Inspection federate des installations à courant fort
 Ispettorato federate degli impianti a corrente forte
 Federal Inspectorate for Heavy Current Installations



Zertifizierungsstelle
 B Bewilligung
 S Sicherheitszeichen
 SCSES 033

Seite 2

Nummer: **06.0939**

Prüfnummer:
 EN 60730-1:2005
 EN 55014-1:1993
 EN 55014-2:1997
 EN 61004-2:1995
 EN 61004-3:1995
 EN 61004-4:1995
 EN 61004-5:1995

AFRISO-EURO-INDEX AG
 Industrieanlage 11
 91434 Au SG

Kundennummer: 1549 Ihr Zeichen: Hubert Fitz
 Unser Zeichen: spa Datum: 21.12.2009

Bewilligung

Nummer: **06.0939**
 gültig bis: **20.12.2009**
 Kennzeichnung: **JA 2**

Aufgrund der Unterlagen im Dossier Nr. **06-BS-0438** erteilt das Eidgenössische Strikstrominspektorat der oben genannten Firma das Recht nachstehend(s) Erzeugnis(ese) mit dem Sicherheitszeichen gekennzeichnet, gemäss NEV, in Verkehr zu bringen.

Erzeugnis: **Leckanzagegerät**
 Handelsmarken: **EUROVAC**

Typenbezeichnung: Nemidelen
LAZ-041
LAZ-043
 230 V~ 80 VA Alarm: 325mbar
 230 V~ 80 VA Alarm: 5mbar

Schutzklasse: II
 Schutzgrad: IP 30
 Technischer Bericht: TÜV Süd / 028-717313552-000 vom 05.12.2006
 EMC TR / MKNES BAB7 / W 20260-0-00 NA vom 10.04.2001
 EMC TR / TÜV PS / EV-F 8601607 860152 vom 06.04.1999

Bemerkung:

Qualitätsmanagement
 C-150311 Fernstud
 Tel: +41 692 12 12
 Email: info@afri-so.ch

Einzelstelle
 C-150311 Fernstud
 Tel: +41 692 12 12
 Email: info@afri-so.ch