

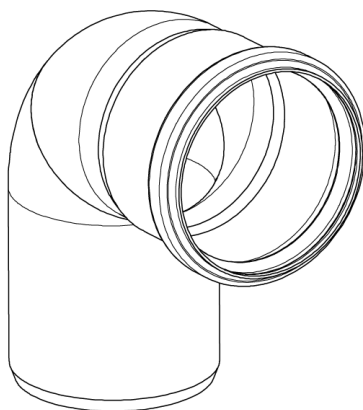

BEND 87.5°, Ø75MM
- Rustfritt stål: AISI304/EN1.4301

Type nr.: 820.090.075
EAN nr.: 5705499401400
VVS nr.: 160201075
RSK nr.: 1550086
NRF nr.: 2170065
LVI nr.: 0240833

Type: Bend
Utløpsdia. (mm): 75
Vinkel (°): 87,5
Vekt (kg): 0,39
Materiale: AISI 304
Materiale: EN 1.4301

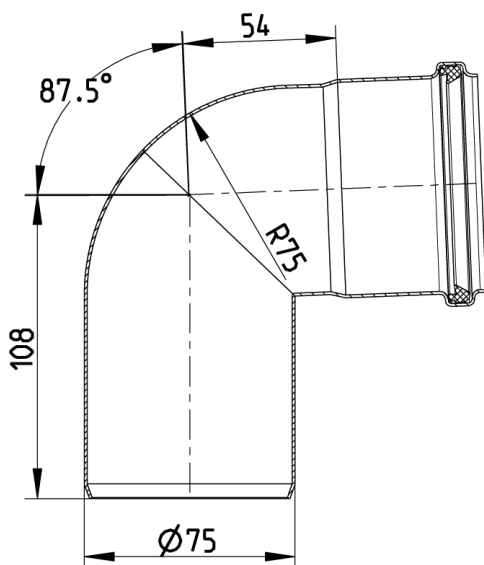

Godkjenninger

ABS - 04-LD472768/3
Achilles - 25316-17
AUS - WMKT00204 - 18
Bureau Veritas - 02375-G0
DE - LGA Certificate 57214035 a
DK - VA 2.12/19349-16
DNV - TAP0000023-rev1
FR - DTA 14/12-1811*V1 EuroPipe
Lloyds Register 92-00041 (E6)
MARINE - R4547 NATO CODIFICATION SYSTEM
NO - 0692-12
PL - Hygenic Certificate - All products
RINA - MAC128714XG EuroPipe
RS - 14.10112.262
RU - 1682258
SE - SITAC 4423/90
UK - BBA 86-1751 EuroPipe
UR - 1055745
US - IAPMO File No.3247-16