

Public-law institution jointly founded by the federal states and the Federation

European Technical Assessment Body
for construction products



European Technical Assessment

ETA-10/0167
of 19 April 2024

English translation prepared by DIBt - Original version in German language

General Part

Technical Assessment Body issuing the European Technical Assessment:

Deutsches Institut für Bautechnik

Trade name of the construction product

SOUDAFIX VE400-SF, SOUDAFIX VE400-SF ARCTIC

Product family
to which the construction product belongs

Injection system for use in concrete

Manufacturer

SOUDAL N.V.
Everdongenlaan 18-20
2300 Turnhout
BELGIEN

Manufacturing plant

Soudal NV, Plant1 Germany

This European Technical Assessment
contains

31 pages including 3 annexes which form an integral part
of this assessment

This European Technical Assessment is
issued in accordance with Regulation (EU)
No 305/2011, on the basis of

EAD 330499-01-0601, Edition 04/2020

This version replaces

ETA-10/0167 issued on 16 May 2018

The European Technical Assessment is issued by the Technical Assessment Body in its official language. Translations of this European Technical Assessment in other languages shall fully correspond to the original issued document and shall be identified as such.

Communication of this European Technical Assessment, including transmission by electronic means, shall be in full. However, partial reproduction may only be made with the written consent of the issuing Technical Assessment Body. Any partial reproduction shall be identified as such.

This European Technical Assessment may be withdrawn by the issuing Technical Assessment Body, in particular pursuant to information by the Commission in accordance with Article 25(3) of Regulation (EU) No 305/2011.

Specific Part

1 Technical description of the product

The "SOUDAFIX VE400-SF, SOUDAFIX VE400-SF ARCTIC" is a bonded anchor consisting of a cartridge with injection mortar SOUDAFIX VE400-SF or SOUDAFIX VE400-SF ARCTIC and a steel element. The steel element consists of a commercial threaded rod with washer and hexagon nut in the range of M8 to M30 or reinforcing bar in the range of \varnothing 8 to \varnothing 32 mm or an internal threaded anchor rod IG-M6 to IG-M20.

The steel element is placed into a drilled hole filled with injection mortar and is anchored via the bond between metal part, injection mortar and concrete.

The product description is given in Annex A.

2 Specification of the intended use in accordance with the applicable European Assessment Document

The performances given in Section 3 are only valid if the fastener is used in compliance with the specifications and conditions given in Annex B.

The verifications and assessment methods on which this European Technical Assessment is based lead to the assumption of a working life of the fastener of at least 50 years. The indications given on the working life cannot be interpreted as a guarantee given by the producer, but are to be regarded only as a means for choosing the right products in relation to the expected economically reasonable working life of the works.

3 Performance of the product and references to the methods used for its assessment

3.1 Mechanical resistance and stability (BWR 1)

Essential characteristic	Performance
Characteristic resistance to tension load (static and quasi-static loading)	See Annex B 3, C 1, C 2, C 3, C 5 and C 7
Characteristic resistance to shear load (static and quasi-static loading)	See Annex C 1, C 4, C 6 and C 8
Displacements (static and quasi-static loading)	See Annex C 9 to C 11
Characteristic resistance for seismic performance categories C1	See Annex C 12 and C 13
Characteristic resistance and displacements for seismic performance categories C2	No performance assessed

3.2 Hygiene, health and the environment (BWR 3)

Essential characteristic	Performance
Content, emission and/or release of dangerous substances	No performance assessed

4 Assessment and verification of constancy of performance (AVCP) system applied, with reference to its legal base

In accordance with the European Assessment Document EAD 330499-01-0601 the applicable European legal act is: [96/582/EC].

The system to be applied is: 1

5 Technical details necessary for the implementation of the AVCP system, as provided for in the applicable European Assessment Document

Technical details necessary for the implementation of the AVCP system are laid down in the control plan deposited at Deutsches Institut für Bautechnik.

Issued in Berlin on 19 April 2024 by Deutsches Institut für Bautechnik

Dipl.-Ing. Beatrix Wittstock
Head of Section

beglaubigt:
Baderschneider

Installation threaded rod M8 up to M30

prepositioned installation or
push through installation (annular gap filled with mortar)

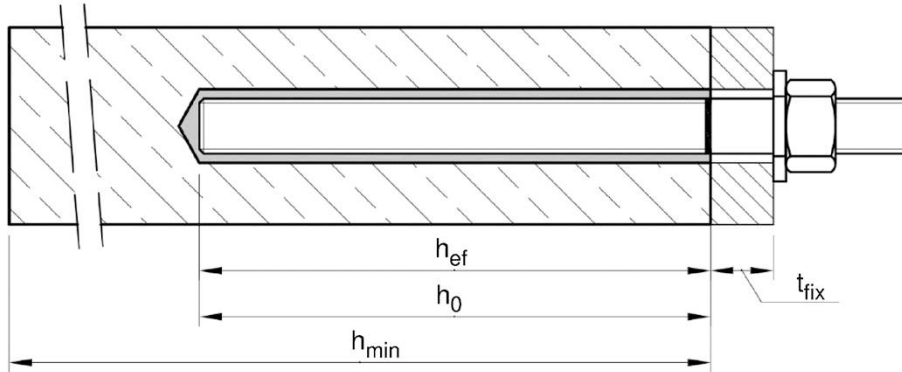

Installation reinforcing bar Ø8 up to Ø32

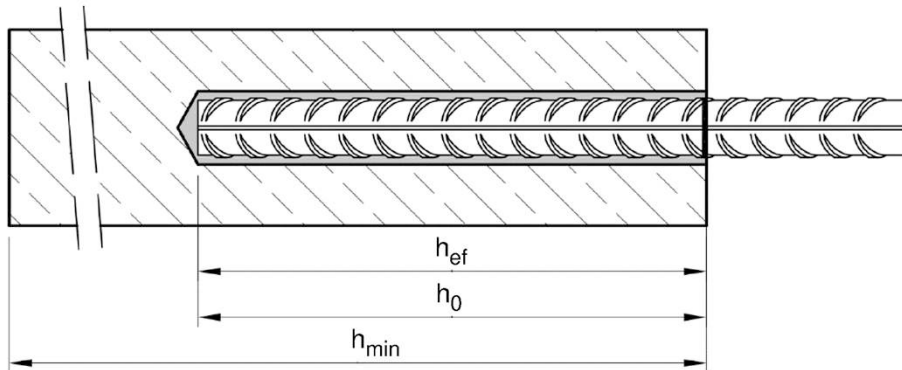

Installation internal threaded anchor rod IG-M6 up to IG-M20

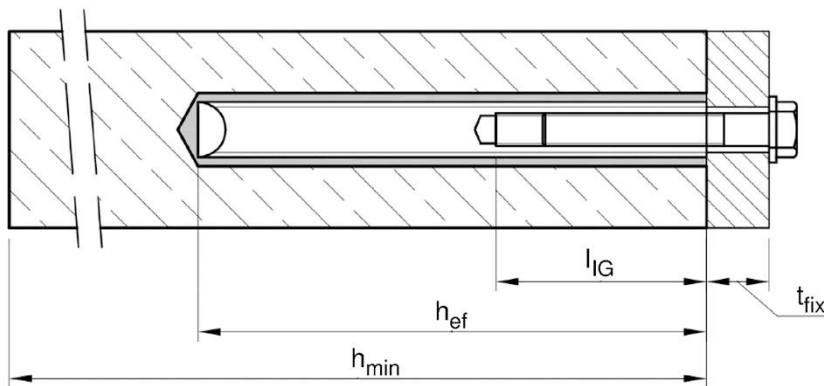

t_{fix} = thickness of fixture
 h_{ef} = effective embedment depth
 h_{min} = minum thickness of member

h_0 = nominal drill hole diameter
 l_{IG} = thread engagement length

SOUDAFIX VE400-SF, SOUDAFIX VE400-SF ARCTIC

Product description
Installed condition

Annex A 1

Cartridge system

Coaxial Cartridge:

150 ml, 280 ml, 300 ml up to 333 ml and 380 ml up to 420 ml

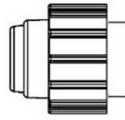

Imprint:

SOUDAFIX VE400-SF or SOUDAFIX VE400-SF ARCTIC

Processing and safety instructions, shelf life, charge number, manufacturer's information, quantity information

Side-by-Side Cartridge:

235 ml, 345 ml up to 360 ml and 825 ml

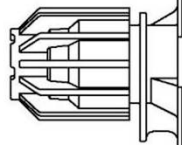

Imprint:

SOUDAFIX VE400-SF or SOUDAFIX VE400-SF ARCTIC

Processing and safety instructions, shelf life, charge number, manufacturer's information, quantity information

Foil tube Cartridge:

165 ml and 300 ml

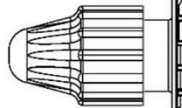

Imprint:

SOUDAFIX VE400-SF or SOUDAFIX VE400-SF ARCTIC

Processing and safety instructions, shelf life, charge number, manufacturer's information, quantity information

Static mixer CRW 14W

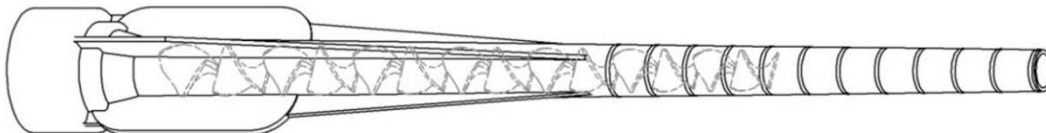

Static mixer PM-19E

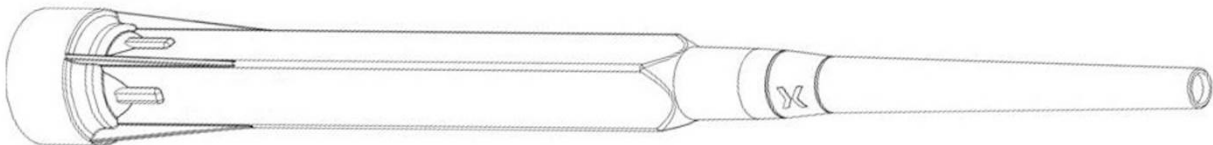

Piston plug VS and mixer extension VL



SOUDAFIX VE400-SF, SOUDAFIX VE400-SF ARCTIC

Product description

Injection system

Annex A 2

Threaded rod M8 up to M30 with washer and hexagon nut

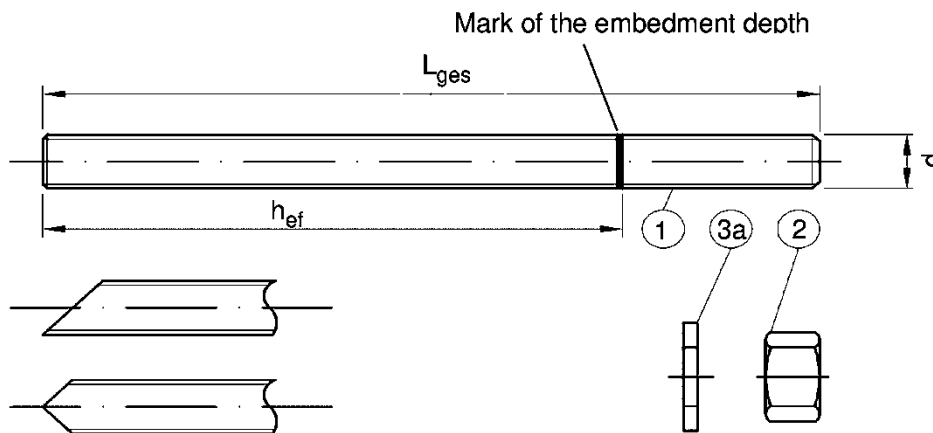



Commercial standard rod with:

- Materials, dimensions and mechanical properties acc. to Table A1
- Inspection certificate 3.1 acc. to EN 10204:2004. The document shall be stored.
- Marking of embedment depth

Internal threaded rod IG-M6 to IG-M20

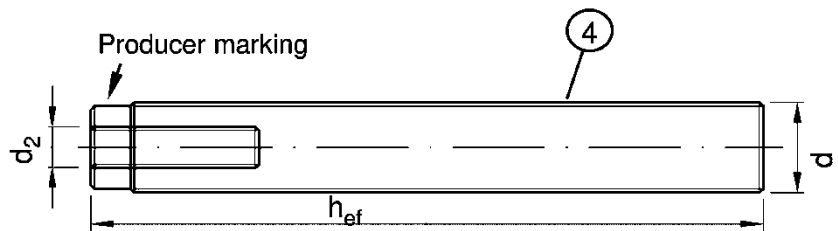
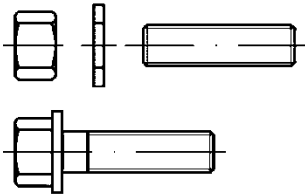
Threaded rod or screw



Producer marking: e.g.  M8

 Marking Internal thread

 Mark

M8 Thread size (Internal thread)

A4 additional mark for stainless steel

HCR additional mark for high-corrosion resistance steel

Filling washer VFS

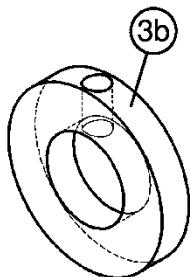

Mixer reduction nozzle MR

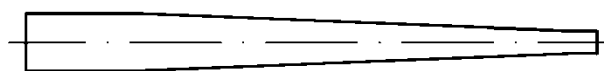

SOUDAFIX VE400-SF, SOUDAFIX VE400-SF ARCTIC

Product description

Threaded rod; Internal threaded rod
Filling washer; Mixer reduction nozzle

Annex A 3

Table A1: Materials

Part	Designation	Material				
Steel, zinc plated (Steel acc. to EN ISO 683-4:2018 or EN 10263:2017)						
- zinc plated $\geq 5 \mu\text{m}$ acc. to EN ISO 4042:2022 or						
- hot-dip galvanized $\geq 40 \mu\text{m}$ acc. to EN ISO 1461:2022 and EN ISO 10684:2004+AC:2009 or						
- sherardized $\geq 45 \mu\text{m}$ acc. to EN ISO 17668:2016						
1	Threaded rod	Property class	Characteristic steel ultimate tensile strength	Characteristic steel yield strength	Elongation at fracture	
		acc. to EN ISO 898-1:2013	4.6	$f_{uk} = 400 \text{ N/mm}^2$	$f_{yk} = 240 \text{ N/mm}^2$	$A_5 > 8\%$
			4.8	$f_{uk} = 400 \text{ N/mm}^2$	$f_{yk} = 320 \text{ N/mm}^2$	$A_5 > 8\%$
			5.6	$f_{uk} = 500 \text{ N/mm}^2$	$f_{yk} = 300 \text{ N/mm}^2$	$A_5 > 8\%$
			5.8	$f_{uk} = 500 \text{ N/mm}^2$	$f_{yk} = 400 \text{ N/mm}^2$	$A_5 > 8\%$
8.8	$f_{uk} = 800 \text{ N/mm}^2$	$f_{yk} = 640 \text{ N/mm}^2$	$A_5 \geq 8\%$			
2	Hexagon nut	acc. to EN ISO 898-2:2012	4 for anchor rod class 4.6 or 4.8			
			5 for anchor rod class 5.6 or 5.8			
			8 for anchor rod class 8.8			
3a	Washer	Steel, zinc plated, hot-dip galvanized or sherardized (e.g.: EN ISO 887:2006, EN ISO 7089:2000, EN ISO 7093:2000 or EN ISO 7094:2000)				
3b	Filling washer	Steel, zinc plated, hot-dip galvanized or sherardized				
4	Internal threaded anchor rod	Property class	Characteristic steel ultimate tensile strength	Characteristic steel yield strength	Elongation at fracture	
		acc. to EN ISO 898-1:2013	5.8	$f_{uk} = 500 \text{ N/mm}^2$	$f_{yk} = 400 \text{ N/mm}^2$	$A_5 > 8\%$
			8.8	$f_{uk} = 800 \text{ N/mm}^2$	$f_{yk} = 640 \text{ N/mm}^2$	$A_5 > 8\%$
Stainless steel A2 (Material 1.4301 / 1.4307 / 1.4311 / 1.4567 or 1.4541, acc. to EN 10088-1:2014)						
Stainless steel A4 (Material 1.4401 / 1.4404 / 1.4571 / 1.4362 or 1.4578, acc. to EN 10088-1:2014)						
High corrosion resistance steel (Material 1.4529 or 1.4565, acc. to EN 10088-1: 2014)						
1	Threaded rod ¹⁾³⁾	Property class	Characteristic steel ultimate tensile strength	Characteristic steel yield strength	Elongation at fracture	
		acc. to EN ISO 3506-1:2020	50	$f_{uk} = 500 \text{ N/mm}^2$	$f_{yk} = 210 \text{ N/mm}^2$	$A_5 \geq 8\%$
			70	$f_{uk} = 700 \text{ N/mm}^2$	$f_{yk} = 450 \text{ N/mm}^2$	$A_5 \geq 8\%$
	80	$f_{uk} = 800 \text{ N/mm}^2$	$f_{yk} = 600 \text{ N/mm}^2$	$A_5 \geq 8\%$		
2	Hexagon nut ¹⁾³⁾	acc. to EN ISO 3506-1:2020	50 for anchor rod class 50			
			70 for anchor rod class 70			
			80 for anchor rod class 80			
3a	Washer	A2: Material 1.4301 / 1.4307 / 1.4311 / 1.4567 or 1.4541, acc. to EN 10088-1:2014 A4: Material 1.4401 / 1.4404 / 1.4571 / 1.4362 or 1.4578, acc. to EN 10088-1:2014 HCR: Material 1.4529 or 1.4565, acc. to EN 10088-1: 2014 (e.g.: EN ISO 887:2006, EN ISO 7089:2000, EN ISO 7093:2000 or EN ISO 7094:2000)				
3b	Filling washer	Stainless steel A4, High corrosion resistance steel				
4	Internal threaded anchor rod ¹⁾²⁾	Property class	Characteristic steel ultimate tensile strength	Characteristic steel yield strength	Elongation at fracture	
		acc. to EN ISO 3506-1:2020	50	$f_{uk} = 500 \text{ N/mm}^2$	$f_{yk} = 210 \text{ N/mm}^2$	$A_5 > 8\%$
		70	$f_{uk} = 700 \text{ N/mm}^2$	$f_{yk} = 450 \text{ N/mm}^2$	$A_5 > 8\%$	
1) Property class 70 or 80 for anchor rods and hexagon nuts up to M24 and Internal threaded anchor rods up to IG-M16						
2) for IG-M20 only property class 50						
3) Property class 80 only for stainless steel A4 and HCR						
SOUDAFIX VE400-SF, SOUDAFIX VE400-SF ARCTIC					Annex A 4	
Product description Materials threaded rod and internal threaded rod						

Reinforcing bar: $\varnothing 8$ up to $\varnothing 32$

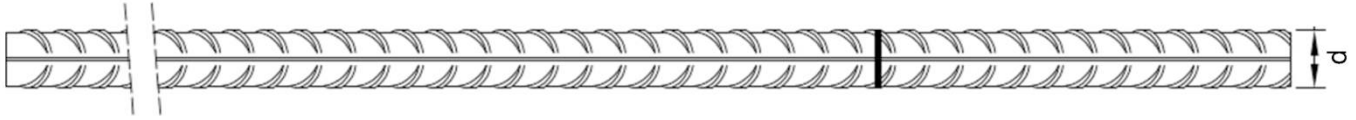

Minimum value of related rip area $f_{R,min}$ according to EN 1992-1-1:2004+AC:2010

Rib height of the bar shall be in the range $0,05d \leq h_{rib} \leq 0,07d$

(d: Nominal diameter of the bar; h_{rib} : Rib height of the bar)

Table A2: Materials Reinforcing bar

Part	Designation	Material
Rebar		
1	Reinforcing steel according to EN 1992 1 1:2004+AC:2010, Annex C	Bars and rebars from ring class B or C f_{yk} and k according to NDP or NCI according to EN 1992-1-1/NA $f_{uk} = f_{tk} = k \cdot f_{yk}$

SOUDAFIX VE400-SF, SOUDAFIX VE400-SF ARCTIC

Product description
Materials reinforcing bar

Annex A 5

Specification of the intended use				
Fasteners subject to (Static and quasi-static loads):				
	Working life 50 years		Working life 100 years	
Base material	uncracked concrete	cracked concrete	Base material	uncracked concrete
HD: Hammer drilling HDB: Hammer drilling with hollow drill bit CD: Compressed air drilling	M8 to M30, Ø8 to Ø32, IG-M6 to IG-M20		No performance assessed	
Temperature Range	I: - 40°C to +40°C ¹⁾ II: - 40°C to +80°C ²⁾ III: - 40°C to +120°C ³⁾		No performance assessed	
Fasteners subject to (seismic action):				
	Performance Category C1		Performance Category C2	
Base material	Cracked and uncracked concrete			
HD: Hammer drilling HDB: Hammer drilling with hollow drill bit CD: Compressed air drilling	M8 to M30, Ø8 to Ø32		No performance assessed	
Temperature Range	I: - 40°C to +40°C ¹⁾ II: - 40°C to +80°C ²⁾ III: - 40°C to +120°C ³⁾		No performance assessed	
<p>1) (max. long-term temperature +24°C and max. short-term temperature +40°C) 2) (max. long-term temperature +50°C and max. short-term temperature +80°C) 3) (max. long-term temperature +72°C and max. short-term temperature +120°C)</p> <p>Base material:</p> <ul style="list-style-type: none"> - Compacted, reinforced or unreinforced normal weight concrete without fibres according to EN 206:2013 + A1:2016. - Strength classes C20/25 to C50/60 according to EN 206:2013 + A1:2016. <p>Use conditions (Environmental conditions):</p> <ul style="list-style-type: none"> - Structures subject to dry internal conditions (all materials). - For all other conditions according to EN 1993-1-4:2006+A1:2015 corresponding to corrosion resistance class: <ul style="list-style-type: none"> • Stainless steel Stahl A2 according to Annex A 4, Table A1: CRC II • Stainless steel Stahl A4 according to Annex A 4, Table A1: CRC III • High corrosion resistance steel HCR according to Annex A 4, Table A1: CRC V 				
SOUDAFIX VE400-SF, SOUDAFIX VE400-SF ARCTIC				Annex B 1
Intended Use Specifications				

Design:

- Verifiable calculation notes and drawings are prepared taking account of the loads to be anchored. The position of the fastener is indicated on the design drawings (e.g. position of the fastener relative to reinforcement or to supports, etc.).
- Fasteners are designed under the responsibility of an engineer experienced in fasteners and concrete work.
- The fasteners are designed in accordance to EN 1992-4:2018 and Technical Report TR 055, Edition February 2018

Installation:

- Dry, wet concrete or flooded bore holes (not sea-water).
- Hole drilling by hammer (HD), hollow (HDB) or compressed air (CD).
- Overhead installation allowed.
- Fastener installation carried out by appropriately qualified personnel and under the supervision of the person responsible for technical matters of the site.
- Installation temperature in concrete:
SOUDAFIX VE400-SF: -10°C up to +40°C for the standard variation of temperature after installation.
SOUDAFIX VE400-SF ARCTIC: -20°C up to +10°C for the standard variation of temperature after installation.

SOUDAFIX VE400-SF, SOUDAFIX VE400-SF ARCTIC

Intended Use
Specifications (Continued)

Annex B 2

Table B1: Installation parameters for threaded rod

Threaded rod			M8	M10	M12	M16	M20	M24	M27	M30
Diameter of element	$d = d_{nom}$	[mm]	8	10	12	16	20	24	27	30
Nominal drill hole diameter	d_0	[mm]	10	12	14	18	22	28	30	35
Effective embedment depth	$h_{ef,min}$	[mm]	60	60	70	80	90	96	108	120
	$h_{ef,max}$	[mm]	160	200	240	320	400	480	540	600
Diameter of clearance hole in the fixture	Prepositioned installation $d_f \leq$	[mm]	9	12	14	18	22	26	30	33
	Push through installation d_f	[mm]	12	14	16	20	24	30	33	40
Maximum installation torque	$\max T_{inst}$	[Nm]	10	20	40	60	100	170	250	300
Minimum thickness of member	h_{min}	[mm]	$h_{ef} + 30 \text{ mm}$ $\geq 100 \text{ mm}$			$h_{ef} + 2d_0$				
Minimum spacing	s_{min}	[mm]	40	50	60	80	100	120	135	150
Minimum edge distance	c_{min}	[mm]	40	50	60	80	100	120	135	150

Table B2: Installation parameters for reinforcing bar

Reinforcing bar			$\varnothing 8^1)$	$\varnothing 10^1)$	$\varnothing 12^1)$	$\varnothing 14$	$\varnothing 16$	$\varnothing 20$	$\varnothing 25^1)$	$\varnothing 28$	$\varnothing 32$
Diameter of element	$d = d_{nom}$	[mm]	8	10	12	14	16	20	25	28	32
Nominal drill hole diameter	d_0	[mm]	10 12	12 14	14 16	18	20	25	32	35	40
Effective embedment depth	$h_{ef,min}$	[mm]	60	60	70	75	80	90	100	112	128
	$h_{ef,max}$	[mm]	160	200	240	280	320	400	500	560	640
Minimum thickness of member	h_{min}	[mm]	$h_{ef} + 30 \text{ mm}$ $\geq 100 \text{ mm}$			$h_{ef} + 2d_0$					
Minimum spacing	s_{min}	[mm]	40	50	60	70	80	100	125	140	160
Minimum edge distance	c_{min}	[mm]	40	50	60	70	80	100	125	140	160

¹⁾ both nominal drill hole diameter can be used

Table B3: Installation parameters for Internal threaded anchor rod

Internal threaded anchor rod			IG-M6	IG-M8	IG-M10	IG-M12	IG-M16	IG-M20
Internal diameter of anchor rod	d_2	[mm]	6	8	10	12	16	20
Outer diameter of anchor rod ¹⁾	$d = d_{nom}$	[mm]	10	12	16	20	24	30
Nominal drill hole diameter	d_0	[mm]	12	14	18	22	28	35
Effective embedment depth	$h_{ef,min}$	[mm]	60	70	80	90	96	120
	$h_{ef,max}$	[mm]	200	240	320	400	480	600
Diameter of clearance hole in the fixture	$d_f \leq$	[mm]	7	9	12	14	18	22
Maximum installation torque	$\max T_{inst}$	[Nm]	10	10	20	40	60	100
Thread engagement length min/max	l_{IG}	[mm]	8/20	8/20	10/25	12/30	16/32	20/40
Minimum thickness of member	h_{min}	[mm]	$h_{ef} + 30 \text{ mm}$ $\geq 100 \text{ mm}$			$h_{ef} + 2d_0$		
Minimum spacing	s_{min}	[mm]	50	60	80	100	120	150
Minimum edge distance	c_{min}	[mm]	50	60	80	100	120	150





¹⁾ With metric threads according to EN 1993-1-8:2005+AC:2009

SOUDAFIX VE400-SF, SOUDAFIX VE400-SF ARCTIC

Intended Use
Installation parameters

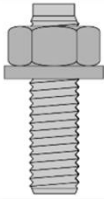
Annex B 3

Table B4: Parameter cleaning and installation tools

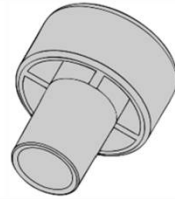
								Installation direction and use of piston plug		
Threaded Rod	Reinforcing bar	Internal threaded anchor rod	d_0 Drill bit - \varnothing HD, HDB, CD	d_b Brush - \varnothing		$d_{b,min}$ min. Brush - \varnothing	Piston plug			
[mm]	[mm]	[mm]	[mm]		[mm]	[mm]		↓	→	↑
M8	8		10	RBT10	12	10,5	No plug required			
M10	8 / 10	IG-M6	12	RBT12	14	12,5				
M12	10 / 12	IG-M8	14	RBT14	16	14,5				
	12		16	RBT16	18	16,5				
M16	14	IG-M10	18	RBT18	20	18,5	VS18	$h_{ef} > 250$ mm	$h_{ef} > 250$ mm	all
	16		20	RBT20	22	20,5	VS20			
M20		IG-M12	24	RBT24	26	24,5	VS24			
	20		25	RBT25	27	25,5	VS25			
M24		IG-M16	28	RBT28	30	28,5	VS28			
M27	25		32	RBT32	34	32,5	VS32			
M30	28	IG-M20	35	RBT35	37	35,5	VS35			
	32		40	RBT40	41,5	40,5	VS40			

Cleaning and installation tools

Hand pump

(Volume 750 ml, $h_0 \leq 10 d_s$, $d_0 \leq 20$ mm)



Compressed air tool

(min 6 bar)



Brush RBT



Piston Plug VS



Brush extension RBL



SOUDAFIX VE400-SF, SOUDAFIX VE400-SF ARCTIC

Intended Use

Cleaning and installation tools

Annex B 4

Table B5: Working time and curing time SOUDAFIX VE400-SF

Temperature in base material			Maximum working time	Minimum curing time ¹⁾
T			t_{gel}	t_{cure}
- 10 °C	to	- 6 °C	90 min ²⁾	24 h
- 5 °C	to	- 1 °C	90 min	14 h
0 °C	to	+ 4 °C	45 min	7 h
+ 5 °C	to	+ 9 °C	25 min	2 h
+ 10 °C	to	+ 19 °C	15 min	80 min
+ 20 °C	to	+ 29 °C	6 min	45 min
+ 30 °C	to	+ 34 °C	4 min	25 min
+ 35 °C	to	+ 39 °C	2 min	20 min
+40°C			1,5 min	15 min
Cartridge temperature			+5°C to +40°C	

1) The minimum curing time is only valid for dry base material.
In wet base material the curing time must be doubled.

2) Cartridge temperature must be at least +15°C

Table B6: Working time and curing time SOUDAFIX VE400-SF ARCTIC

Temperature in base material			Maximum working time	Minimum curing time ¹⁾
T			t_{gel}	t_{cure}
- 20 °C	to	- 16 °C	75 min	24 h
- 15 °C	to	- 11 °C	55 min	16 h
- 10 °C	to	- 6 °C	35 min	10 h
- 5 °C	to	- 1 °C	20 min	5 h
0 °C	to	+ 4 °C	10 min	2,5 h
+ 5 °C	to	+ 9 °C	6 min	80 min
+ 10 °C			6 min	60 min
Cartridge temperature			-20°C to +10°C	

1) The minimum curing time is only valid for dry base material.
In wet base material the curing time must be doubled.

SOUDAFIX VE400-SF, SOUDAFIX VE400-SF ARCTIC

Intended Use
Working time and curing time

Annex B 5

Installation instructions

Drilling of the bore hole

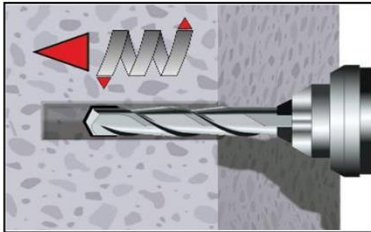

1a. Hammer drilling (HD) / Compressed air drilling (CD)

Drill a hole to the required embedment depth.
Drill bit diameter according to Table B1, B2 or B3.
Aborted drill holes shall be filled with mortar.
Proceed with Step 2 (CAC and MAC).

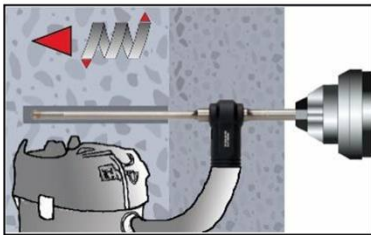

1b. Hollow drill bit system (HDB)

Drill a hole to the required embedment depth.
Drill bit diameter according to Table B1, B2 or B3.
Aborted drill holes shall be filled with mortar.
Proceed with Step 2 (CAC and MAC).

Attention! Standing water in the bore hole must be removed before cleaning

Manual Air Cleaning (MAC)

for bore hole diameter $d_0 \leq 20\text{mm}$ and bore hole depth $h_0 \leq 10d_{\text{nom}}$ ($d_0 < 14\text{mm}$ uncracked concrete only)
with drilling method HD, HDB and CD

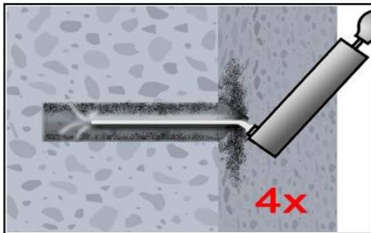

2a. Blow the bore hole clean minimum 4x from the bottom or back by hand pump (Annex B 4).

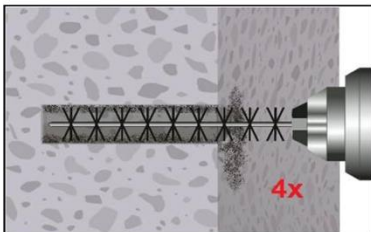

2b. Brush the bore hole minimum 4x with brush RBT according to Table B4 over the entire embedment depth in a twisting motion. (If necessary, a brush extension RBL shall be used.)

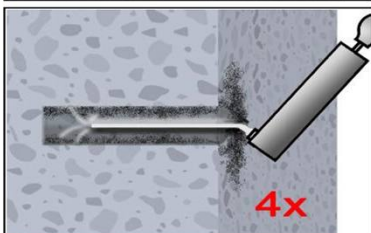

2c. Finally blow the bore hole clean minimum 4x from the bottom or back by hand pump (Annex B 4).

SOUDAFIX VE400-SF, SOUDAFIX VE400-SF ARCTIC

Intended Use
Installation instructions

Annex B 6

Installation instructions (continuation)

Compressed Air Cleaning (CAC):

All diameter with drilling method HD, HDB and CD

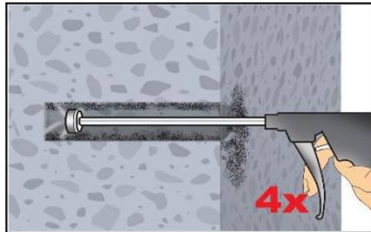

2a. Blow the bore hole clean minimum 4x with compressed air (min. 6 bar) (Annex B 4) over the entire embedment depth until return air stream is free of noticeable dust. (If necessary, an extension shall be used.)

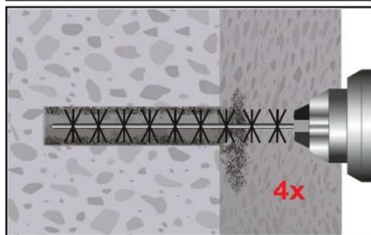

2b. Brush the bore hole minimum 4x with brush RBT according to Table B4 over the entire embedment depth in a twisting motion. (If necessary, a brush extension RBL shall be used.)

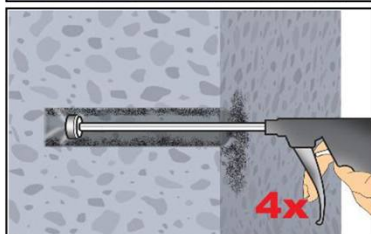

2c. Finally blow the bore hole clean minimum 4x with compressed air (min. 6 bar) (Annex B 4) over the entire embedment depth until return air stream is free of noticeable dust. (If necessary, an extension shall be used.)

Cleaned bore hole has to be protected against re-contamination in an appropriate way, If necessary, repeat cleaning process directly before dispensing the mortar. In-flowing water must not contaminate the bore hole again.

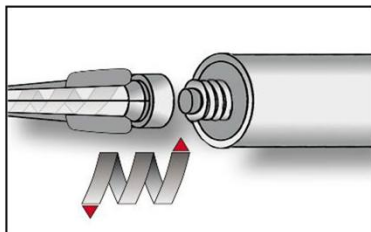

3. Screw on static-mixing nozzle CRW 14W/PM-19E and load the cartridge into an appropriate dispensing tool. With foil tube cartridges cut off the foil tube clip before use. For every working interruption longer than the maximum working time t_{work} (Annex B 5) as well as for new cartridges, a new static-mixer shall be used.

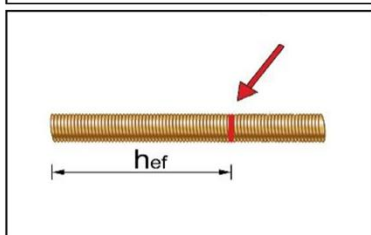

4. Mark embedment depth on the anchor rod. The anchor rod shall be free of dirt, grease, oil or other foreign material.

SOUDAFIX VE400-SF, SOUDAFIX VE400-SF ARCTIC

Intended Use
Installation instructions (continuation)

Annex B 7

Installation instructions (continuation)

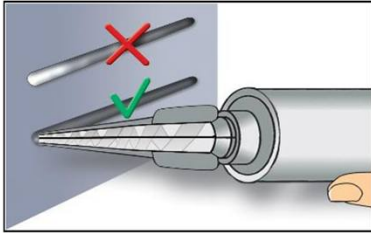

6. Not proper mixed mortar is not sufficient for fastening. Dispense and discard mortar until an uniform grey or red colour is shown (at least 3 full strokes, for foil tube cartridges at least 6 full strokes).

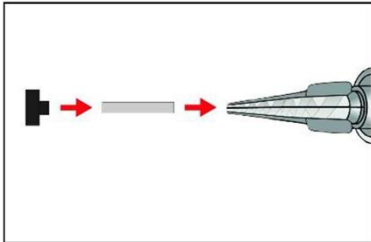

7. Piston plugs VS and mixer nozzle extensions VL shall be used according to Table B4 for the following applications:

- Horizontal and vertical downwards direction: Drill bit- $\varnothing d_0 \geq 18$ mm and embedment depth $h_{ef} > 250$ mm
- Vertical upwards direction: Drill bit- $\varnothing d_0 \geq 18$ mm

Assemble mixing nozzle, mixer extension and piston plug before injecting mortar.

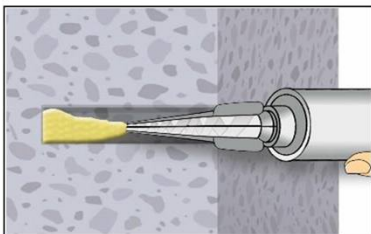

8a. **Injecting mortar without piston plug VS:**
Starting at bottom of the hole and fill the hole up to approximately two-thirds with adhesive. (If necessary, a mixer nozzle extension shall be used.) Slowly withdraw of the static mixing nozzle avoid creating air pockets. Observe the temperature related working time t_{work} (Annex B 5).

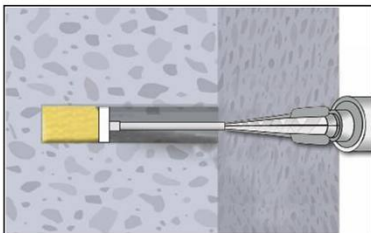

8b. **Injecting mortar with piston plug VS:**
Starting at bottom of the hole and fill the hole up to approximately two-thirds with adhesive. (If necessary, a mixer nozzle extension shall be used.) During injection the piston plug is pushed out of the bore hole by the back pressure of the mortar. Observe the temperature related working time t_{work} (Annex B 5).

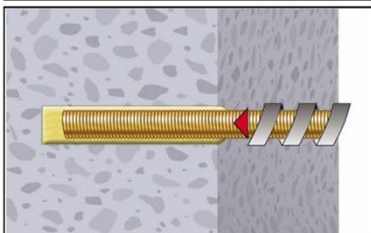

9. Insert the anchor rod while turning slightly up to the embedment mark.

SOUDAFIX VE400-SF, SOUDAFIX VE400-SF ARCTIC

Intended Use
Installation instructions (continuation)

Annex B 8

Installation instructions (continuation)

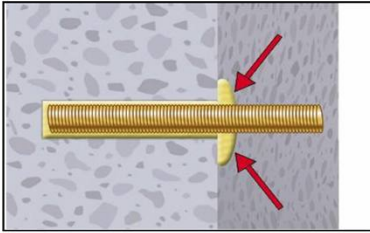

10. Annular gap between anchor rod and base material must be completely filled with mortar. In case of push through installation the annular gap in the fixture must be filled with mortar also. Otherwise, the installation must be repeated starting from step 7 before the maximum working time t_{work} has expired.

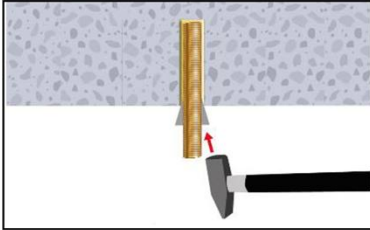

11. For application in vertical upwards direction the anchor rod shall be fixed (e.g. wedges).

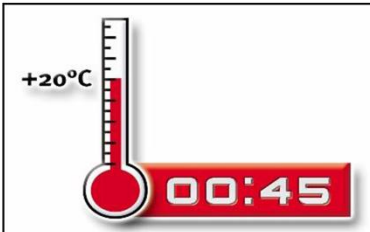

12. Temperature related curing time t_{cure} (Annex B 5) must be observed. Do not move or load the fastener during curing time.

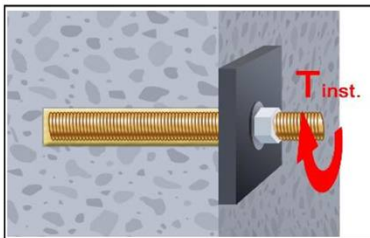

12. Install the fixture by using a calibrated torque wrench. Observe maximum installation torque (Table B1, B2 or B3). In case of static requirements (e.g. seismic), fill the annular gap in the fixture with mortar (Annex A 3). Therefore replace the washer by the filling washer VFS and use the mixer reduction nozzle MR.

SOUDAFIX VE400-SF, SOUDAFIX VE400-SF ARCTIC

Annex B 9

Intended Use
Installation instructions (continuation)

Table C1: Characteristic values for steel tension resistance and steel shear resistance of threaded rods											
Threaded rod			M8	M10	M12	M16	M20	M24	M27	M30	
Cross section area	A_s	[mm ²]	36,6	58	84,3	157	245	353	459	561	
Characteristic tension resistance, Steel failure ¹⁾											
Steel, Property class 4.6 and 4.8	$N_{Rk,s}$	[kN]	15 (13)	23 (21)	34	63	98	141	184	224	
Steel, Property class 5.6 and 5.8	$N_{Rk,s}$	[kN]	18 (17)	29 (27)	42	78	122	176	230	280	
Steel, Property class 8.8	$N_{Rk,s}$	[kN]	29 (27)	46 (43)	67	125	196	282	368	449	
Stainless steel A2, A4 and HCR, class 50	$N_{Rk,s}$	[kN]	18	29	42	79	123	177	230	281	
Stainless steel A2, A4 and HCR, class 70	$N_{Rk,s}$	[kN]	26	41	59	110	171	247	– ³⁾	– ³⁾	
Stainless steel A4 and HCR, class 80	$N_{Rk,s}$	[kN]	29	46	67	126	196	282	– ³⁾	– ³⁾	
Characteristic tension resistance, Partial factor ²⁾											
Steel, Property class 4.6 and 5.6	$\gamma_{Ms,N}$	[-]	2,0								
Steel, Property class 4.8, 5.8 and 8.8	$\gamma_{Ms,N}$	[-]	1,5								
Stainless steel A2, A4 and HCR, class 50	$\gamma_{Ms,N}$	[-]	2,86								
Stainless steel A2, A4 and HCR, class 70	$\gamma_{Ms,N}$	[-]	1,87								
Stainless steel A4 and HCR, class 80	$\gamma_{Ms,N}$	[-]	1,6								
Characteristic shear resistance, Steel failure ¹⁾											
Without lever arm	Steel, Property class 4.6 and 4.8	$V^0_{Rk,s}$	[kN]	9 (8)	14 (13)	20	38	59	85	110	135
	Steel, Property class 5.6 and 5.8	$V^0_{Rk,s}$	[kN]	11 (10)	17 (16)	25	47	74	106	138	168
	Steel, Property class 8.8	$V^0_{Rk,s}$	[kN]	15 (13)	23 (21)	34	63	98	141	184	224
	Stainless steel A2, A4 and HCR, class 50	$V^0_{Rk,s}$	[kN]	9	15	21	39	61	88	115	140
	Stainless steel A2, A4 and HCR, class 70	$V^0_{Rk,s}$	[kN]	13	20	30	55	86	124	– ³⁾	– ³⁾
	Stainless steel A4 and HCR, class 80	$V^0_{Rk,s}$	[kN]	15	23	34	63	98	141	– ³⁾	– ³⁾
With lever arm	Steel, Property class 4.6 and 4.8	$M^0_{Rk,s}$	[Nm]	15 (13)	30 (27)	52	133	260	449	666	900
	Steel, Property class 5.6 and 5.8	$M^0_{Rk,s}$	[Nm]	19 (16)	37 (33)	65	166	324	560	833	1123
	Steel, Property class 8.8	$M^0_{Rk,s}$	[Nm]	30 (26)	60 (53)	105	266	519	896	1333	1797
	Stainless steel A2, A4 and HCR, class 50	$M^0_{Rk,s}$	[Nm]	19	37	66	167	325	561	832	1125
	Stainless steel A2, A4 and HCR, class 70	$M^0_{Rk,s}$	[Nm]	26	52	92	232	454	784	– ³⁾	– ³⁾
	Stainless steel A4 and HCR, class 80	$M^0_{Rk,s}$	[Nm]	30	59	105	266	519	896	– ³⁾	– ³⁾
Characteristic shear resistance, Partial factor ²⁾											
Steel, Property class 4.6 and 5.6	$\gamma_{Ms,V}$	[-]	1,67								
Steel, Property class 4.8, 5.8 and 8.8	$\gamma_{Ms,V}$	[-]	1,25								
Stainless steel A2, A4 and HCR, class 50	$\gamma_{Ms,V}$	[-]	2,38								
Stainless steel A2, A4 and HCR, class 70	$\gamma_{Ms,V}$	[-]	1,56								
Stainless steel A4 and HCR, class 80	$\gamma_{Ms,V}$	[-]	1,33								
¹⁾ Values are only valid for the given stress area A_s . Values in brackets are valid for undersized threaded rods with smaller stress area A_s for hot-dip galvanised threaded rods according to EN ISO 10684:2004+AC:2009. ²⁾ in absence of national regulation ³⁾ Fastener type not part of the ETA											
SOUDAFIX VE400-SF, SOUDAFIX VE400-SF ARCTIC									Annex C 1		
Performances Characteristic values for steel tension resistance and steel shear resistance of threaded rods											

Table C2: Characteristic values of tension loads under static and quasi-static action				
Fastener			All Anchor types and sizes	
Concrete cone failure				
Uncracked concrete	$k_{ucr,N}$	[-]	11,0	
Cracked concrete	$k_{cr,N}$	[-]	7,7	
Edge distance	$c_{cr,N}$	[mm]	1,5 h_{ef}	
Axial distance	$s_{cr,N}$	[mm]	2 $c_{cr,N}$	
Splitting				
Edge distance	$h/h_{ef} \geq 2,0$	$c_{cr,sp}$	[mm]	1,0 h_{ef}
	$2,0 > h/h_{ef} > 1,3$			$2 \cdot h_{ef} \left(2,5 - \frac{h}{h_{ef}} \right)$
	$h/h_{ef} \leq 1,3$			2,4 h_{ef}
Axial distance	$s_{cr,sp}$	[mm]	2 $c_{cr,sp}$	
SOUDAFIX VE400-SF, SOUDAFIX VE400-SF ARCTIC				Annex C 2
Performances Characteristic values for Concrete cone failure and Splitting with all kind of action				

Table C3: Characteristic values of tension loads under static and quasi-static action													
Threaded rod				M8	M10	M12	M16	M20	M24	M27	M30		
Steel failure													
Characteristic tension resistance		$N_{Rk,s}$	[kN]	$A_s \cdot f_{uk}$ (or see Table C1)									
Partial factor		$\gamma_{Ms,N}$	[-]	see Table C1									
Combined pull-out and concrete failure													
Characteristic bond resistance in uncracked concrete C20/25													
Temperature range	I: 40°C/24°C	Dry, wet concrete	$\tau_{Rk,ucr}$	[N/mm ²]	10	12	12	12	12	11	10	9,0	
	II: 80°C/50°C				7,5	9,0	9,0	9,0	9,0	8,5	7,5	6,5	
	III: 120°C/72°C				5,5	6,5	6,5	6,5	6,5	6,5	5,5	5,0	
	I: 40°C/24°C	flooded bore hole			7,5	8,5	8,5	8,5	No Performance Assessed				
	II: 80°C/50°C				5,5	6,5	6,5	6,5					
	III: 120°C/72°C				4,0	5,0	5,0	5,0					
Characteristic bond resistance in cracked concrete C20/25													
Temperature range	I: 40°C/24°C	Dry, wet concrete	$\tau_{Rk,cr}$	[N/mm ²]	4,0	5,0	5,5	5,5	5,5	5,5	6,5	6,5	
	II: 80°C/50°C				2,5	3,5	4,0	4,0	4,0	4,0	4,5	4,5	
	III: 120°C/72°C				2,0	2,5	3,0	3,0	3,0	3,0	3,5	3,5	
	I: 40°C/24°C	flooded bore hole			4,0	4,0	5,5	5,5	No Performance Assessed				
	II: 80°C/50°C				2,5	3,0	4,0	4,0					
	III: 120°C/72°C				2,0	2,5	3,0	3,0					
Reduktion factor ψ_{sus}^0 in cracked and uncracked concrete C20/25													
Temperature range	I: 40°C/24°C	Dry, wet concrete and flooded bore hole	ψ_{sus}^0	[-]	0,73								
	II: 80°C/50°C				0,65								
	III: 120°C/72°C				0,57								
Increasing factors for concrete		ψ_c	[-]	$(f_{ck} / 20)^{0,11}$									
Characteristic bond resistance depending on the concrete strength class		$\tau_{Rk,ucr} =$		$\psi_c \cdot \tau_{Rk,ucr}(C20/25)$									
		$\tau_{Rk,cr} =$		$\psi_c \cdot \tau_{Rk,cr}(C20/25)$									
Concrete cone failure													
Relevant parameter				see Table C2									
Splitting													
Relevant parameter				see Table C2									
Installation factor													
for dry and wet concrete		γ_{inst}	[-]	1,0	1,2								
for flooded bore hole				1,4	No Performance Assessed								
SOUDAFIX VE400-SF, SOUDAFIX VE400-SF ARCTIC										Annex C 3			
Performances Characteristic values of tension loads under static and quasi-static action (Threaded rod)													

Table C4: Characteristic values of shear loads under static and quasi-static action											
Threaded rod			M8	M10	M12	M16	M20	M24	M27	M30	
Steel failure without lever arm											
Characteristic shear resistance Steel, strength class 4.6, 4.8, 5.6 and 5.8	$V_{Rk,s}^0$	[kN]	$0,6 \cdot A_s \cdot f_{uk}$ (or see Table C1)								
Characteristic shear resistance Steel, strength class 8.8 Stainless Steel A2, A4 and HCR, all classes	$V_{Rk,s}^0$	[kN]	$0,5 \cdot A_s \cdot f_{uk}$ (or see Table C1)								
Partial factor	$\gamma_{Ms,V}$	[-]	see Table C1								
Ductility factor	k_7	[-]	1,0								
Steel failure with lever arm											
Characteristic bending moment	$M_{Rk,s}^0$	[Nm]	$1,2 \cdot W_{el} \cdot f_{uk}$ (or see Table C1)								
Elastic section modulus	W_{el}	[mm ³]	31	62	109	277	541	935	1387	1874	
Partial factor	$\gamma_{Ms,V}$	[-]	see Table C1								
Concrete pry-out failure											
Factor	k_8	[-]	2,0								
Installation factor	γ_{inst}	[-]	1,0								
Concrete edge failure											
Effective length of fastener	l_f	[mm]	$\min(h_{ef}; 12 \cdot d_{nom})$						$\min(h_{ef}; 300\text{mm})$		
Outside diameter of fastener	d_{nom}	[mm]	8	10	12	16	20	24	27	30	
Installation factor	γ_{inst}	[-]	1,0								
SOUDAFIX VE400-SF, SOUDAFIX VE400-SF ARCTIC									Annex C 4		
Performances Characteristic values of shear loads under static and quasi-static action (Threaded rod)											

Table C5: Characteristic values of tension loads under static and quasi-static action											
Internal threaded anchor rods				IG-M6	IG-M8	IG-M10	IG-M12	IG-M16	IG-M20		
Steel failure¹⁾											
Characteristic tension resistance,	5.8	$N_{Rk,s}$	[kN]	10	17	29	42	76	123		
Steel, strength class	8.8	$N_{Rk,s}$	[kN]	16	27	46	67	121	196		
Partial factor, strength class 5.8 and 8.8		$\gamma_{Ms,N}$	[-]	1,5							
Characteristic tension resistance, Stainless Steel A4 and HCR, Strength class 70 ²⁾		$N_{Rk,s}$	[kN]	14	26	41	59	110	124		
Partial factor		$\gamma_{Ms,N}$	[-]	1,87					2,86		
Combined pull-out and concrete cone failure											
Characteristic bond resistance in uncracked concrete C20/25											
Temperature range	I: 40°C/24°C	Dry, wet concrete	$\tau_{Rk,ucr}$	[N/mm ²]	12	12	12	12	11	9,0	
	II: 80°C/50°C				9,0	9,0	9,0	9,0	8,5	6,5	
	III: 120°C/72°C				6,5	6,5	6,5	6,5	6,5	5,0	
	I: 40°C/24°C	flooded bore hole			8,5	8,5	8,5	No Performance Assessed			
	II: 80°C/50°C				6,5	6,5	6,5				
	III: 120°C/72°C				5,0	5,0	5,0				
Characteristic bond resistance in cracked concrete C20/25											
Temperature range	I: 40°C/24°C	Dry, wet concrete	$\tau_{Rk,cr}$	[N/mm ²]	5,0	5,5	5,5	5,5	5,5	6,5	
	II: 80°C/50°C				3,5	4,0	4,0	4,0	4,0	4,5	
	III: 120°C/72°C				2,5	3,0	3,0	3,0	3,0	3,5	
	I: 40°C/24°C	flooded bore hole			4,0	5,5	5,5	No Performance Assessed			
	II: 80°C/50°C				3,0	4,0	4,0				
	III: 120°C/72°C				2,5	3,0	3,0				
Reduktion factor ψ_{sus}^0 in cracked and uncracked concrete C20/25											
Temperature range	I: 40°C/24°C	Dry, wet concrete and flooded bore hole	ψ_{sus}^0	[-]	0,73						
	II: 80°C/50°C				0,65						
	III: 120°C/72°C				0,57						
Increasing factors for concrete			ψ_c	[-]	$(f_{ck} / 20)^{0,11}$						
Characteristic bond resistance depending on the concrete strength class			$\tau_{Rk,ucr} =$		$\psi_c \cdot \tau_{Rk,ucr}(C20/25)$						
			$\tau_{Rk,cr} =$		$\psi_c \cdot \tau_{Rk,cr}(C20/25)$						
Concrete cone failure											
Relevant parameter				see Table C2							
Splitting failure											
Relevant parameter				see Table C2							
Installation factor											
for dry and wet concrete			γ_{inst}	[-]	1,2						
for flooded bore hole					1,4	No Performance Assessed					
<p>1) Fastenings (incl. nut and washer) must comply with the appropriate material and property class of the internal threaded rod. The characteristic tension resistance for steel failure is valid for the internal threaded rod and the fastening element.</p> <p>2) For IG-M20 strength class 50 is valid</p>											
SOUDAFIX VE400-SF, SOUDAFIX VE400-SF ARCTIC								Annex C 5			
Performances Characteristic values of tension loads under static and quasi-static action (Internal threaded anchor rod)											

Table C6: Characteristic values of shear loads under static and quasi-static action									
Internal threaded anchor rods				IG-M6	IG-M8	IG-M10	IG-M12	IG-M16	IG-M20
Steel failure without lever arm¹⁾									
Characteristic shear resistance, Steel, strength class	5.8	$V_{Rk,s}^0$	[kN]	5	9	15	21	38	61
	8.8	$V_{Rk,s}^0$	[kN]	8	14	23	34	60	98
Partial factor, strength class 5.8 and 8.8	$\gamma_{Ms,V}$		[-]	1,25					
Characteristic shear resistance, Stainless Steel A4 and HCR, Strength class 70 ²⁾		$V_{Rk,s}^0$	[kN]	7	13	20	30	55	40
	Partial factor	$\gamma_{Ms,V}$	[-]	1,56					2,38
Ductility factor	k_7		[-]	1,0					
Steel failure with lever arm¹⁾									
Characteristic bending moment, Steel, strength class	5.8	$M_{Rk,s}^0$	[Nm]	8	19	37	66	167	325
	8.8	$M_{Rk,s}^0$	[Nm]	12	30	60	105	267	519
Partial factor, strength class 5.8 and 8.8	$\gamma_{Ms,V}$		[-]	1,25					
Characteristic bending moment, Stainless Steel A4 and HCR, Strength class 70 ²⁾		$M_{Rk,s}^0$	[Nm]	11	26	52	92	233	456
	Partial factor	$\gamma_{Ms,V}$	[-]	1,56					2,38
Concrete pry-out failure									
Factor	k_8		[-]	2,0					
Installation factor	γ_{inst}		[-]	1,0					
Concrete edge failure									
Effective length of fastener	l_f		[mm]	$\min(h_{ef}; 12 \cdot d_{nom})$					$\min(h_{ef}; 300\text{mm})$
Outside diameter of fastener	d_{nom}		[mm]	10	12	16	20	24	30
Installation factor	γ_{inst}		[-]	1,0					
<p>¹⁾ Fastenings (incl. nut and washer) must comply with the appropriate material and property class of the internal threaded rod. The characteristic tension resistance for steel failure is valid for the internal threaded rod and the fastening element.</p> <p>²⁾ For IG-M20 strength class 50 is valid</p>									
SOUDAFIX VE400-SF, SOUDAFIX VE400-SF ARCTIC								Annex C 6	
Performances Characteristic values of shear loads under static and quasi-static action (Internal threaded anchor rod)									

Table C7: Characteristic values of tension loads under static and quasi-static action														
Reinforcing bar			Ø 8	Ø 10	Ø 12	Ø 14	Ø 16	Ø 20	Ø 25	Ø 28	Ø 32			
Steel failure														
Characteristic tension resistance	$N_{Rk,s}$	[kN]	$A_s \cdot f_{uk}^{1)}$											
Cross section area	A_s	[mm ²]	50	79	113	154	201	314	491	616	804			
Partial factor	$\gamma_{Ms,N}$	[-]	1,4 ²⁾											
Combined pull-out and concrete failure														
Characteristic bond resistance in uncracked concrete C20/25														
Temperature range	I: 40°C/24°C	Dry, wet concrete	$\tau_{Rk,ucr}$	[N/mm ²]	10	12	12	12	12	12	11	10	8,5	
	II: 80°C/50°C				7,5	9,0	9,0	9,0	9,0	9,0	8,0	7,0	6,0	
	III: 120°C/72°C				5,5	6,5	6,5	6,5	6,5	6,5	6,0	5,0	4,5	
	I: 40°C/24°C	flooded bore hole			7,5	8,5	8,5	8,5	8,5	No Performance Assessed				
	II: 80°C/50°C				5,5	6,5	6,5	6,5	6,5					
	III: 120°C/72°C				4,0	5,0	5,0	5,0	5,0					
Characteristic bond resistance in cracked concrete C20/25														
Temperature range	I: 40°C/24°C	Dry, wet concrete	$\tau_{Rk,cr}$	[N/mm ²]	4,0	5,0	5,5	5,5	5,5	5,5	5,5	6,5	6,5	
	II: 80°C/50°C				2,5	3,5	4,0	4,0	4,0	4,0	4,0	4,5	4,5	
	III: 120°C/72°C				2,0	2,5	3,0	3,0	3,0	3,0	3,0	3,5	3,5	
	I: 40°C/24°C	flooded bore hole			4,0	4,0	5,5	5,5	5,5	No Performance Assessed				
	II: 80°C/50°C				2,5	3,0	4,0	4,0	4,0					
	III: 120°C/72°C				2,0	2,5	3,0	3,0	3,0					
Reduktion factor ψ_{sus}^0 in cracked and uncracked concrete C20/25														
Temperature range	I: 40°C/24°C	Dry, wet concrete and flooded bore hole	ψ_{sus}^0	[-]	0,73									
	II: 80°C/50°C				0,65									
	III: 120°C/72°C				0,57									
Increasing factors for concrete		ψ_c	[-]	$(f_{ck} / 20)^{0,11}$										
Characteristic bond resistance depending on the concrete strength class		$\tau_{Rk,ucr} =$		$\psi_c \cdot \tau_{Rk,ucr}(C20/25)$										
		$\tau_{Rk,cr} =$		$\psi_c \cdot \tau_{Rk,cr}(C20/25)$										
Concrete cone failure														
Relevant parameter		see Table C2												
Splitting														
Relevant parameter		see Table C2												
Installation factor														
for dry and wet concrete		γ_{inst}	[-]	1,0	1,2									
for flooded bore hole				1,4	No Performance Assessed									
¹⁾ f_{uk} shall be taken from the specifications of reinforcing bars ²⁾ in absence of national regulation														
SOUDAFIX VE400-SF, SOUDAFIX VE400-SF ARCTIC											Annex C 7			
Performances Characteristic values of tension loads under static and quasi-static action (Reinforcing bar)														

Table C8: Characteristic values of shear loads under static and quasi-static action											
Reinforcing bar			Ø 8	Ø 10	Ø 12	Ø 14	Ø 16	Ø 20	Ø 25	Ø 28	Ø 32
Steel failure without lever arm											
Characteristic shear resistance	$V_{Rk,s}^0$	[kN]	$0,50 \cdot A_s \cdot f_{uk}^{1)}$								
Cross section area	A_s	[mm ²]	50	79	113	154	201	314	491	616	804
Partial factor	$\gamma_{Ms,V}$	[-]	1,5 ²⁾								
Ductility factor	k_7	[-]	1,0								
Steel failure with lever arm											
Characteristic bending moment	$M_{Rk,s}^0$	[Nm]	$1,2 \cdot W_{el} \cdot f_{uk}^{1)}$								
Elastic section modulus	W_{el}	[mm ³]	50	98	170	269	402	785	1534	2155	3217
Partial factor	$\gamma_{Ms,V}$	[-]	1,5 ²⁾								
Concrete pry-out failure											
Factor	k_8	[-]	2,0								
Installation factor	γ_{inst}	[-]	1,0								
Concrete edge failure											
Effective length of fastener	l_f	[mm]	$\min(h_{ef}; 12 \cdot d_{nom})$						$\min(h_{ef}; 300\text{mm})$		
Outside diameter of fastener	d_{nom}	[mm]	8	10	12	14	16	20	25	28	32
Installation factor	γ_{inst}	[-]	1,0								
<p>¹⁾ f_{uk} shall be taken from the specifications of reinforcing bars</p> <p>²⁾ in absence of national regulation</p>											
SOUDAFIX VE400-SF, SOUDAFIX VE400-SF ARCTIC										Annex C 8	
Performances Characteristic values of shear loads under static and quasi-static action (Reinforcing bar)											

Table C9: Displacements under tension load¹⁾										
Threaded rod			M8	M10	M12	M16	M20	M24	M27	M30
Uncracked concrete C20/25 under static and quasi-static action										
Temperature range I: 40°C/24°C	δ_{N0} -factor	[mm/(N/mm ²)]	0,021	0,023	0,026	0,031	0,036	0,041	0,045	0,049
	$\delta_{N\infty}$ -factor	[mm/(N/mm ²)]	0,030	0,033	0,037	0,045	0,052	0,060	0,065	0,071
Temperature range II: 80°C/50°C	δ_{N0} -factor	[mm/(N/mm ²)]	0,050	0,056	0,063	0,075	0,088	0,100	0,110	0,119
	$\delta_{N\infty}$ -factor	[mm/(N/mm ²)]	0,072	0,081	0,090	0,108	0,127	0,145	0,159	0,172
Temperature range III: 120°C/72°C	δ_{N0} -factor	[mm/(N/mm ²)]	0,050	0,056	0,063	0,075	0,088	0,100	0,110	0,119
	$\delta_{N\infty}$ -factor	[mm/(N/mm ²)]	0,072	0,081	0,090	0,108	0,127	0,145	0,159	0,172
Cracked concrete C20/25 under static and quasi-static action										
Temperature range I: 40°C/24°C	δ_{N0} -factor	[mm/(N/mm ²)]	0,090		0,070					
	$\delta_{N\infty}$ -factor	[mm/(N/mm ²)]	0,105		0,105					
Temperature range II: 80°C/50°C	δ_{N0} -factor	[mm/(N/mm ²)]	0,219		0,170					
	$\delta_{N\infty}$ -factor	[mm/(N/mm ²)]	0,255		0,245					
Temperature range III: 120°C/72°C	δ_{N0} -factor	[mm/(N/mm ²)]	0,219		0,170					
	$\delta_{N\infty}$ -factor	[mm/(N/mm ²)]	0,255		0,245					
¹⁾ Calculation of the displacement $\delta_{N0} = \delta_{N0}\text{-factor} \cdot \tau;$ τ : action bond stress for tension $\delta_{N\infty} = \delta_{N\infty}\text{-factor} \cdot \tau;$										
Table C10: Displacements under shear load¹⁾										
Threaded rod			M8	M10	M12	M16	M20	M24	M27	M30
Uncracked concrete C20/25 under static and quasi-static action										
All temperature ranges	δ_{V0} -factor	[mm/kN]	0,06	0,06	0,05	0,04	0,04	0,03	0,03	0,03
	$\delta_{V\infty}$ -factor	[mm/kN]	0,09	0,08	0,08	0,06	0,06	0,05	0,05	0,05
Cracked concrete C20/25 under static and quasi-static action										
All temperature ranges	δ_{V0} -factor	[mm/kN]	0,12	0,12	0,11	0,10	0,09	0,08	0,08	0,07
	$\delta_{V\infty}$ -factor	[mm/kN]	0,18	0,18	0,17	0,15	0,14	0,13	0,12	0,10
¹⁾ Calculation of the displacement $\delta_{V0} = \delta_{V0}\text{-factor} \cdot V;$ V : action shear load $\delta_{V\infty} = \delta_{V\infty}\text{-factor} \cdot V;$										
SOUDAFIX VE400-SF, SOUDAFIX VE400-SF ARCTIC									Annex C 9	
Performances Displacements under static and quasi-static action (threaded rods)										

Table C11: Displacements under tension load¹⁾								
Internal threaded anchor rod			IG-M6	IG-M8	IG-M10	IG-M12	IG-M16	IG-M20
Uncracked concrete C20/25 under static and quasi-static action								
Temperature range I: 40°C/24°C	δ_{N0} -factor	[mm/(N/mm ²)]	0,023	0,026	0,031	0,036	0,041	0,049
	$\delta_{N\infty}$ -factor	[mm/(N/mm ²)]	0,033	0,037	0,045	0,052	0,060	0,071
Temperature range II: 80°C/50°C	δ_{N0} -factor	[mm/(N/mm ²)]	0,056	0,063	0,075	0,088	0,100	0,119
	$\delta_{N\infty}$ -factor	[mm/(N/mm ²)]	0,081	0,090	0,108	0,127	0,145	0,172
Temperature range III: 120°C/72°C	δ_{N0} -factor	[mm/(N/mm ²)]	0,056	0,063	0,075	0,088	0,100	0,119
	$\delta_{N\infty}$ -factor	[mm/(N/mm ²)]	0,081	0,090	0,108	0,127	0,145	0,172
Cracked concrete C20/25 under static and quasi-static action								
Temperature range I: 40°C/24°C	δ_{N0} -factor	[mm/(N/mm ²)]	0,090	0,070				
	$\delta_{N\infty}$ -factor	[mm/(N/mm ²)]	0,105	0,105				
Temperature range II: 80°C/50°C	δ_{N0} -factor	[mm/(N/mm ²)]	0,219	0,170				
	$\delta_{N\infty}$ -factor	[mm/(N/mm ²)]	0,255	0,245				
Temperature range III: 120°C/72°C	δ_{N0} -factor	[mm/(N/mm ²)]	0,219	0,170				
	$\delta_{N\infty}$ -factor	[mm/(N/mm ²)]	0,255	0,245				
¹⁾ Calculation of the displacement $\delta_{N0} = \delta_{N0}\text{-factor} \cdot \tau;$ τ : action bond stress for tension $\delta_{N\infty} = \delta_{N\infty}\text{-factor} \cdot \tau;$								
Table C12: Displacements under shear load¹⁾								
Internal threaded anchor rod			IG-M6	IG-M8	IG-M10	IG-M12	IG-M16	IG-M20
Uncracked and cracked concrete C20/25 under static and quasi-static action								
All temperature ranges	δ_{V0} -factor	[mm/kN]	0,07	0,06	0,06	0,05	0,04	0,04
	$\delta_{V\infty}$ -factor	[mm/kN]	0,10	0,09	0,08	0,08	0,06	0,06
¹⁾ Calculation of the displacement $\delta_{V0} = \delta_{V0}\text{-factor} \cdot V;$ V : action shear load $\delta_{V\infty} = \delta_{V\infty}\text{-factor} \cdot V;$								
SOUDAFIX VE400-SF, SOUDAFIX VE400-SF ARCTIC							Annex C 10	
Performances Displacements under static and quasi-static action (Internal threaded anchor rod)								

Table C13: Displacements under tension load¹⁾ (rebar)											
Anchor size reinforcing bar		Ø 8	Ø 10	Ø 12	Ø 14	Ø 16	Ø 20	Ø 25	Ø 28	Ø 32	
Uncracked concrete C20/25 under static and quasi-static action											
Temperature range I: 40°C/24°C	δ _{N0} -factor	[mm/(N/mm ²)]	0,021	0,023	0,026	0,028	0,031	0,036	0,043	0,047	0,052
	δ _{N∞} -factor	[mm/(N/mm ²)]	0,030	0,033	0,037	0,041	0,045	0,052	0,061	0,071	0,075
Temperature range II: 80°C/50°C	δ _{N0} -factor	[mm/(N/mm ²)]	0,050	0,056	0,063	0,069	0,075	0,088	0,104	0,113	0,126
	δ _{N∞} -factor	[mm/(N/mm ²)]	0,072	0,081	0,090	0,099	0,108	0,127	0,149	0,163	0,181
Temperature range III: 120°C/72°C	δ _{N0} -factor	[mm/(N/mm ²)]	0,050	0,056	0,063	0,069	0,075	0,088	0,104	0,113	0,126
	δ _{N∞} -factor	[mm/(N/mm ²)]	0,072	0,081	0,090	0,099	0,108	0,127	0,149	0,163	0,181
Cracked concrete C20/25 under static and quasi-static action											
Temperature range I: 40°C/24°C	δ _{N0} -factor	[mm/(N/mm ²)]	0,090			0,070					
	δ _{N∞} -factor	[mm/(N/mm ²)]	0,105			0,105					
Temperature range II: 80°C/50°C	δ _{N0} -factor	[mm/(N/mm ²)]	0,219			0,170					
	δ _{N∞} -factor	[mm/(N/mm ²)]	0,255			0,245					
Temperature range III: 120°C/72°C	δ _{N0} -factor	[mm/(N/mm ²)]	0,219			0,170					
	δ _{N∞} -factor	[mm/(N/mm ²)]	0,255			0,245					
¹⁾ Calculation of the displacement $\delta_{N0} = \delta_{N0\text{-factor}} \cdot \tau;$ τ : action bond stress for tension $\delta_{N\infty} = \delta_{N\infty\text{-factor}} \cdot \tau;$											
Table C14: Displacement under shear load¹⁾ (rebar)											
Anchor size reinforcing bar		Ø 8	Ø 10	Ø 12	Ø 14	Ø 16	Ø 20	Ø 25	Ø 28	Ø 32	
Uncracked concrete C20/25 under static and quasi-static action											
All temperature ranges	δ _{v0} -factor	[mm/kN]	0,06	0,05	0,05	0,04	0,04	0,04	0,03	0,03	0,03
	δ _{v∞} -factor	[mm/kN]	0,09	0,08	0,08	0,06	0,06	0,05	0,05	0,04	0,04
Cracked concrete C20/25 under static and quasi-static action											
All temperature ranges	δ _{v0} -factor	[mm/kN]	0,12	0,12	0,11	0,11	0,10	0,09	0,08	0,07	0,06
	δ _{v∞} -factor	[mm/kN]	0,18	0,18	0,17	0,16	0,15	0,14	0,12	0,11	0,10
¹⁾ Calculation of the displacement $\delta_{v0} = \delta_{v0\text{-factor}} \cdot V;$ V : action shear load $\delta_{v\infty} = \delta_{v\infty\text{-factor}} \cdot V;$											
SOUDAFIX VE400-SF, SOUDAFIX VE400-SF ARCTIC										Annex C 11	
Performances Displacements under static and quasi-static action (Reinforcing bar)											

Table C15: Characteristic values of tension loads under seismic action (performance category C1)													
Threaded rod			M8	M10	M12	M16	M20	M24	M27	M30			
Steel failure													
Characteristic tension resistance			$N_{Rk,s,eq,C1}$	[kN]	$1,0 \cdot N_{Rk,s}$								
Partial factor			$\gamma_{Ms,N}$	[-]	see Table C1								
Combined pull-out and concrete failure													
Characteristic bond resistance in uncracked and cracked concrete C20/25													
Temperature range	I: 40°C/24°C	Dry, wet concrete	$\tau_{Rk,eq,C1}$	[N/mm ²]	2,5	3,1	3,7	3,7	3,7	3,8	4,5	4,5	
	II: 80°C/50°C				1,6	2,2	2,7	2,7	2,7	2,8	3,1	3,1	
	III: 120°C/72°C				1,3	1,6	2,0	2,0	2,0	2,1	2,4	2,4	
	I: 40°C/24°C	flooded bore hole			2,5	2,5	3,7	3,7	No Performance Assessed				
	II: 80°C/50°C				1,6	1,9	2,7	2,7					
	III: 120°C/72°C				1,3	1,6	2,0	2,0					
Increasing factors for concrete			ψ_c	[-]	1,0								
Characteristic bond resistance depending on the concrete strength class			$\tau_{Rk,eq,C1} =$		$\psi_c \cdot \tau_{Rk,eq,C1}(C20/25)$								
Installation factor													
for dry and wet concrete			γ_{inst}	[-]	1,0	1,2							
for flooded bore hole					1,4				No Performance Assessed				
Table C16: Characteristic values of shear loads under seismic action (performance category C1)													
Threaded rod			M8	M10	M12	M16	M20	M24	M27	M30			
Steel failure without lever arm													
Characteristic shear resistance (Seismic C1)			$V_{Rk,s,eq,C1}$	[kN]	$0,70 \cdot V^0_{Rk,s}$								
Partial factor			$\gamma_{Ms,V}$	[-]	see Table C1								
Factor for annular gap			α_{gap}	[-]	$0,5 (1,0)^{1)}$								
¹⁾ Value in brackets valid for filled annular gap between fastener and clearance hole in the fixture. Use of special filling washer Annex A 3 is recommended													
SOUDAFIX VE400-SF, SOUDAFIX VE400-SF ARCTIC										Annex C 12			
Performances Characteristic values of tension loads and shear loads under seismic action (performance category C1) (Threaded rod)													

Table C17: Characteristic values of tension loads under seismic action (performance category C1)														
Reinforcing bar			Ø 8	Ø 10	Ø 12	Ø 14	Ø 16	Ø 20	Ø 25	Ø 28	Ø 32			
Steel failure														
Characteristic tension resistance		$N_{Rk,s,eq,C1}$	[kN]	$1,0 \cdot A_s \cdot f_{uk}^{1)}$										
Cross section area		A_s	[mm ²]	50	79	113	154	201	314	491	616	804		
Partial factor		$\gamma_{Ms,N}$	[-]	1,4 ²⁾										
Combined pull-out and concrete failure														
Characteristic bond resistance in uncracked and cracked concrete C20/25														
Temperature range	I: 40°C/24°C	Dry, wet concrete	$\tau_{Rk,eq,C1}$	[N/mm ²]	2,5	3,1	3,7	3,7	3,7	3,7	3,8	4,5	4,5	No Performance Assessed
	II: 80°C/50°C				1,6	2,2	2,7	2,7	2,7	2,7	2,8	3,1	3,1	
	III: 120°C/72°C				1,3	1,6	2,0	2,0	2,0	2,0	2,1	2,4	2,4	
	I: 40°C/24°C	flooded bore hole			2,5	2,5	3,7	3,7	3,7					
	II: 80°C/50°C				1,6	1,9	2,7	2,7	2,7					
	III: 120°C/72°C				1,3	1,6	2,0	2,0	2,0					
Increasing factors for concrete		ψ_c	[-]	1,0										
Characteristic bond resistance depending on the concrete strength class		$\tau_{Rk,eq,C1} =$		$\psi_c \cdot \tau_{Rk,eq,C1}(C20/25)$										
Installation factor														
for dry and wet concrete		γ_{inst}	[-]	1,2									1,2	No Performance Assessed
for flooded bore hole				1,4										
¹⁾ f_{uk} shall be taken from the specifications of reinforcing bars ²⁾ in absence of national regulation														
Table C18: Characteristic values of shear loads under seismic action (performance category C1)														
Reinforcing bar			Ø 8	Ø 10	Ø 12	Ø 14	Ø 16	Ø 20	Ø 25	Ø 28	Ø 32			
Steel failure without lever arm														
Characteristic shear resistance		$V_{Rk,s,eq,C1}$	[kN]	$0,35 \cdot A_s \cdot f_{uk}^{2)}$										
Cross section area		A_s	[mm ²]	50	79	113	154	201	314	491	616	804		
Partial factor		$\gamma_{Ms,V}$	[-]	1,5 ²⁾										
Factor for annular gap		α_{gap}	[-]	0,5 (1,0) ³⁾										
¹⁾ f_{uk} shall be taken from the specifications of reinforcing bars ²⁾ in absence of national regulation ³⁾ Value in brackets valid for filled annular gap between fastener and clearance hole in the fixture. Use of special filling washer Annex A 3 is recommended														
SOUDAFIX VE400-SF, SOUDAFIX VE400-SF ARCTIC											Annex C 13			
Performances Characteristic values of tension loads and shear loads under seismic action (performance category C1) (Reinforcing bar)														