

TECHNICAL DATASHEET



REDUCER

01 Update -12/2018

TECHNICAL DATA

Article No	001 115 0080 0112
d1 (mm)	110
d2 (mm)	75
Z (mm)	216
le1 (mm)	82
le2 (mm)	70
s1 (mm)	6.6
s2 (mm)	4.5
Weight (Kg)	0.46
Box Quantity (pcs)	30
Box Dimension (pcs)	36x60x47

INJECTION MOULDED

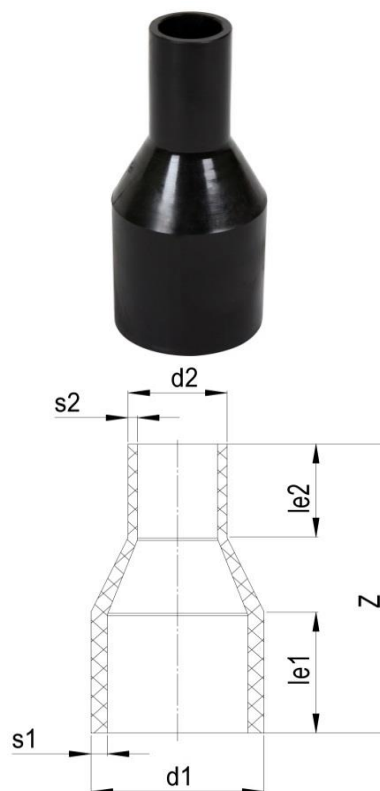

IDENTIFICATION OF PRODUCT

D(mm)	110-75
SDR	17
RAW METARIAL	PE 100
PRESSURE CLASS	10 Bar Water 5 Bar Gas
TRADEMARK	NTG
EXECUTION	Injection Moulded
STANDARD	EN 12201-3 EN 1555-3 AS /NZS 4129

SPECIFICATION

Long Spigot

Tolerance on diameters and thickness according to the standards. The other dimensions are specialized. Tolerance $\pm 5\%$. NTG PLASTIK reserves all the right to change any information without giving prior notice. The production, distribution and utilization of this document without explicit authorization is prohibited.

Fr 161 Rev 00