

TECHNICAL DATASHEET



REDUCER

01 Update -12/2018

TECHNICAL DATA

Article No	001 115 0080 0252
d1 (mm)	250
d2 (mm)	200
Z (mm)	305
le1 (mm)	129
le2 (mm)	112
s1 (mm)	14.8
s2 (mm)	11.9
Weight (Kg)	3.69
Box Quantity (pcs)	2
Box Dimension (pcs)	36x30x49

INJECTION MOULDED

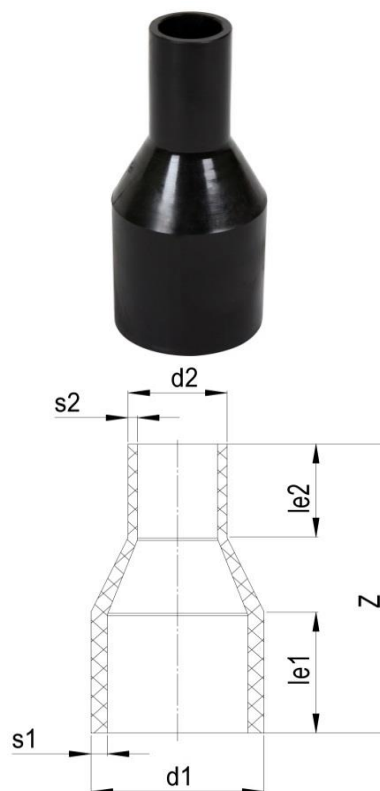

IDENTIFICATION OF PRODUCT

D(mm)	250-200
SDR	17
RAW METARIAL	PE 100
PRESSURE CLASS	10 Bar Water 5 Bar Gas
TRADEMARK	NTG
EXECUTION	Injection Moulded
STANDARD	EN 12201-3 EN 1555-3 AS /N/ZS 4129

SPECIFICATION

Long Spigot

Tolerance on diameters and thickness according to the standards. The other dimensions are specialized. Tolerance $\pm 5\%$. NTG PLASTIK reserves all the right to change any information without giving prior notice. The production, distribution and utilization of this document without explicit authorization is prohibited.

Fr 161 Rev 00