

Produkt-/FDV-dokumentasjon

NRF-nr.	Artikkelnavn
9716456	skiltholder buet US rondell f/stolpe/vegg

 Skiltholder buet for US rondell for vegg og stolpe komplett m/skruer, skiver og muttere

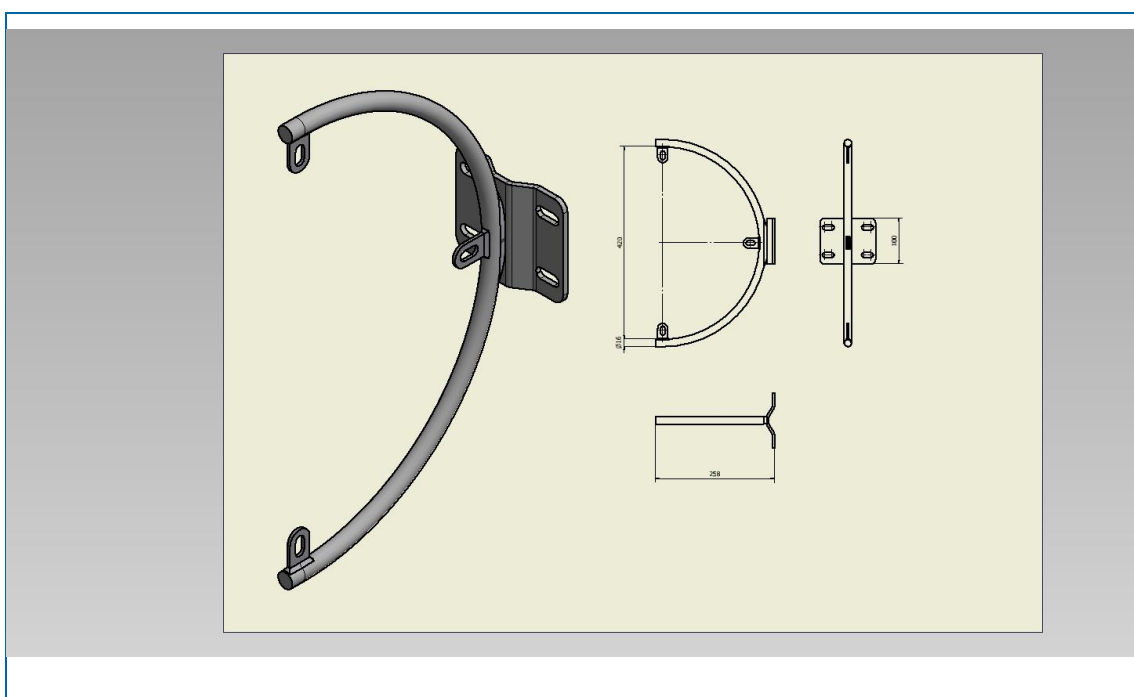

Fysiske data







Vekt: 1,70 kg Lengde: 452,00 mm

Volum: 38,7 dm³ Bredde: 121,00 mm

Høyde: 258,00 mm

 For US rondell

Teknisk beskrivelse

-  Solid skiltholder for rondell US størrelse
-  Galvanisert utførelse iht EN 10240
-  Bøyle i Ø16mm stål
-  Monteres fast på Ø60 stolpe eller monteres på vegg
-  CC skruehull 91mm
-  Monteringsplate 120,6mm x 100mm

Monteringsanvisning

Man trenger 2 stk 13mm fastnøkler eller skiftenøkkel for å montere skilt i holderen.
Husk å sette plastskivene mot folien på skiltet.

Vedlikehold- og avfallsinstruks

Intet vedlikehold er påkrev for dette produkt.
Leveres offentlig deponi som Metallavfall etter endt bruk.