

STAKERØR, Ø110MM
- Syrefast stål: AISI316L/EN1.4404

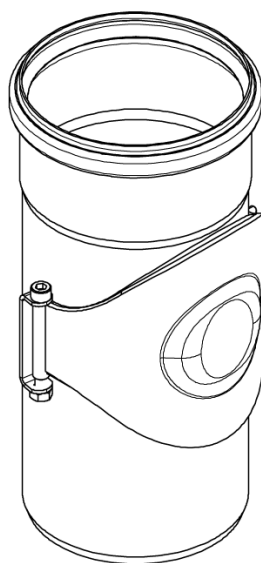

Type nr.: 840.110.110 S
EAN nr.: 5705499403800
VVS nr.: 160247410
RSK nr.: 1550325
NRF nr.: 2170845
LVI nr.: 0252934

Type: Stakeluke
Utløpsdia. (mm): 110
Vinkel (°): 180
Vekt (kg): 0,90
Materiale: AISI 316L
Materiale: EN 1.4404

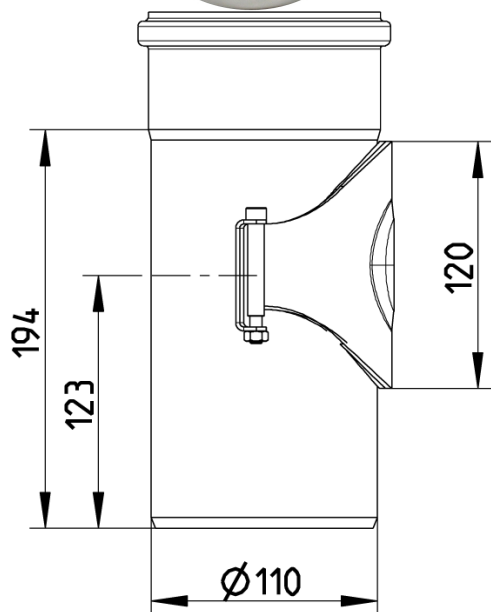

Godkjenninger

AUS - WMKT00204 - 18
Bureau Veritas - 02375-G0
DE - LGA Certificate 57214035 a
DK - VA 2.12/19349-16
DNV - TAP0000023-rev1
Lloyds Register 92-00041 (E6)
MARINE - R4547 NATO CODIFICATION SYSTEM
NO - 0692-12
PL - Hygenic Certificate - All products
RS - 14.10112.262
RU - 1682258
SE - SITAC 4423/90
UK - BBA 86-1751 EuroPipe
UR - 1055745