

BEND 30°, Ø160MM
- Syrefast stål: AISI316L/EN1.4404

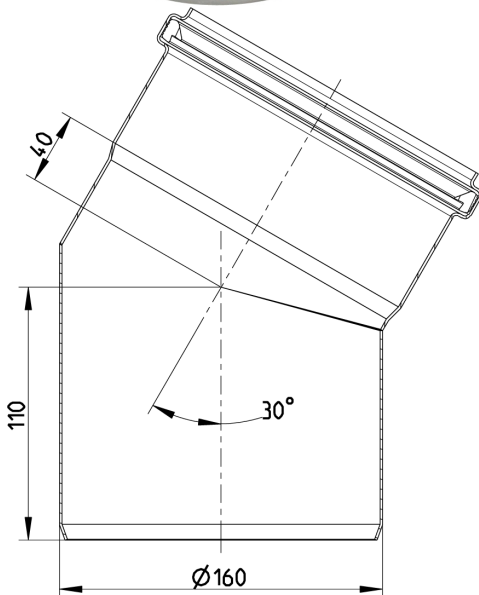

Type nr.: 820.030.160 S
EAN nr.: 5705499401295
VVS nr.: 160207460
RSK nr.: 1550296
NRF nr.: 2170768
LVI nr.: 0250635

Type: Bend
Utløpsdia. (mm): 160
Vinkel (°): 30
Vekt (kg): 1,15
Materiale: AISI 316L
Materiale: EN 1.4404



Godkjenninger

ABS - 04-LD472768/3

Achilles - 25316-17

AUS - WMKT00204 - 18

Bureau Veritas - 02375-G0

DE - LGA Certificate 57214035 a

DK - VA 2.12/19349-16

DK - VA 2.12/19350-16

DNV - TAP0000023-rev1

FR - DTA 14/12-1811*V1 EuroPipe

Lloyds Register 92-00041 (E6)

MARINE - R4547 NATO CODIFICATION SYSTEM

NO - 0692-12

PL - Hygenic Certificate - All products

RINA - MAC128714XG EuroPipe

RS - 14.10112.262

RU - 1682258

SE - SITAC 4423/90

UK - BBA 86-1751 EuroPipe

UR - 1055745

US - IAPMO File No.3247-16

