

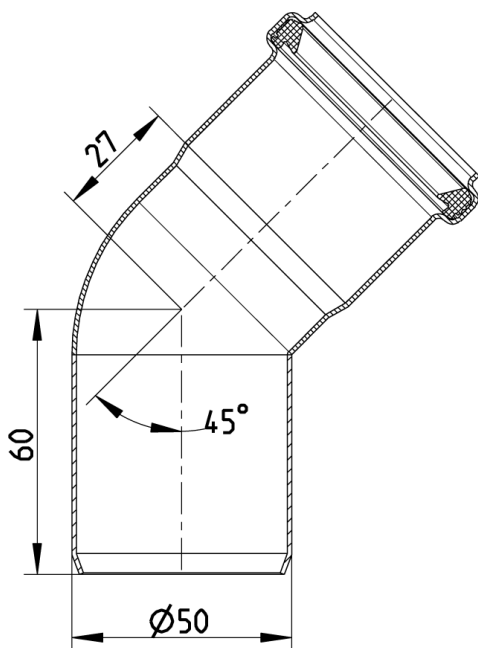

BEND 45°, Ø50MM
- Syrefast stål: AISI316L/EN1.4404

Type nr.: 820.045.050 S
EAN nr.: 5705499401318
VVS nr.: 160205350
RSK nr.: 1550289
NRF nr.: 2170754
LVI nr.: 0250682

Type: Bend
Utløpsdia. (mm): 50
Vinkel (°): 45
Vekt (kg): 0,17
Materiale: AISI 316L
Materiale: EN 1.4404



Godkjenninger

ABS - 04-LD472768/3
Achilles - 25316-17
AUS - WMKT00204 - 18
Bureau Veritas - 02375-G0
DE - LGA Certificate 57214035 a
DK - VA 2.12/19349-16
DNV - TAP0000023-rev1
Lloyds Register 92-00041 (E6)
MARINE - R4547 NATO CODIFICATION SYSTEM
NO - 0692-12
PL - Hygenic Certificate - All products
RINA - MAC128714XG EuroPipe
RS - 14.10112.262
RU - 1682258
SE - SITAC 4423/90
UK - BBA 86-1751 EuroPipe
UR - 1055745
US - IAPMO File No.3247-16

