

## TEKNISK DATABLAD



Dykkert type: F16 (16 GAUGE) RetDykkert  
 Diameter: 1,53 mm







## Passer til følgende verktøy\*:

Paslode	3250/65 F16Q, FN1665, FN1665.1, FN1650, IM65, IM250 II
Haubold	SKN50 L-I/16, SKN64 A/16
Duo-Fast	LFN SS764

\*sjekk dykkertlengde mot verktøy før bruk

Dykkertlengde: 15mm - 65mm  
 Dykkert pr. strip: 50

## KORROSJONSBESKYTTELSE

Overflate	Bruksområde	Fargekode
Elforsinket 1-2µm 7-15g/m <sup>2</sup>	 INNENDØRS BRUK	 Blå
Rustfritt stål A2 AISI 304 / Wnr 1.4301	 INNENDØRS, BESKYTTET UTENDØRS & UTENDØRS BRUK	 Gul
Rustfritt stål A4 AISI 316 / Wnr 1.4401	 INNENDØRS, BESKYTTET UTENDØRS & UTENDØRS BRUK	 Gul

## EGENSKAPER / DIMENSJONER

Strekfasthet:	Min 800N/mm <sup>2</sup>
Diameter (d):	1,53 mm
Dimensjon:	(A) 1,38 mm (B) 1,63 mm
Hodehøyde (D):	1,30 mm
Hodebredde (C):	2,90 mm
Strip lengde (Lp):	50 dykkert
Standard punkt:	Diamant 80°
Standard dykkert lengde (Lh):	15 mm - 65 mm

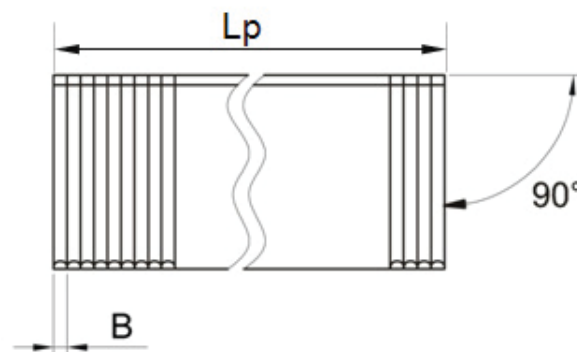
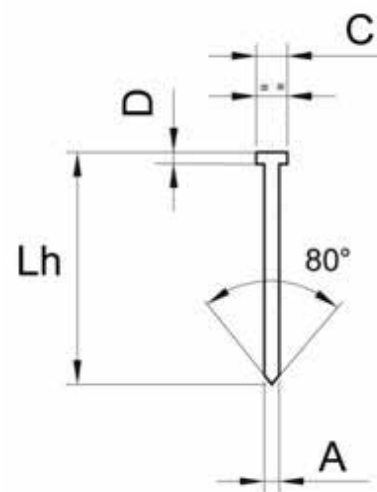

## TILGJENGELIGE DYKKERT LENGDER\*

Overflate	Tilgjengelige lengder
Elforsinket 1-2µm 7-15g/m <sup>2</sup>	* sjekk tilgjengelighet i Produktkatalogen 15mm, 20mm, 25mm, 30mm, 32mm, 35mm, 38mm, 45mm, 50mm, 60mm, 65mm
Rustfritt stål A2 AISI 304 / Wnr 1.4301	15mm, 25mm, 30mm, 32mm, 35mm, 38mm, 40mm, 50mm, 60mm
Rustfritt stål A4 AISI 316 / Wnr 1.4401	20mm, 25mm, 30mm, 35mm, 40mm, 50mm