

STORM ELITE DEHUMIDIFIER

INSTALLATION AND OPERATIONS MANUAL

– READ AND SAVE THESE INSTRUCTIONS –

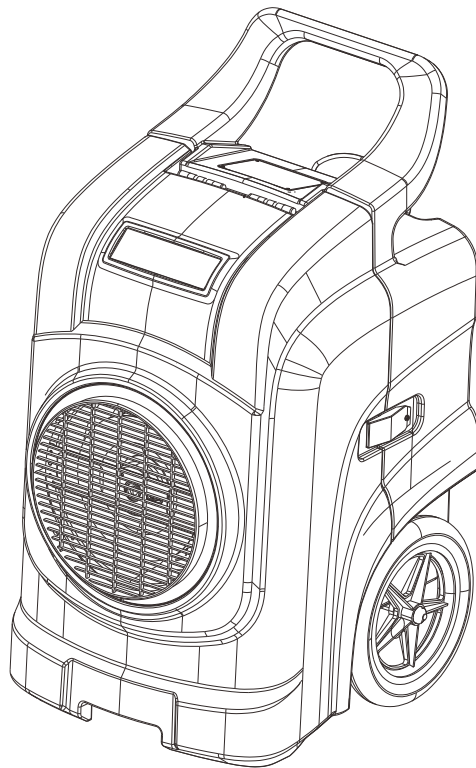

Patent Pending

Specifications subject to change without notice.

AlorAirSolutionsINC.

Add: 2048 E. Francis St Ontario CA 91761

Tel: 1-888-990-7469

E-mail: sales@alorair.com

※ Safety Notes ※

- The Storm Elite dehumidifier must always be connected using a grounded electrical connection as required for all electrical appliances. The warranty is voided and all responsibility for the operation transfers to the owner if non-grounded wiring is utilized.
- Your Storm Series dehumidifier must be maintained and serviced by qualified technicians.
- Storm dehumidifiers are intended for use only when the unit is installed in a level and upright position. Operating the unit in any other position could cause water to come in contact with the electrical components.
- Before moving the dehumidifier, turn off the unit and allow the pump reservoir to empty (if unit is already off, press "Purge" button to confirm drain reservoir is empty). After the pump has finished operation, unplug the power cord and relocate the unit to the desired position.
- If the inside of the machine has gotten wet for any reason, the unit should be opened and allowed to dry thoroughly before reconnecting it to electric and restarting.
- For proper operation, neither the inlet or discharge should be positioned against a wall. A minimum of 8" clearance between the Storm and any obstruction is required.
- Do not insert any objects or fingers into the inlet or discharge.
- All work on the machine should be done with the unit off and unplugged.
- Do not spray water or cleaner directly on the exterior of the unit. Only use a damp cloth to clean the exterior and always unplug the unit first.
- Do not use unit as shelf or device to hang clothes as this could cause damage to unit.
- Do not stand on the machine.

※ Table of Contents ※

Introduction	01
Unit Overview	03
LCD Display Introduction.....	04
Preparing the Unit for Use	09
Maintenance & Repair	11
Storing Your Dehumidifier	15
Troubleshooting	15
Warranty	17

✂ Introduction ✂

Identification

Congratulations on purchasing a Storm Elite dehumidifier! The Storm Elite comes with an extensive warranty plan. To ensure you are eligible, be sure to note the serial number and date of purchase. The serial number can be found on the data on the back of the unit.

Model Name: Storm Elite

Serial Number: _____ Date of Purchase: _____

Customer Service

For additional questions concerning the operation of your dehumidifier, please

- Contact your installing contractor
- Contact AlorAir Solutions: 1-888-990-7469
sales@alorair.com

Features

- 125 Pints Per Day
- High COP: 2.4 L/kWh
- Only 58 dBA
- Automatic Humidistat
- Built-in Pump with Overflow Protection
- Self Monitoring System
- Eco-Friendly R410A Refrigerant
- Easy Access to Internal Components
- Auto Restart After a Power Outage
- Unit Can be Ducted, If Necessary

How Your Storm Dehumidifier Works

The Storm Elite dehumidifier utilizes its integral humidistat to monitor the conditioned space. Once conditions are outside the desired setpoint, the compressor energizes and air is drawn across an evaporator coil. The evaporator coil is cooler than the dew point of the air so water vapor will turn into liquid condensation. The air is then reheated through the condenser coil and distributed back into the room.

Electrical Supply

WARNING 240 Volts may cause serious injury from electric shock.

Power Supply: 115V, 60 Hz AC Only 1Phase
 Outlet Requirement: 3-Prong, GFCI
 Circuit Protector: 15Amp TimeDelay or GFI Circuit Breaker

1. Disconnect electrical power before servicing
2. Only plug unit into grounded electrical outlet
3. Do not use an extension cord
4. Do not use a plug adapter

Installation

Place the Elite in your desired location. The inlet of the machine should be at least 8" from any obstructions. If the unit has been transported in a horizontal position, allow it to sit in an upright position for at least 30 minutes before operating.

WARNING

Do not use dehumidifier in an environment where corrosive or high VOC materials are applied.

※ Unit Overview ※

Front View

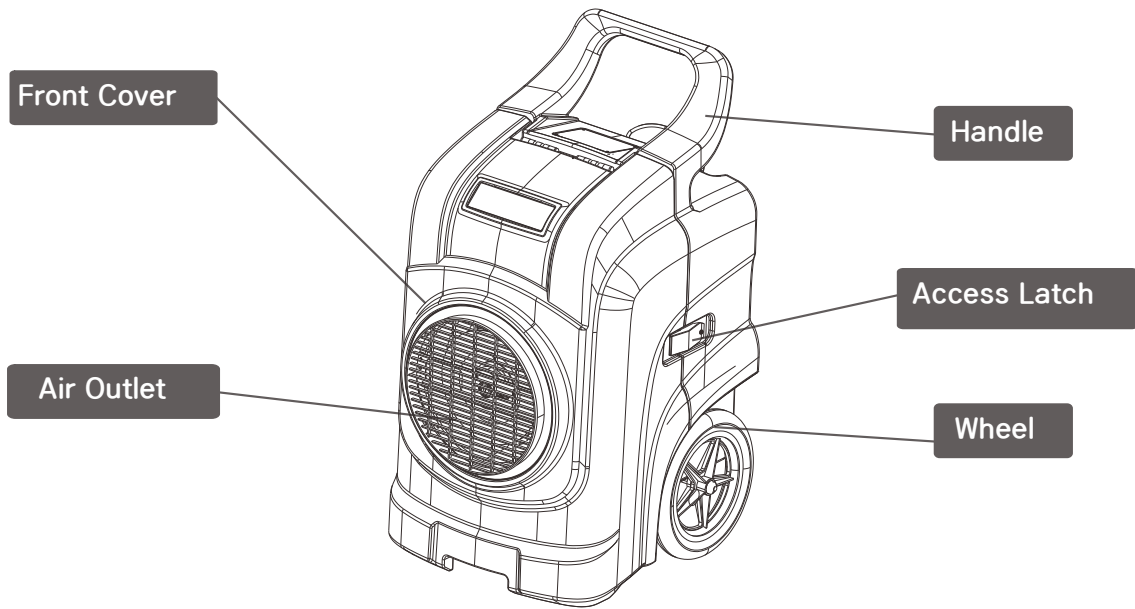

Rear View

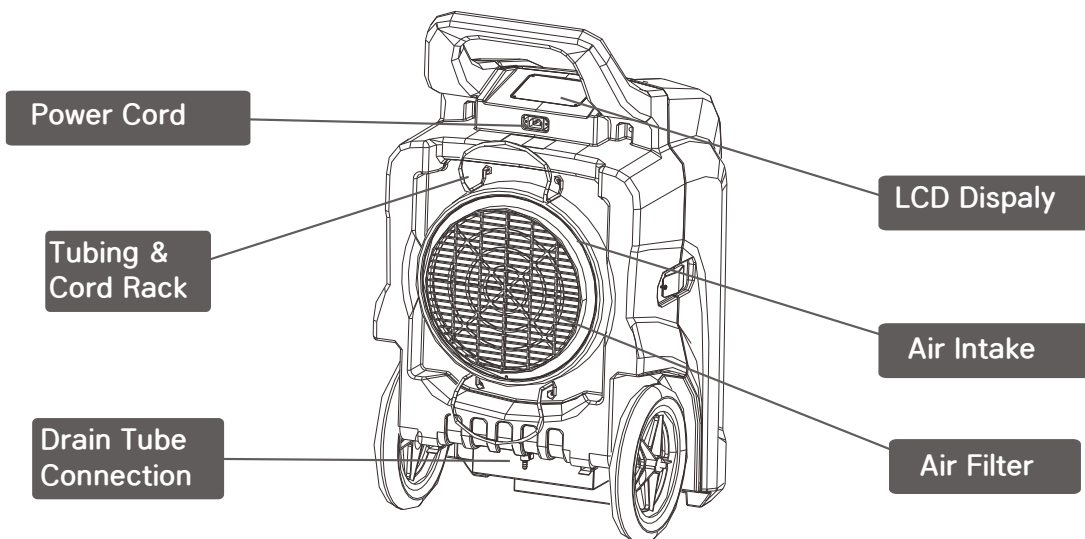

※ LCD Display Instructions ※

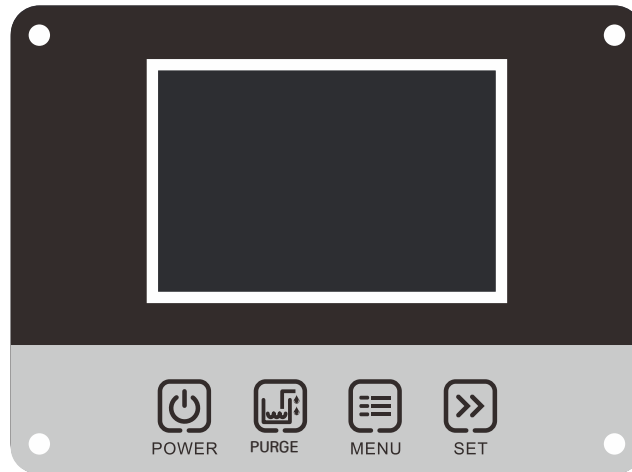

1. When the machine is powered on but not working:
(after power on, the buzzer makes a sound)

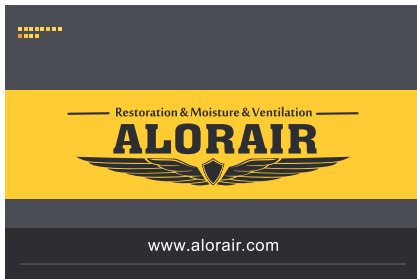

Boot display: The LOGO interface will disappear after 2 seconds. Enter the following interface



The machine displays when it is not working. (Power off state but have electricity)

2. Main interface display of dehumidification state:

The following information is displayed when the machine is working:

• **000 JOB HRS:**

Refers to the working time, which is defined as the time from starting up to shutting down, including the defrost time during the period, and the standby time after the humidity. The submenu has a reset function. If not, the working time shall be accumulated.

Total time 9999 hours, the largest cumulative to the largest automatically reset after restart, and display units for hours. (round off).

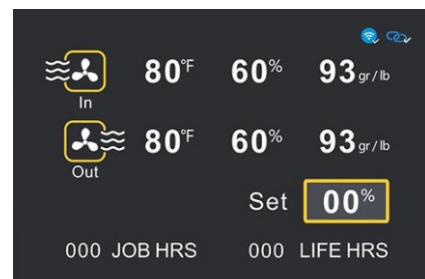

- 000 LIFE HRS:

Refers to the total working time, i.e. the total working time (hours), which is in hours. (Press the mode key + select the confirmation key, and the total working time will be cleaned after 3 seconds.)

- IN/OUT 00°F 00% 00 gr / lb:

Indicates the temperature, humidity and moisture content of the air inlet and outlet {GPP – grain per pound (gr/lb)}.

- Set 00%:

Indicates set humidity.

- If the main interface does not operate for 10 minutes, the screen will go out. Press any key to wake up.

- Other icons light up or flicker when opened

The total working time is the accumulation of each working time (hours) in hours. (Press the mode key + select to confirmation key, and the total working time will be cleaned after 3 seconds.)

3. Dehumidification status submenu interface display

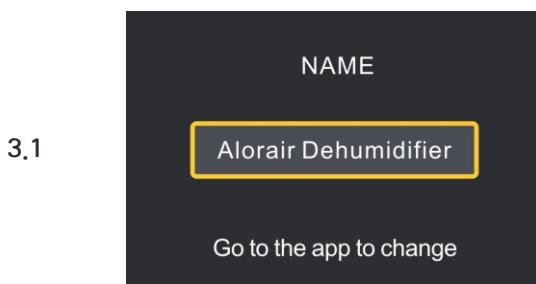

Device name displayed on the screen:
You can change the device name on the APP application

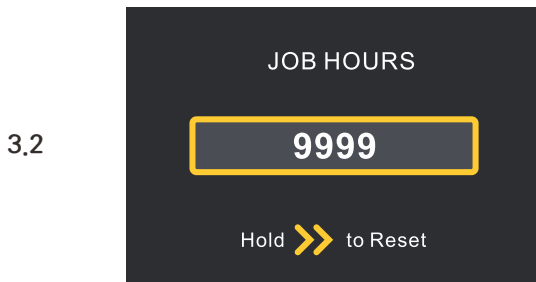

“Indicates”: Do I need to clear out this time?, press “)” if you need to clear. When the operation is completed, the working time of the main interface and the working time of this interface will be reset and started to be instant again. After accumulation (9999), clean up and round.

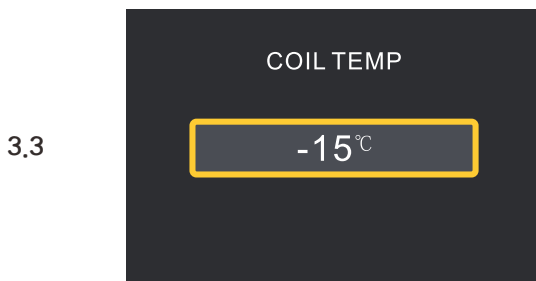

“Coil Temp 000°C ”: Used to display the current temperature of the coil. When it is below zero, the “-” symbol is displayed in front. “-” is not required on zero.

3.4

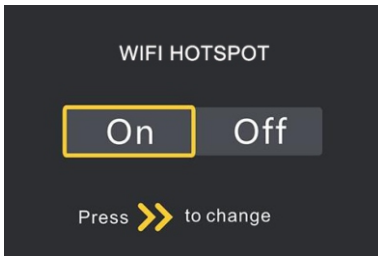

Wifi hotspot: factory setting is "OFF", press) to enable wifi hotspot and switch ON/OFF. The device can transmit data and receive APP commands. The icon flickers when connected on the main interface. After successful connection, the icon displays normally.

3.5.1

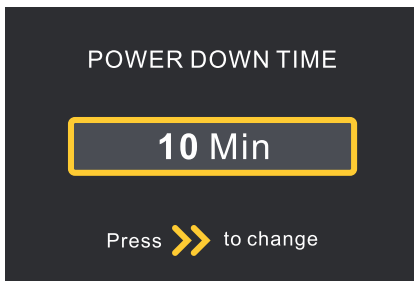

The power down time is adjusted according to")" and the power down time increases from 3 to 20 minutes (3-5-10-15-20), which is the so-called stop time of the fan after shutdown, in order to better drain the water. Factory set for 3 minutes. (the other state of the fan is still 15 seconds.)

3.5.2

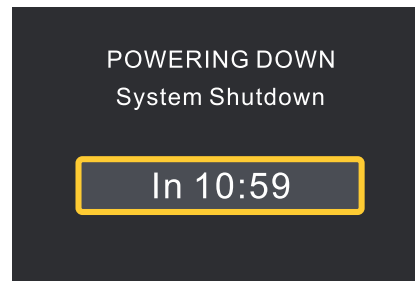

The screen displays when you press shut down:
Indicates: the fan is closed after a few minutes, and the standby page UNIT OFF is displayed after the fan is closed.

3.6

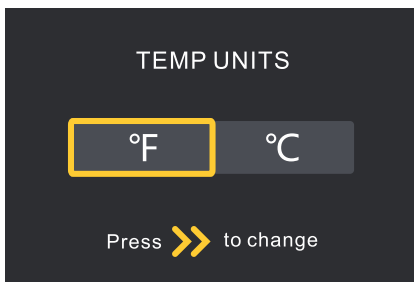

"Temp Units °F/°C": Used for temperature scale switching. Press the ") button to switch °F/°C, after switch symbol of corresponding parts is also changing.

3.7

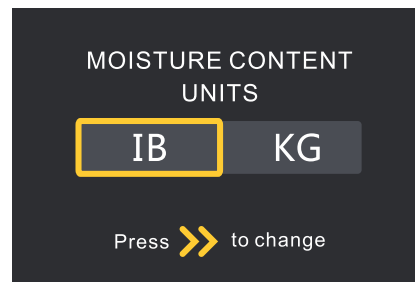

"MOISTURE CONTENT UNITS": It is used to switch the unit of GPP value with moisture content. Press) to switch the lb or Kg, after switch symbol of corresponding parts is also changing.

3.8

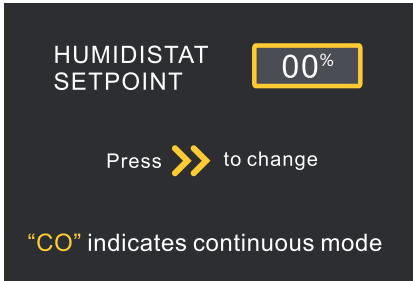

"Humidistat Setpoint 00%":Used for setting dehumidification mode humidity.Press ">" to set the humidity. The adjustment range of humidity setting is between 25 and 80%. Each key rises or falls 5%, which can be recycled.

When the setting is completed,do not operate for 5 seconds and begin to take effect. (Otherwise, the compressor will be shut down immediately after it is below ambient humidity at the time of setting.) Humidity below 25 percents "CO" mode recyclable. The main interface displays the set parameters,

4. Main interface frosting status display:

The machine will display this after defrost when running

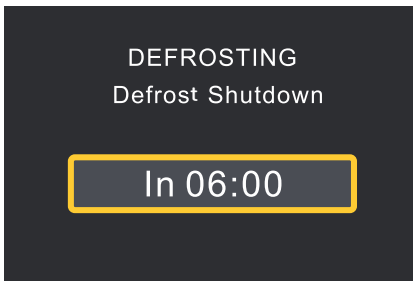

When the machine is running normally, "Defrost SHUTDOWN IN 06:00" will occurs in the interface after defrosting. It's defrost countdown use seconds as units. This screen displays only 3 seconds. Displays the previous interface and status after restoration.If it is the home screen, the frost icon will flash.

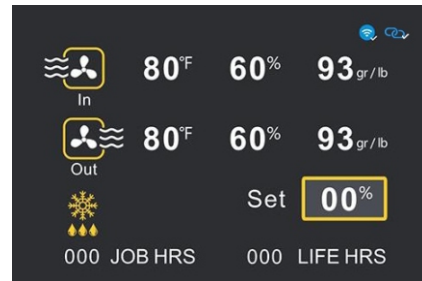

When the user is operating in the submenu, the machine is in the frosting state.At this point, the frosting interface displays 3 seconds, and returns to the submenu program in the background countdown,When the user returns to the main interface without any operation, the frosting state is displayed in the main interface in the way of icon flicker.

5. Compressor on waiting interface display

Compressor protection time not shown:

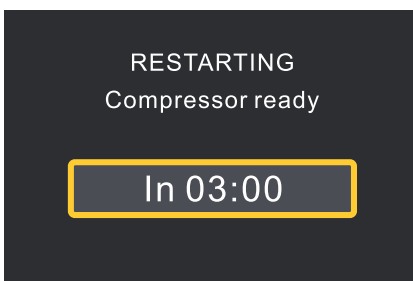

"Compressor ready IN 03:00" indicates : That the interface will be displayed when the compression is in a protected state. (including power-on and shutdown, the humidity rises immediately after the arrival of LO HI, and the shutdown resumes immediately. after the emergence of LO HI).Displays the countdown in seconds.If the above situation does not occur within 3 minutes, it is not shown.

6. Water Pump working interface display

Compressor protection time not shown:

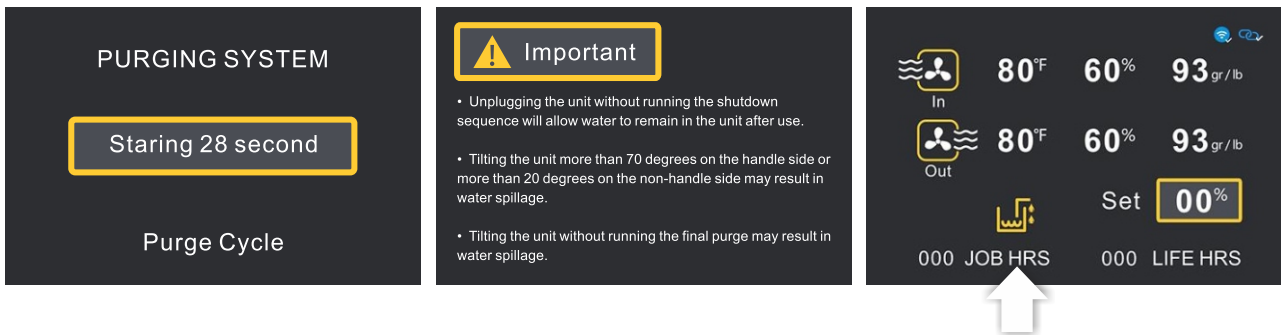

“Pump working countdown”: indicates: No matter in which working state and interface, as long as the pump works, this interface appears and counts down to 28 seconds. However, the interface only displays the previous working status and interface after 3 seconds. For example, after 3 seconds, there is a drainage icon on the main interface and it will flash until the drainage is finished.

7. Interface display in case of failure

Machine running time fault display:

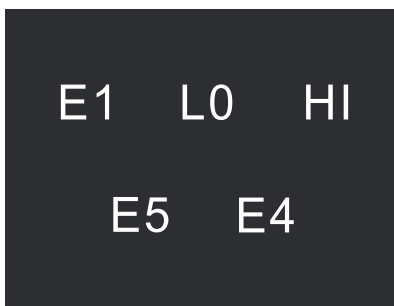

Make fault judgment and take corresponding actions after starting up. Regardless of the state, the fault is executed first and the fault code is displayed on the interface. If there is a fault in the sub-menu operation, immediately return to this interface display fault (including defrosting state). (the fault is judged when the pump works, and the fault is displayed as usual, but the pump needs to complete the water pumping this time). Multiple faults can be displayed at the same time.

Description of fault display:

- ◆ Humidity sensor fault: when the humidity sensor unit fault or signal can not be transmitted, the fault is judged to be E1. The machine is out of operation (power on again after troubleshooting). Pump button can operate.
- ◆ Ambient temperature $T \leq 2$: When the sensor continuously detects the ambient temperature of inlet air $T = 2$ degrees for 600 seconds, the fault is judged to be L0 and the whole machine is stopped. Other values, corresponding to the temperature region operation, (recoverable). At this time, the interface cannot be operated. The pump button can be operated.
- ◆ Ambient temperature $T \geq 45$: When the sensor continuously detects the inlet air environment temperature $T = 45$ degrees for 15 seconds, the fault is judged to be HI and the whole machine is stopped. Other values, corresponding to the temperature region operation, (recoverable). At this time, the interface cannot be operated. The pump button can be operated.

- ◆ When the compressor is started, if the coil temperature value detected is greater than or equal to (ambient temperature -3 degrees) for 30 minutes continuously, it is judged to be fluorine deficient (except defrosting), E5 is displayed, and the machine cannot be stopped for operation (it needs to be powered up again after troubleshooting). After the power is back on, the machine runs continuously for another 30 minutes for judgment.(the temperature probe is broken, the temperature needs to be minimal). The pump button can be operated.

- ◆ After the pump works for 28 seconds when the high water level is switched on, E4 fault is judged when the high water level switch is switched on for 3 consecutive seconds, and E4 fault is displayed. The machine stops and cannot be operated (the pump needs to be powered up again after troubleshooting). The pump can be operated.

※ Preparing the Unit for Use ※

Setup

1. Position the machine so there is a minimum of 8" clearance for the back and sides, or directly to a specific location for spot dry. If the compressor didn't remain vertical during transportation, wait a minimum of 30 minutes before turning the unit on.

2. The included drain line attaches to the unit via a quick connection fitting that is located on the base of the unit. The drain line should be routed to a suitable drain or outside. Since the unit has an integral drain pump, the drain line may go up vertically (no more than 15') prior to reaching the final drain location.

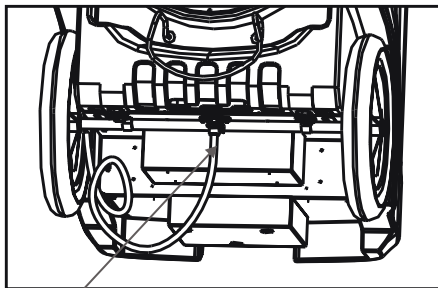

Quick Connection to Drain Tube

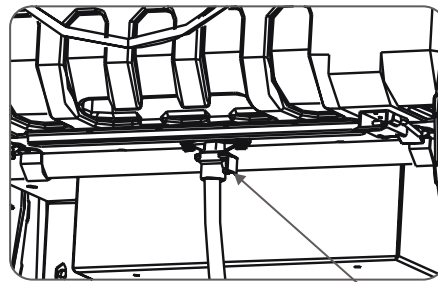

Quick Connect Fitting

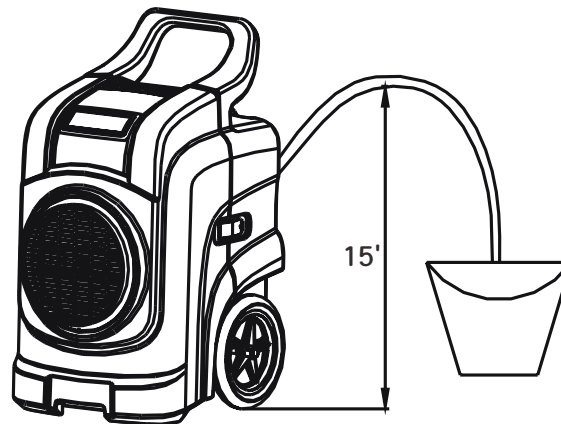

3. Firmly insert the power cord into the socket on back of the unit near the top.
4. Turn on the dehumidifier and use the control panel to set up the dehumidifier as desired.

Optional Duct Installation

Ducting of the unit allows you to condition an adjacent room or focus the discharge to a specific area. The inlet/return grill is designed for 12" flex duct while the supply grille is designed for 12" flex duct or layflat ducting.

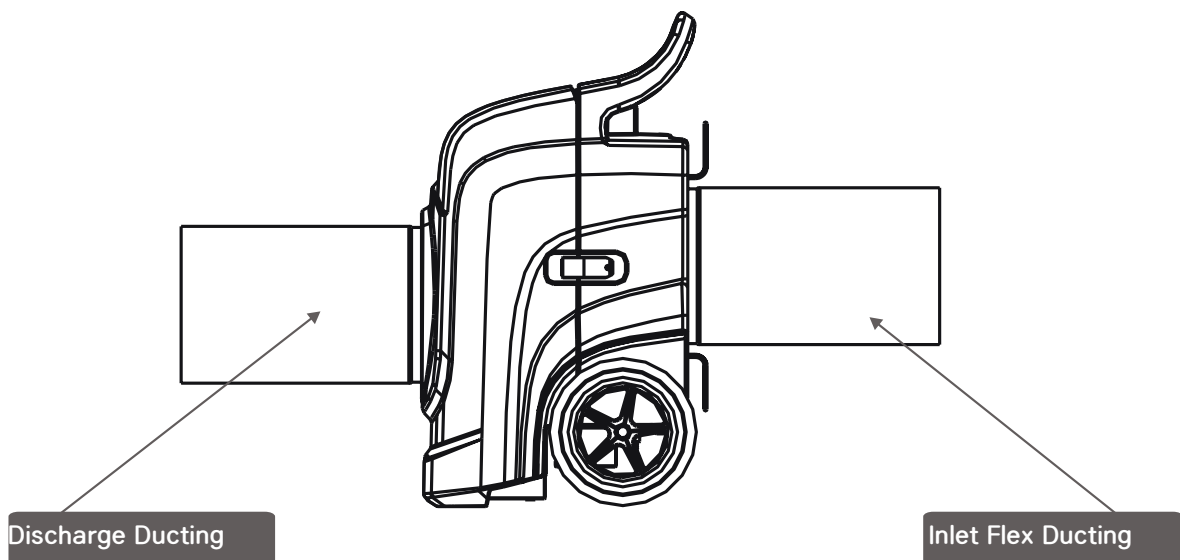

1. Maximum Total Duct Run = 20'
2. Maximum run if only ducting inlet or outlet= 12'
3. It may be helpful to remove the grilles from the end caps when connecting flex duct.

※ Maintenance and Repair ※

Exterior Cleaning

- Use a soft, slightly damp cloth to wipe the plastic body.
- Never spray the exterior directly with water or cleaner.

Filter Cleaning

The Elite comes standard with a prefilter and MERV-8 filter, which are washable.

NOTE: The carbon filter and HEPA filter (optional accessories) are NOT washable. Replace as needed.

1. To access the filter, rotate the inlet grille counter-clockwise. Remove the filter from.

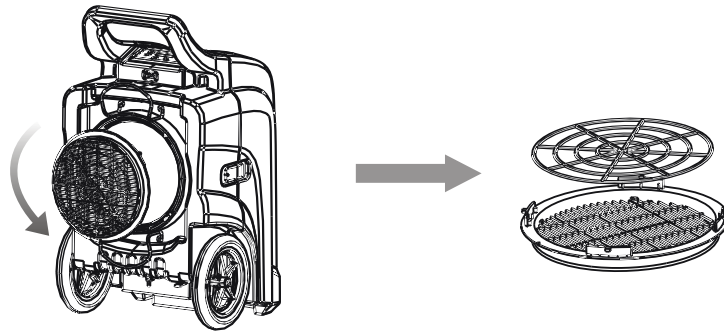

2. You can clean the filter by vacuuming it or rinsing it with warm water (no soap or solvents). Always make sure the filter is dry prior to restarting the unit.

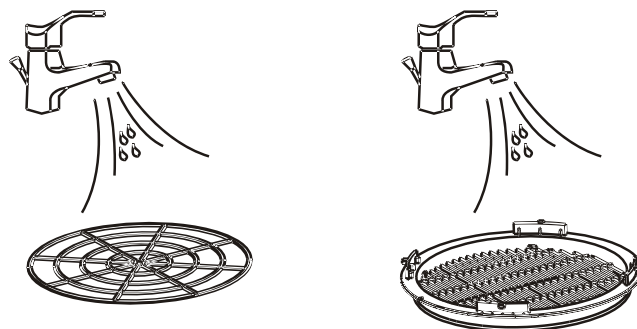

3. Place the filter back in the grille. Reinstall the grill by rotating clockwise.

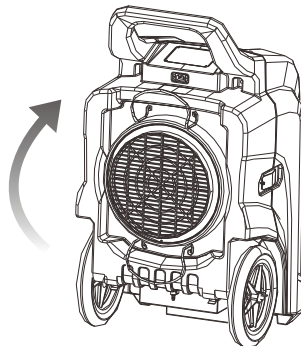

Accessing Internal Components

WARNING Always unplug unit prior to performing any maintenance.

1. Remove the screws from the side latches (one per side).

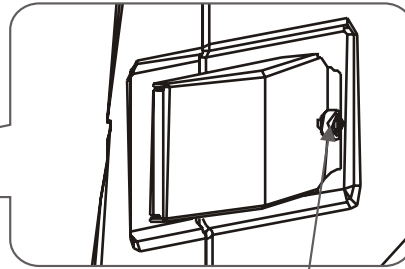
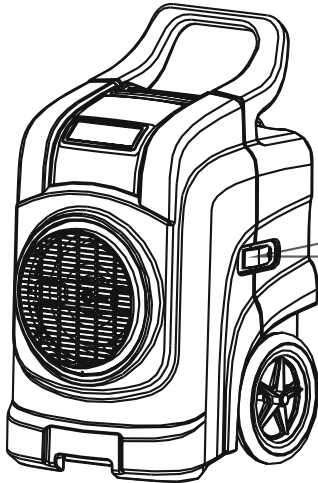

Remove the screw and open the latch (one per side)

2. Undo the two latches on the base of the unit by pressing in the safety then opening the latch.

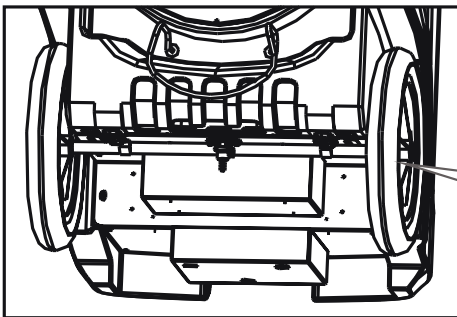

Squeeze safety and open latch

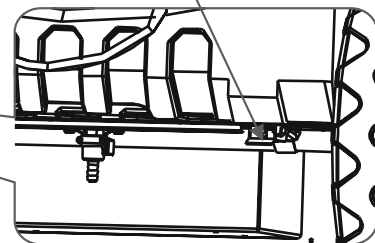

3. Lift open back housing.

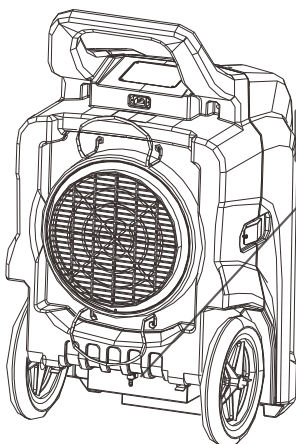

Lift open



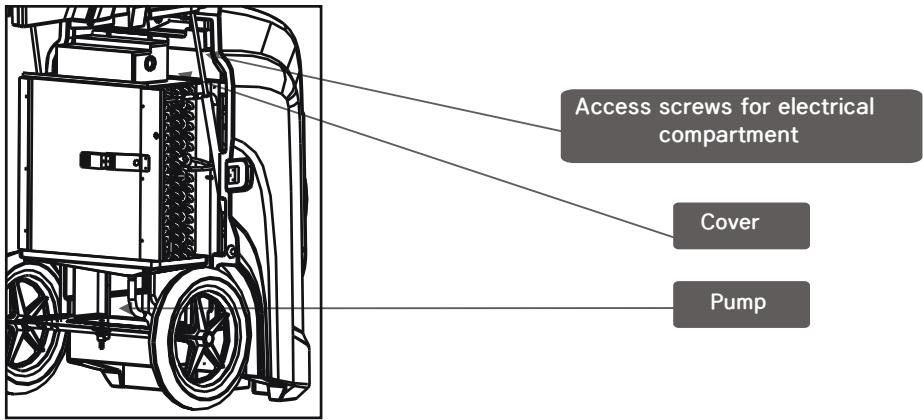

Integral Pump Maintenance

NOTE: This pump requires routine maintenance that is not covered by your 1 year parts warranty. Only a defective pump will be repaired or replaced under the warranty.

As with all pumps, preventative maintenance is necessary to prevent issues from dirt and slime that may accumulate in the drain system. This includes the drain pan, hose to the condensate pump, pump reservoir, pump head, float assembly, and discharge tubing

The pump is designed with quick connection construction, making it easy to access the pump and components for service and maintenance

To Remove Pump from Reservoir:

1. Unplug the unit.
2. Open the back housing as shown on page 12.
3. Remove the condensate tube from the pump.
4. Use the quick connect fittings to disconnect the main power and float switch electrical cables.
5. Use a flathead screw driver to gently pry the the pump off the reservoir.

At least once per year, clean your pump system.

Basic Pump Cleaning:

1. Press the pump button (Purge) to drain any water from reservoir.
2. Disconnect power to the dehumidifier.
3. Mix a 16 oz cleaning solution of one of the following: 1 oz bleach / 15 oz water or 4 oz white vinegar / 12 oz water. Pour the solution into the drain tray at the base of the coils.

NOTE: If you get any cleaning solution on the coils, flush with water

4. Allow cleaning solution to soak for 15 minutes.
5. Reconnect power to dehumidifier.
6. Pour clean water into reservoir so the pump activates twice (about 16–32 oz. water)
7. Repeat if needed or refer to Advanced instructions.

Advanced Pump Cleaning:

1. a. Use the manual pump button (Purge), to drain any water from reservoir.
b. Unplug the unit, and remove pump from reservoir (see page 13)
c. Use a wet dry vac or paper towels to remove any remaining water from the pump reservoir.
2. Fill the pump reservoir with cleaning solution (15 oz water / 1 oz bleach or 12 oz water / 4 oz white vinegar).
3. Reassemble the pump and use the manual pump button to flush the mixture through the discharge tubing.
4. Mix another batch of cleaning solution then pour it slowly into drain pan under evaporator coil and allow it to clean the hose from pan to pump. This process can be stopped when the pump energizes 1 time.
NOTE: If you get any bleach/water mixture on coils, flush with water.
5. Pour sufficient clean water through the drain pan so that the pump activates twice (16–32 ounces).
6. Reassemble the unit and return it to operational status.

Cleaning the Coils

The coils on your dehumidifier also need to be cleaned once per year. To clean, simply spray with a self-rinsing, foaming coil cleaner (such as WEB Coil Cleaner).

✂ Storing Your Dehumidifier ✂

If you plan on storing your dehumidifier for an extended period of time:

1. Turn unit off and allow to dry.
2. Manually drain pump reservoir.
3. Wrap and secure the power cord.
4. Clean the filter.
5. Store in clean, dry environment.

✂ Troubleshooting ✂

Symptom	Cause	Solution
Display is Blank	Poor Connection	Verify that both ends of the Power cord are plugged in
	Power Outage	Reset power
No Airflow	Filter is Dirty	Clean the filter
	Air Inlet or Outlet is Blocked	Clear the blockage
Error Code:E1	Humidity Sensor or Communication Error	Check to ensure that the sensor wire is connected at both ends, if no issues are visible, the sensor may be faulty.
Error Code:E4	Problem with Pump	Verify that the pump is properly installed and functioning. If so, unplug the unit for two minutes, then restart.
Error Code:LO	Room Temperature is below 33.8° F	Increase the room temperature so it is within operating range (above 33.8° F). If error still displays, check sensor.
Error Code:HI	Room Temperature is above 105° F	Decrease the room temperature so it is within operating range (below 105° F). If error still displays, check the sensor
E5 Error Code	Refrigerant Leak	Contact Your Installer for Assistance

Pump Alarm-Error Code E4

If an E4 code appears on the display:

1. Reset the unit by disconnecting the power cord and then reconnecting it.

NOTE: The unit will not function until the code has been cleared.

2. Manually check to see if pump is operational by pressing the drain button. Verify that the pump energizes and de-energizes properly. Additionally, check to see if any water purged from the system.

3. If you haven't cleaned the system recently, check the discharge line for an obstruction, then clean the balance of the pump system (see "Maintenance" section for details).

4. Replace the hoses and/or pump, if maintenance alone isn't sufficient.

❖ Warranty ❖

All warranty benefits apply to the original owner only. Warranty cannot be transferred or assigned.

1 YEAR (FROM DATE OF PURCHASE): AlorAir Solutions warrants the dehumidifier will operate free of defects in workmanship and materials. At its discretion, AlorAir will repair or replace any malfunctioning components, free of charge (excluding transportation costs)

3 YEARS (FROM DATE OF PURCHASE): AlorAir Solutions warrants the refrigeration circuit (compressor, condenser and evaporator) will operate free of defects in material or workmanship. At its discretion, AlorAir will replace defective parts, including factory labor or refrigerant. This does not include transportation.

5 YEARS (FROM DATE OF PURCHASE): AlorAir Solutions warrants the compressor, condenser, and evaporator will operate free of any defects in material or workmanship. At its discretion, AlorAir will repair or replace the defective parts. This does not include labor, transportation, or refrigerant.

CUSTOMER RESPONSIBILITIES: In order to take advantage of the warranty service, the customer must do the following:

1. Customer must provide normal care and maintenance (including, but not limited to cleaning filters, coils and pumps)
2. Removal and re-installation of unit is the sole responsibility of owner.
3. If customer cannot return unit to certified repair center, all costs associated with freight shipment are borne by the customer. In addition, all duties related to freight shipments, including but not limited to palletizing, wrapping, labeling, and pickup are associated with customer.
4. If shipped, customer is responsible for all risk of loss or damage.

AlorAir Warranty Steps:

1. Once goods are received, customers must log in www.alorair.com to fill out the warranty registration form and submit to AlorAir company. We will receive your purchasing and installation information and save it. If no warranty registration is sent to us, warranty period will begin the day the shipment left the warehouse. Please be sure to record serial # and date of installation. You will need this information to receive the RA number.
2. If warranty service is necessary, customers must contact AlorAir Tech Support by sales@alorair.com or local technical service phone to receive a Return Authorization (RA number). Once an RA has been issued, customers should bring the unit to a certified repair center. AlorAir will arrange the shipping to bring the unit back to the AlorAir warehouse (at the expense of the customers) if customers are not available.
3. After the unit has been received by AlorAir (whether at a repair center or the warehouse), AlorAir will have an initial inspection. If it is determined to be invalid warranty claim (see exclusions below), customers have to pay for all associated repair costs and shipping costs for units repair.
4. Customers can pick up the unit after repair at their own expense for shipping. Units will have a rigorous testing before sending it back to customers
5. Customer a new unit within the same year warranty from the date of replacement.
6. After parts are repaired or replaced by AlorAir, the original warranty period continues to apply until it meets its deadline.

Limited Warranty Exclusions

DAMAGE DUE TO THE FOLLOWING IS NOT COVERED UNDER WARRANTY

1. ACTS OF NATURE— INCLUDING BUT NOT LIMITED TO:
 - FLOODING
 - FIRE
 - WATER DAMAGE
 - HURRICANE/STORM DAMAGE
2. IMPROPER USAGE—INCLUDING BUT NOT LIMITED TO:
 - POOL/SPA/TUB APPLICATIONS
 - MISUSE, ABUSE, OR TAMPERING WHETHER INTENTIONAL OR ACCIDENTAL
 - IMPROPER INSTALLATION OR DESIGN
 - IMPROPER VOLTAGE
 - LACK OF NORMAL CARE
 - FAILURE TO FOLLOW INSTRUCTIONS
3. CORROSION
4. FREEZING
5. ANY ADDITIONAL COSTS DUE TO CHANGES IN LAWS OR BUILDING CODES
6. FREIGHT CHARGES
7. ANY COSTS DUE TO LOST PROFIT OR DELAY
8. DAMAGE TO PROPERTY
9. CAUSE BEYOND CONTROL
10. CONSUMABLE PARTS, INCLUDING BUT NOT LIMITED TO:
 - FILTERS
 - BATTERIES
 - POWER CORDS
 - VALVES
 - SWITCHES
 - RUBBER PARTS
11. DIRECT, INDIRECT, COLLATERAL OR INCONSEQUENTIAL DAMAGES OF ANY KIND

THE WARRANTIES AND LIABILITIES SET FORTH ARE IN LIEU OF ALL OTHER WARRANTIES EXPRESSED OR IMPLIED, IN LAW OR IN FACT, INCLUDING IMPLIED WARRANTIES OF MERCHANTABILITY AND FITNESS FOR PARTICULAR PURPOSE. ALORAIR SOLUTIONS'S TOTAL LIABILITY, REGARDLESS OF NATURE OF CLAIM SHALL NOT EXCEED ORIGINAL PURCHASE PRICE OF THE PRODUCT. IF A PRODUCT OR COMPONENT IS REPLACED WHILE UNDER WARRANTY, THE APPLICABLE WARRANTY PERIOD SHALL NOT BE EXTENDED BEYOND THE ORIGINAL WARRANTY TIME PERIOD.

THE FOREGOING SHALL CONSTITUTE THE TOTAL LIABILITY OF SELLER IN THE CASE OF DEFECTIVE PERFORMANCE OF ALL OR ANY OF THE EQUIPMENT OR SERVICES PROVIDED TO BUYER. BUYER AGREES TO ACCEPT AND HEREBY ACCEPTS THE FOREGOING AS THE SOLE AND EXCLUSIVE REMEDY FOR ANY BREACH OR ALLEGED BREACH OF WARRANTY BY SELLER

ANY DISHONESTY OR FRAUD IN CONNECTION WITH ALORAIR SOLUTIONS WARRANTY THOROUGHLY VOIDS ALL WARRANTY POLICIES. ALORAIR SOLUTIONS EXPRESSLY RESERVES THE RIGHT TO PURSUE LEGAL ACTION IN THE EVENT OF DISHONESTY, FRAUD, OR ATTEMPTED FRAUD.