

# SPIT HC6

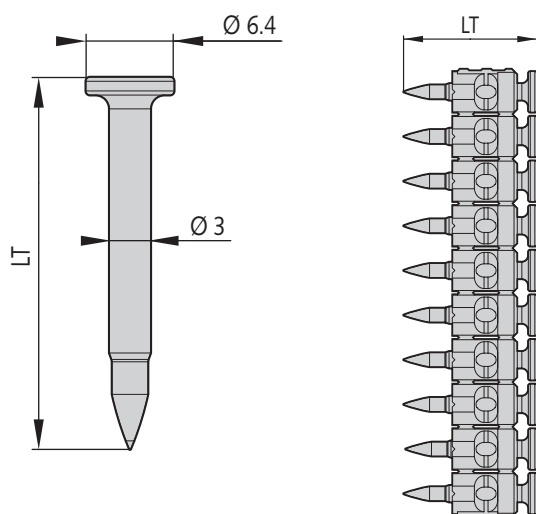

## DESCRIPTION

- Using with wiring accessories, to fix drywall track.
- Using in hard material, to improve the success rate.

## PROPERTIES MATERIAL

### Shank in carbon steel

- Total length Lt: 15, 17, 22, 27, or 32 mm
- Orange collated strip
- HC6 - 17, 22, 27, 32
- Mechanical zinc plating, min zinc coating 10 µm
- Hardness ≥ 56 HRc
- HC6 - 15
- Electrogalvanised, min zinc coating 5 µm
- Hardness: 53 to 56 HRc

## TOOLS

P800E - P800P / P800P+



## AGREEMENT

CSTB Technical approval 3/06 - 460

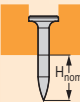

## PIN LENGTH SELECTION

HC6 range	Length shank	Orange strip 500 pcs/box
HC6-15	15	057550
HC6-17	17	057551
HC6-22	22	057552
HC6-27	27	057553
HC6-32	32	057554

## RECOMMENDED LOAD

HC6 range		Characteristic resistance		Recommended load	
		N <sub>Rk</sub> (kN)	V <sub>Rk</sub> (kN)	N <sub>Rec</sub> (kN)	V <sub>Rec</sub> (kN)
 C20/25 to C60/70	H <sub>nom</sub> = 15 mm	0.87	0.75	0.30	0.25
	H <sub>nom</sub> = 18 mm	1.19		0.40	
	H <sub>nom</sub> = 20 mm	1.41		0.47	
 f <sub>uk</sub> = 410 - 450 N/mm <sup>2</sup>	H <sub>nom</sub> = 6.5 mm	2.58	3.6	1.03	1.2
	H <sub>nom</sub> = 7.5 mm	2.91		1.16	
	H <sub>nom</sub> = 8.5 mm	3.24		1.30	
	H <sub>nom</sub> = 9.5 mm	3.57		1.43	
	H <sub>nom</sub> = 10 mm	3.74		1.49	

## APPLICATION LIMIT

-  Concrete: C50/60
-  Prestressed - Prefabricated concrete C60/70
-  Steel

Thickness of base material (mm)

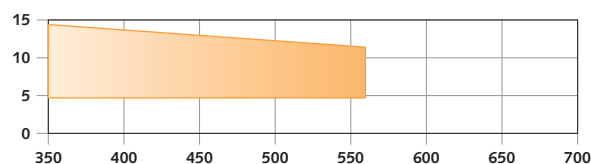

(1) E24	E28	E36	A60
(2) ST37	ST44	ST52	ST60
(3) S235	S275	S355	E335

(1) French designation - (2) German designation  
(3) Designation according to European standard NF EN 10027-1

Ultimate tensile strength of base material (N/mm<sup>2</sup>)