

## TEKNISK DATABLAD



Dykkert type: F16 (16 GAUGE) 20° Vinklet Dykkert  
 Diameter: 1,60 mm











## Passer til følgende verktøy\*:

Paslode FN16A65, IM65A, IM250A

\*sjekk dykkertlengde mot verktøy før bruk

Dykkertlengde: 32mm - 65mm  
 Dykkert pr. strip: 50

## KORROSIJONSBEKYTTELSE

Overflate	Bruksområde	Fargekode
Elforsinket	 INNENDØRS BRUK	 Blå
Rustfritt stål A2 AISI 304 / Wnr 1.4301	   INNENDØRS, BESKYTTET UTENDØRS & UTENDØRS BRUK	 Gul
Rustfritt stål A4 AISI 316 / Wnr 1.4401	   INNENDØRS, BESKYTTET UTENDØRS & UTENDØRS BRUK	 Gul

## EGENSKAPER / DIMENSJONER

Strekfasthet:	Min 650N/mm <sup>2</sup>
Diameter (d):	1,60 mm
Dimensjon:	(A) 1,35 mm (B) 1,60 mm
Hodehøyde (D):	0,75 mm
Hodebredde (C):	3,10 mm
Strip lengde (Lp):	50 dykkert
Standard punkt:	Diamant 60°
Standard dykkert lengde (Lh):	32 mm - 64 mm

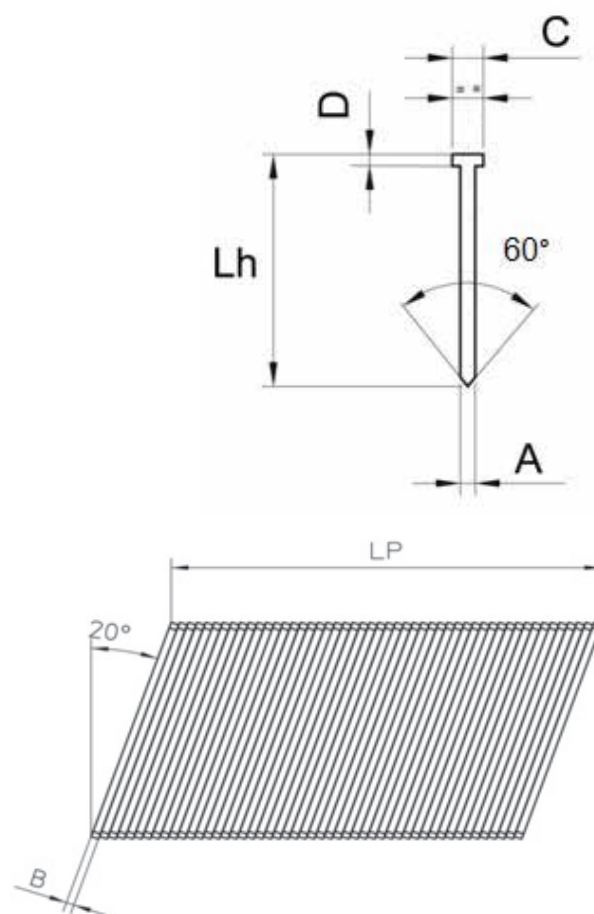

## TILGJENGELIGE DYKKERT LENGDER\*

Overflate	Tilgjengelige lengder * sjekk tilgjengelighet i Produktkatalogen
Elforsinket	32mm, 38mm, 45mm, 51mm, 64mm
Rustfritt stål A2 AISI 304 / Wnr 1.4301	32mm, 38mm, 50mm, 64mm
Rustfritt stål A4 AISI 316 / Wnr 1.4401	32mm, 38mm, 50mm, 64mm