



Expansion by impact anchor with female thread, for use in non-cracked concrete

HE-HO

ETA Assessed Option 7 for structural use and ETA assessed for non structural use. Zinc-plated steel.



PRODUCT INFORMATION

DESCRIPTION

Mechanical anchor, with female thread, for expansion by impact.

OFFICIAL DOCUMENTATION

- CE-1219-CPR-0078.
- CE-1219-CPR-0079.
- ETA 14/0135 option 7.
- ETA 14/0068 for multiple use for non-structural applications in concrete.
- Declaration of performance DoP HEHO.

SIZES

M6x25 to M20x80.

DESIGN LOAD RANGE

From 3,5 to 17,2 kN (non-cracked).



BASE MATERIAL

Concrete class C20/25 to C50/60 non-cracked (Structural).

Concrete class C12/15 to C50/60 (Non-structural).



Stone



Concrete



Reinforced Concrete

ASSESSMENTS

- Option 7 (non-cracked concrete).
- Multiple use.



14
Técnicas Expansivas S.L.
Segador 13. Logroño. Spain
ETA 14/0135, ETA 14/0068
1219
Structural / non structural fixings
in concrete

**FIRE**
RESISTANCE

CHARACTERISTICS AND BENEFITS

- Easy installation
- Working by deformation.
- Use in non-cracked concrete
- Use for medium-heavy duty loads.
- Pre-installation of the fixture.
- For static and quasi-static loads.
- Can be uninstalled leaving the surface clear (leaves the expansion item and the cone inside the drill hole).
- Screw isn't supplied.
- Available in INDEXcal.



MATERIALS

Sleeve: carbon steel, zinc-plated $\geq 5 \mu\text{m}$.

Cone: carbon steel, zinc-plated $\geq 5 \mu\text{m}$.



APPLICATIONS

- Fixings in suspenses ceilings, sprinkler and ventilation systems.
- Structural fixings, fittings in interiors and/or exteriors.
- Fixings of threaded rods.

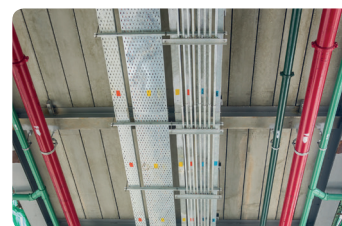



STRUCTURAL APPLICATION

MECHANICAL PROPERTIES

METRIC			M6	M8	M10	M12	M16	M20
A_s	(mm ²)	Threaded area section	20,1	36,6	58	84,3	157	245
STEEL GRADE OF THE SCREW			4.6	4.8	5.6	5.8	6.8	8.8
f_{uk}	(N/mm ²)	Screw characteristic resistance	400	400	500	500	600	800

INSTALLATION DATA

Metric		M6	M8	M10	M12	M16	M20
Code		HEHOM06	HEHOM08	HEHOM10	HEHOM12	HEHOM16	HEHOM20
d_0	Nominal diameter of drill bit [mm]	8	10	12	15	20	25
T_{ins}	Installation torque moment [Nm]	4	11	17	38	60	100
$d_{f\leq}$	Diameter of clearance hole in the fixture [mm]	7	9	12	14	18	22
h_1	Drill hole depth [mm]	27	33	43	54	70	86
h_{nom}	Installation depth [mm]	25	30	40	50	65	80
h_{ef}	Effective embedment depth [mm]	25	30	40	50	65	80
h_{min}	Minimum base material thickness [mm]	100	100	100	100	130	160
$s_{cr,N}$	Critical spacing [mm]	75	90	120	150	195	240
$c_{cr,N}$	Critical edge distance [mm]	38	45	60	75	98	120
$s_{cr,sp}$	Critical distance (splitting) [mm]	50	60	80	100	130	160
$c_{cr,sp}$	Critical edge distance (splitting) [mm]	75	90	120	150	195	240
s_{min}	Minimum spacing [mm]	60	60	80	100	130	160
c_{min}	Minimum edge distance [mm]	105	105	140	175	230	280

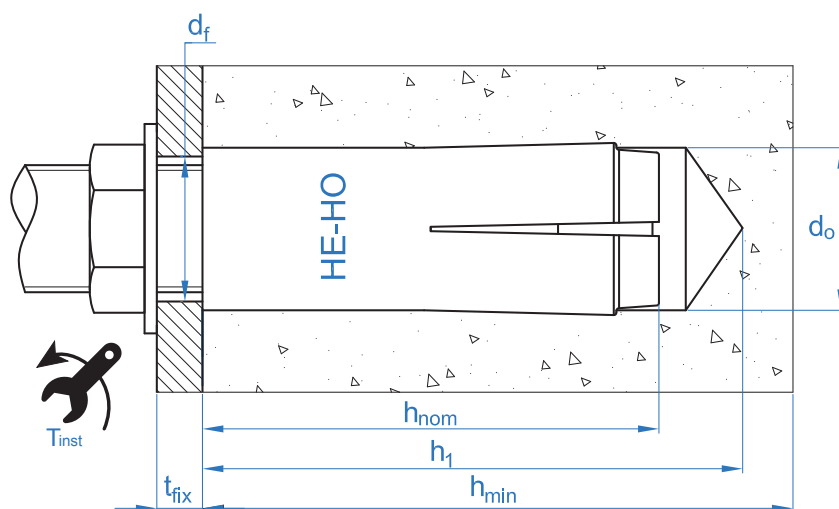

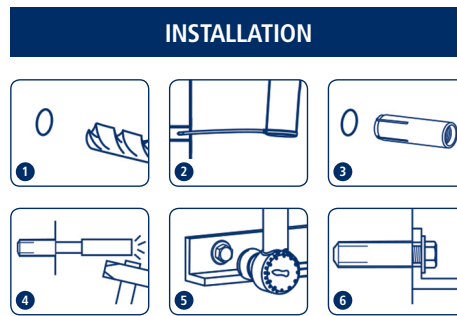

Code	INSTALLATION PRODUCTS
	Hammer drill
BHDSXXXXX	Concrete Drill bits
MOBOMBA	Blow pump
MORCEPKIT	Cleaning Brush
EXHBMXX	Manual expansion tool for drop in anchors
	Torque wrench
	Hexagonal socket

**HE-HO**

Resistances in C12/15 and from C20/25 to C50/60 concrete for an isolated anchor, without effects of edge distance or spacing

Characteristic Resistance N_{Rk} and V_{Rk}															
TENSION								SHEAR							
Metric		M6	M8	M10	M12	M16	M20	Metric		M6	M8	M10	M12	M16	M20
N_{Rk}	Non-cracked concrete [kN]	6,3	8,2	12,7	17,8	26,4	36,0	V_{Rk}	STEEL CLASS 4.6	4,0	7,3	11,6	16,8	31,4	49,0
									STEEL CLASS 4.8	4,0	8,3	9,1	17,8	31,4	47,5
									STEEL CLASS 5.6	5,0	9,1	9,1	17,8	39,2	61,2
									STEEL CLASS 5.8	5,0	8,3	9,1	17,8	32,5	47,5
									STEEL CLASS 6.8	6,3	8,3	9,1	17,8	32,5	47,5
									STEEL CLASS 8.8	6,3	8,3	9,1	17,8	32,5	47,5

Design Resistance N_{Rd} and V_{Rd}															
TENSION								SHEAR							
Metric		M6	M8	M10	M12	M16	M20	Metric		M6	M8	M10	M12	M16	M20
N_{Rd}	Non-cracked concrete [kN]	3,5	4,6	6,1	8,5	12,6	17,2	V_{Rd}	STEEL CLASS 4.6	5,0	9,1	9,1	17,8	39,2	61,2
									STEEL CLASS 4.8	3,2	5,5	7,3	11,9	25,1	38,0
									STEEL CLASS 5.6	3,0	5,4	5,4	11,9	23,5	36,6
									STEEL CLASS 5.8	4,0	5,5	7,3	11,9	26,0	38,0
									STEEL CLASS 6.8	4,2	5,5	7,3	11,9	26,0	38,0
									STEEL CLASS 8.8	4,2	5,5	7,3	11,9	26,0	38,0

Maximum Loads Recommended N_{rec} and V_{rec}															
TENSION								SHEAR							
Metric		M6	M8	M10	M12	M16	M20	Metric		M6	M8	M10	M12	M16	M20
N_{rec}	Non-cracked concrete [kN]	2,5	3,3	4,4	6,1	9,0	12,3	V_{rec}	STEEL CLASS 4.6	3,6	6,5	6,5	12,7	28,0	43,7
									STEEL CLASS 4.8	2,3	3,9	5,2	8,5	17,9	27,1
									STEEL CLASS 5.6	2,1	3,9	3,9	8,5	16,8	26,2
									STEEL CLASS 5.8	2,9	3,9	5,2	8,5	18,6	27,1
									STEEL CLASS 6.8	3,0	3,9	5,2	8,5	18,6	27,1
									STEEL CLASS 8.8	3,0	3,9	5,2	8,5	18,6	27,1



HE-HO

Simplified calculation method

European Technical Assessment ETA 14/0135

Simplified version of the calculation method according to ETAG 001, annex C. Resistance is calculated according to the data shown in assessment ETA 14/0135.

The calculation method is based on the following simplification: **Different loads do not act on individual anchors, without eccentricity.**

- Influence of concrete strength.
- Influence of edge distance.
- Influence of spacing between anchors.
- Influence of reinforcements.
- Influence of base material thickness.
- Influence of load application angle.
- Valid for a group of two anchors.



INDEXcal

For a more accurate calculation and to take more constructive provisions into account, we recommend using our calculation program INDEXcal. It may be easily downloaded from our website www.indexfix.com

TENSION LOADS

- Steel design resistance: $N_{Rd,s}$
- Pull-out design resistance: $N_{Rd,p} = N_{Rd,p}^o \cdot \psi_c$
- Concrete cone design resistance: $N_{Rd,c} = N_{Rd,c}^o \cdot \psi_b \cdot \psi_{s,N} \cdot \psi_{c,N} \cdot \psi_{re,N}$
- Concrete splitting design resistance: $N_{Rd,sp} = N_{Rd,c}^o \cdot \psi_b \cdot \psi_{s,sp} \cdot \psi_{c,sp} \cdot \psi_{re,N} \cdot \psi_{h,sp}$

Steel Design resistance							
$N_{Rd,s}$							
Metric		M6	M8	M10	M12	M16	M20
N_{Rd}^o	STEEL CLASS 4.6	4,0	7,3	11,6	16,9	31,4	49,0
	STEEL CLASS 4.8	5,3	9,7	12,1	22,5	41,9	63,4
	STEEL CLASS 5.6	5,1	9,2	9,1	21,1	39,3	61,3
	STEEL CLASS 5.8	6,7	11,7	12,1	23,4	43,3	63,4
	STEEL CLASS 6.8	8,1	11,7	12,1	23,4	43,3	63,4
	STEEL CLASS 8.8	8,7	11,7	12,1	23,4	43,3	63,4

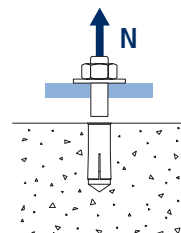

Pull-out design resistance							
$N_{Rd,p} = N_{Rd,p}^o \cdot \psi_c$							
Metric		M6	M8	M10	M12	M16	M20
$N_{Rd,p}^o$	Non-cracked concrete [kN]	-	-	-	-	-	-

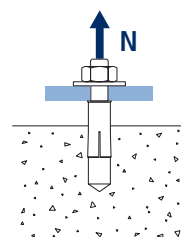

Concrete cone design resistance							
$N_{Rd,c} = N_{Rd,c}^o \cdot \psi_b \cdot \psi_{s,N} \cdot \psi_{c,N} \cdot \psi_{re,N}$							
Concrete splitting design resistance*							
$N_{Rd,sp} = N_{Rd,c}^o \cdot \psi_b \cdot \psi_{s,sp} \cdot \psi_{c,sp} \cdot \psi_{re,N} \cdot \psi_{h,sp}$							
Metric		M6	M8	M10	M12	M16	M20
$N_{Rd,c}^o$	Non-cracked concrete [kN]	3,5	4,6	6,1	8,5	12,6	17,2

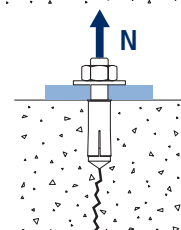
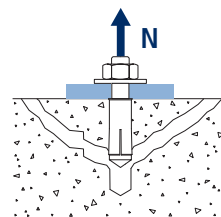

*Concrete splitting design resistance must only be considered for non-cracked concrete



HE-HO

Coefficients of influence

Influence of concrete strength resistance in pul-out failure ψ_c

		M6	M8	M10	M12	M16	M20
ψ_c	C 20/25	1,00	1,00	1,00	1,00	1,00	1,00
	C 30/37	1,02	1,22	1,15	1,15	1,22	1,19
	C 40/50	1,04	1,41	1,29	1,28	1,41	1,35
	C 50/60	1,05	1,55	1,37	1,37	1,55	1,46

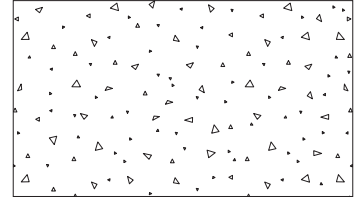
Influence of concrete strength in concret cone and splitting failure ψ_b

		M6	M8	M10	M12	M16	M20
ψ_b	C 20/25	1,00					
	C 30/37	1,22					
	C 40/50	1,41					
	C 50/60	1,55					

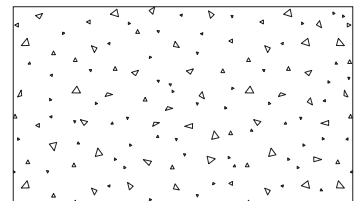

$$\psi_b = \sqrt{\frac{f_{ck,cube}}{25}} \geq 1$$



HE-HO

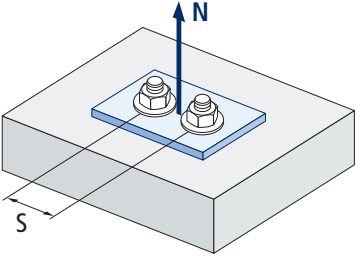

$$\psi_{s,N} = 0,5 + \frac{s}{2 \cdot s_{cr,N}} \leq 1$$

Influence of spacing (concrete cone) $\psi_{s,N}$						
s [mm]	HE-HO					
	M6	M8	M10	M12	M16	M20
60	0,90	0,83				
65	0,93	0,86				
70	0,97	0,89				
75	1,00	0,92				
80		0,94	0,83			
85		0,97	0,85			
90		1,00	0,88			
95			0,90			
100			0,92	0,83		
105			0,94	0,85		
110			0,96	0,87		
115			0,98	0,88		
120			1,00	0,90		
125				0,92		
130				0,93	0,83	
135				0,95	0,85	
140				0,97	0,86	
145				0,98	0,87	
150				1,00	0,88	
155					0,90	
160					0,91	0,83
165					0,92	0,84
170					0,94	0,85
175					0,95	0,86
180					0,96	0,88
185					0,97	0,89
190					0,99	0,90
195					1,00	0,91
200						0,92
205						0,93
210						0,94
215						0,95
220						0,96
225						0,97
230						0,98
235						0,99
240						1,00

Invalid value

Value without reduction = 1



Influence of spacing (concrete splitting) $\psi_{s,sp}$										
s [mm]	HE-HO									
	M6	M8	M10	M12	M16	M20				
60	0,70	0,67	Invalid value							
70	0,73	0,69								
80	0,77	0,72					0,67			
90	0,80	0,75					0,69			
100	0,83	0,78					0,71	0,67		
110	0,87	0,81					0,73	0,68		
120	0,90	0,83					0,75	0,70		
130	0,93	0,86					0,77	0,72	0,67	
140	0,97	0,89					0,79	0,73	0,68	
150	1,00	0,92					0,81	0,75	0,69	
160		0,94	0,83	0,77	0,71	0,67				
170		0,97	0,85	0,78	0,72	0,68				
180		1,00	0,88	0,80	0,73	0,69				
190			0,90	0,82	0,74	0,70				
200			0,92	0,83	0,76	0,71				
210			0,94	0,85	0,77	0,72				
220			0,96	0,87	0,78	0,73				
230			0,98	0,88	0,79	0,74				
240			1,00	0,90	0,81	0,75				
250				0,92	0,82	0,76				
260				0,93	0,83	0,77				
270				0,95	0,85	0,78				
280				0,97	0,86	0,79				
290				0,98	0,87	0,80				
300				1,00	0,88	0,81				
310					0,90	0,82				
320					0,91	0,83				
330					0,92	0,84				
340					0,94	0,85				
350					0,95	0,86				
360					0,96	0,88				
370					0,97	0,89				
380					0,99	0,90				
390					1,00	0,91				
400						0,92				
410						0,93				
420						0,94				
430						0,95				
440						0,96				
450						0,97				
460						0,98				
470						0,99				
480						1,00				

HE-HO

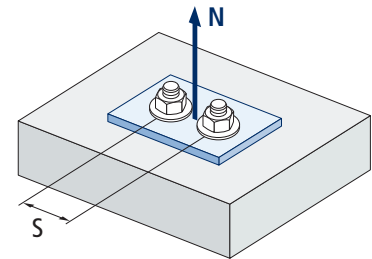

$$\psi_{s,sp} = 0,5 + \frac{s}{2 \cdot s_{cr,sp}} \leq 1$$



HE-HO

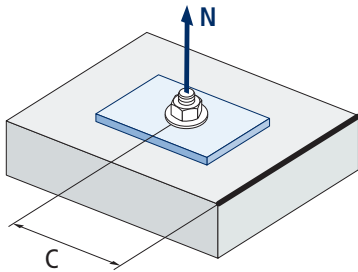

$$\psi_{c,sp} = 0,35 + \frac{0,5 \cdot c}{C_{cr,sp}} + \frac{0,15 \cdot c^2}{C_{cr,sp}^2} \leq 1$$

Influence of concrete edge distance (splitting) $\psi_{c,sp}$							
s [mm]	HE-HO						
	M6	M8	M10	M12	M16	M20	
60	Invalid value						
65							
70							
75							
80							
85							
90							
95							
100							
105							1,00*
110	Value without reduction = 1						
115							
120							
125							
130							
135							
140			1,00*				
145							
150							
155							
160							
165							
170							
175			1,00*				
180							
185							
190							
195							
200							
205							
210							
215							
220							
225							
230					1,00*		
235							
240							
250							
260							
270							
280						1,00*	

*Installation below the minimum concrete edge distance is not allowed



Influence of concrete edge distance (concrete cone) $\psi_{c,N}$						
s [mm]	HE-HO					
	M6	M8	M10	M12	M16	M20
60						
65						
70						
75						
80						
85						
90						
95						
100						
105	1,00*	1,00*				
110						
115						
120						
125						
130						
135						
140			1,00*			
145						
150						
155						
160						
165						
170						
175				1,00*		
180						
185						
190						
195						
200						
205						
210						
215						
220						
225						
230					1,00*	
235						
240						
250						
260						
270						
280						1,00*

HE-HO

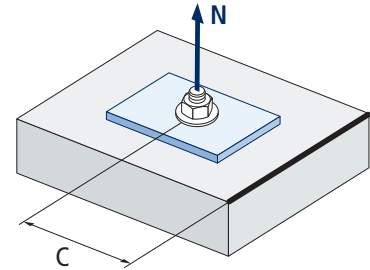

$$\psi_{c,N} = 0,35 + \frac{0,5 \cdot c}{C_{cr,N}} + \frac{0,15 \cdot c^2}{C_{cr,N}^2} \leq 1$$

*Installation below the minimum concrete edge distance is not allowed



HE-HO

Influence of reinforcements $\Psi_{re,N}$

$\Psi_{re,N}$	HE-HO					
	M6	M8	M10	M12	M16	M20
	0,625	0,650	0,700	0,750	0,825	0,900

*This factor only applies for a high density of reinforcements. If in the area of the anchor there are reinforcements with a distancing of ≥ 150 mm (any diameter) or with a diameter ≤ 10 mm and a distancing of ≥ 100 mm, a $f_{re,N} = 1$ factor may be applied.

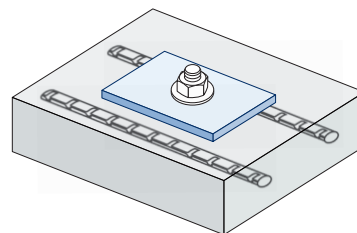

$$\Psi_{re,N} = 0,5 + \frac{h_{ef}}{200} \leq 1$$

Influence of base material thickness $\Psi_{h,sp}$

$\Psi_{h,sp}$	h/h _{ef}	HE-HO									
		2,00	2,20	2,40	2,60	2,80	3,00	3,20	3,40	3,60	$\geq 3,68$
	f _h	1,00	1,07	1,13	1,19	1,25	1,31	1,37	1,42	1,48	1,50

$$\Psi_{h,sp} = \left(\frac{h}{2 \cdot h_{ef}} \right)^{2/3} \leq 1,5$$

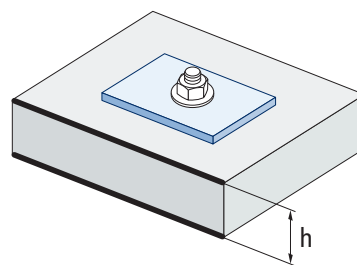

SHEAR LOADS

- Steel design resistance without lever arm: $V_{Rd,s}$
- Pry-out design resistance: $V_{Rd,cp} = k \cdot N_{Rd,c}^o$
- Concrete edge design resistance: $V_{Rd,c} = V_{Rd,c}^o \cdot \Psi_b \cdot \Psi_{se,V} \cdot \Psi_{c,V} \cdot \Psi_{re,V} \cdot \Psi_{\alpha,V} \cdot \Psi_{h,V}$

Steel design resistance

		$V_{Rd,s}$					
Metric		M6	M8	M10	M12	M16	M20
$V_{Rd,s}$	STEEL CLASS 4.6	2,4	4,4	6,9	10,1	18,8	29,3
	STEEL CLASS 4.8	3,2	5,8	7,3	13,4	25,1	38,0
	STEEL CLASS 5.6	3,0	5,4	5,4	12,6	23,5	36,6
	STEEL CLASS 5.8	4,0	7,0	7,3	14,0	26,0	38,0
	STEEL CLASS 6.8	4,8	7,0	7,3	14,0	26,0	38,0
	STEEL CLASS 8.8	5,2	7,0	7,3	14,0	26,0	38,0

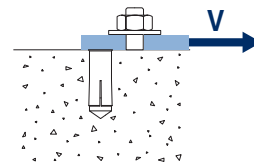

Pry-out design resistance*

		$V_{Rd,cp} = k \cdot N_{Rd,c}^o$					
Metric		M6	M8	M10	M12	M16	M20
	k	1	1	1	1	2	2

* $N_{Rd,c}^o$ Concrete cone design resistance for tension loads

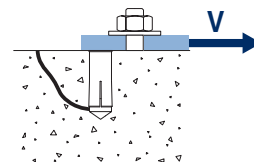

Concrete edge resistance

		$V_{Rd,c} = V_{Rd,c}^o \cdot \Psi_b \cdot \Psi_{se,V} \cdot \Psi_{c,V} \cdot \Psi_{re,V} \cdot \Psi_{\alpha,V} \cdot \Psi_{h,V}$					
Metric		M6	M8	M10	M12	M16	M20
$V_{Rd,c}^o$	Non-cracked concrete [kN]	2,2	2,9	4,7	6,8	10,3	14,4

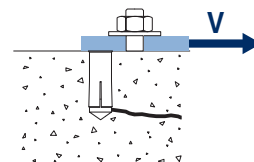



HE-HO

Coefficients of influence

Influence of concrete strength in concrete edge failure Ψ_b

		M6	M8	M10	M12	M16	M20	
Ψ_b	C 20/25	1,00						
	C 30/37	1,22						
	C 40/50	1,41						
	C 50/60	1,55						

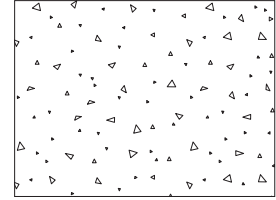

$$\Psi_b = \sqrt{\frac{f_{ck,cube}}{25}} \geq 1$$

Influence of edge distance and spacing $\Psi_{se,V}$

FOR ONE ANCHOR ONLY

c/h_{ef}	0,50	0,75	1,00	1,25	1,50	1,75	2,00	2,25	2,50	2,75	3,00	3,25	3,50	3,75	4,00	4,50	5,00
Isolated	0,35	0,65	1,00	1,40	1,84	2,32	2,83	3,38	3,95	4,56	5,20	5,86	6,55	7,26	8,00	9,55	11,18

FOR TWO ANCHORS

c/h_{ef}	0,50	0,75	1,00	1,25	1,50	1,75	2,00	2,25	2,50	2,75	3,00	3,25	3,50	3,75	4,00	4,50	5,00	
s/c	1,0	0,24	0,43	0,67	0,93	1,22	1,54	1,89	2,25	2,64	3,04	3,46	3,91	4,37	4,84	5,33	6,36	7,45
	1,5	0,27	0,49	0,75	1,05	1,38	1,74	2,12	2,53	2,96	3,42	3,90	4,39	4,91	5,45	6,00	7,16	8,39
	2,0	0,29	0,54	0,83	1,16	1,53	1,93	2,36	2,81	3,29	3,80	4,33	4,88	5,46	6,05	6,67	7,95	9,32
	2,5	0,32	0,60	0,92	1,28	1,68	2,12	2,59	3,09	3,62	4,18	4,76	5,37	6,00	6,66	7,33	8,75	10,25
	≥ 3,0	0,35	0,65	1,00	1,40	1,84	2,32	2,83	3,38	3,95	4,56	5,20	5,86	6,55	7,26	8,00	9,55	11,18

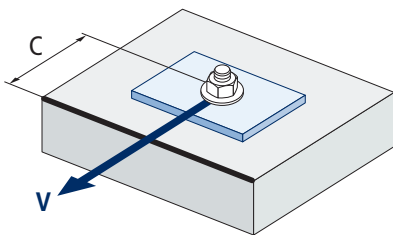

$$\Psi_{se,V} = \left(\frac{c}{h_{ef}}\right)^{1,5}$$

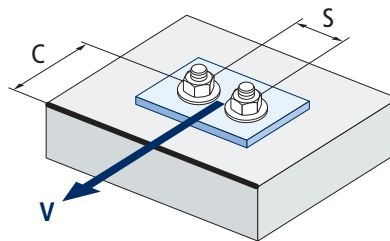

$$\Psi_{se,V} = \left(\frac{c}{h_{ef}}\right)^{1,5} \cdot \left(1 + \frac{s}{3 \cdot c}\right) \cdot 0,5 \leq \left(\frac{c}{h_{ef}}\right)^{1,5}$$



HE-HO

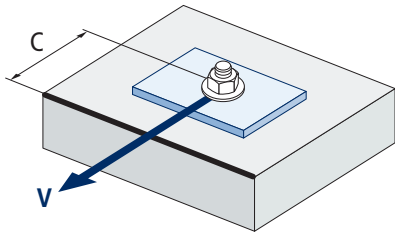

$$\psi_{c,v} = \left(\frac{d}{c} \right)^{0,20}$$

Influence of concrete edge distance $\psi_{c,v}$						
c [mm]	HE-HO					
	M6	M8	M10	M12	M16	M20
40	Invalid value					
45						
50						
55						
60						
65						
70						
80						
85						
90						
100						
105	0,56	0,60				
110	0,56	0,59				
120	0,55	0,58				
125	0,54	0,58				
130	0,54	0,57				
135	0,54	0,57				
140	0,53	0,56	0,59			
150	0,53	0,56	0,58			
160	0,52	0,55	0,57			
170	0,51	0,54	0,57			
175	0,51	0,54	0,56	0,59		
180	0,51	0,54	0,56	0,58		
190	0,50	0,53	0,55	0,58		
200	0,50	0,53	0,55	0,57		
210	0,49	0,52	0,54	0,56		
220	0,49	0,52	0,54	0,56		
230	0,48	0,51	0,53	0,55	0,59	
240	0,48	0,51	0,53	0,55	0,58	
250	0,47	0,50	0,53	0,54	0,58	
260	0,47	0,50	0,52	0,54	0,57	
270	0,47	0,49	0,52	0,54	0,57	
280	0,46	0,49	0,51	0,53	0,56	0,59
290	0,46	0,49	0,51	0,53	0,56	0,59
300	0,46	0,48	0,51	0,53	0,56	0,58



Influence of reinforcements $\Psi_{re,v}$			
	Without perimetral reinforcements	Perimetral reinforcements $\geq \text{Ø}12 \text{ mm}$	Perimetral reinforcements with brackets $\leq 100 \text{ mm}$
Non-cracked concrete	1	1	1

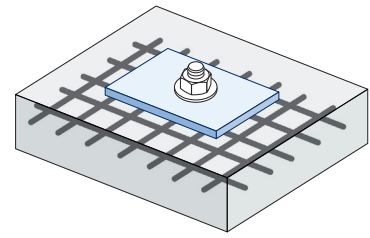

Influence of load application angle $\Psi_{\alpha,v}$										
Angle, $\alpha(^{\circ})$	0°	10°	20°	30°	40°	50°	60°	70°	80°	90°
$\Psi_{\alpha,v}$	1,00	1,01	1,05	1,13	1,24	1,40	1,64	1,97	2,32	2,50

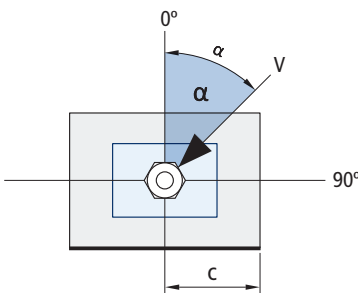

$$\Psi_{\alpha,v} = \sqrt{\frac{1}{(\cos \alpha_v)^2 + \left(\frac{\sin \alpha_v}{2,5}\right)^2}} \geq 1$$

Influence of base material thickness $\Psi_{h,v}$										
HE-HO										
h/c	0,15	0,30	0,45	0,60	0,75	0,90	1,05	1,20	1,35	$\geq 1,5$
$\Psi_{h,v}$	0,32	0,45	0,55	0,63	0,71	0,77	0,84	0,89	0,95	1,00

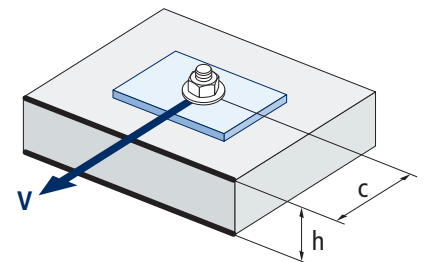

$$\Psi_{h,v} = \left(\frac{h}{1,5 \cdot c}\right)^{0,5} \geq 1,0$$



NON-STRUCTURAL APPLICATION

MECHANICAL PROPERTIES								
METRIC			M6	M8	M10	M12	M16	M20
A_s	(mm ²)	Threaded area section	20,1	36,6	58	84,3	157	245
STEEL GRADE OF THE SCREW			4.6	4.8	5.6	5.8	6.8	8.8
f_{uk}	(N/mm ²)	Screw characteristic resistance	400	400	500	500	600	800

INSTALLATION DATA								
Metric			M6	M8	M10	M12	M16	M20
Code			HEHOM06	HEHOM08	HEHOM10	HEHOM12	HEHOM16	HEHOM20
d_0	Nominal diameter of drill bit	[mm]	8	10	12	15	20	25
T_{ins}	Installation torque moment	[Nm]	4	11	17	38	60	100
$d_{f \leq}$	Diameter of clearance hole in the fixture	[mm]	7	9	12	14	18	22
h_1	Drill hole depth	[mm]	27	33	43	54	70	86
h_{nom}	Installation depth	[mm]	25	30	40	50	65	80
h_{ef}	Effective embedment depth	[mm]	25	30	40	50	65	80
h_{min}	Minimum base material thickness	[mm]	100	100	100	100	130	160
s_{min}	Minimum spacing	[mm]	60	60	80	100	130	160
c_{min}	Minimum edge distance	[mm]	105	105	140	175	230	280
s_{cr}	Critical spacing	[mm]	150	180	240	300	390	480
c_{cr}	Critical edge distance	[mm]	75	90	120	150	195	240

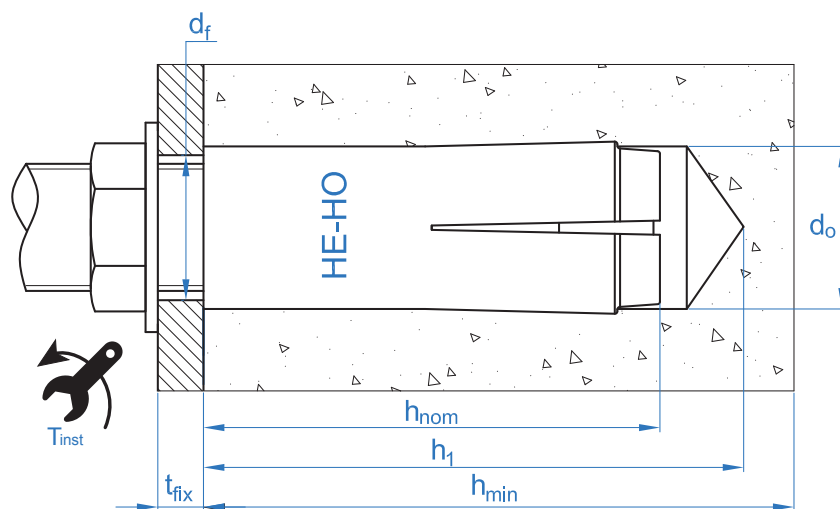



Code	INSTALLATION PRODUCTS
	Hammer drill
BHDSXXXX	Concrete Drill bits
MOBOMBA	Blow pump
MORCEPKIT	Cleaning Brush
EXHBMXX	Manual expansion tool for drop in anchors
	Torque wrench
	Hexagonal socket

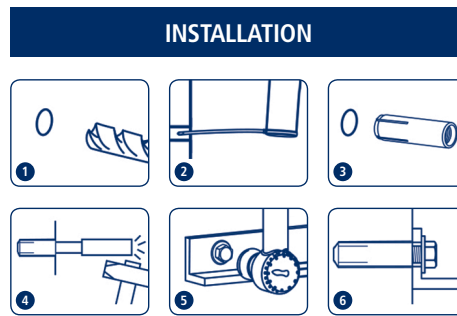

Resistances in C12/15 and from C20/25 to C50/60 concrete for an isolated anchor, without effects of edge distance or spacing

Characteristic Resistance F_{Rk}								
ALL DIRECTIONS LOAD								
Metric			M6	M8	M10	M12	M16	M20
F_{Rk}	Concrete C12/15	[kN]	1,5	3,0	4,0	6,0	9,0	16,0
	Concrete C20/25 to C50/60		2,0	3,0	5,0	7,5	12,0	20,0

Design Resistance F_{Rd}								
ALL DIRECTIONS LOAD								
Metric			M6	M8	M10	M12	M16	M20
F_{Rd}	Concrete C12/15	[kN]	0,8	1,7	1,9	2,9	4,3	7,6
	Concrete C20/25 to C50/60		1,1	1,7	2,4	3,6	5,7	9,5

Maximum Loads Recommended F_{rec}								
ALL DIRECTIONS LOAD								
Metric			M6	M8	M10	M12	M16	M20
F_{rec}	Concrete C12/15	[kN]	0,6	1,2	1,4	2,0	3,1	5,4
	Concrete C20/25 to C50/60		0,8	1,2	1,7	2,6	4,1	6,8

Simplified calculation method

European Technical Assessment ETA 14/0068

Simplified version of the calculation method according to ETAG 001, annex C. Resistance is calculated according to the data shown in assessment ETA 14/0068.

- Influence of concrete strength.
- Influence of edge distance.
- Influence of spacing between anchors.
- Influence of reinforcements.
- Valid for a group of two anchors.

The calculation method is based on the following simplification: **Different loads do not act on individual anchors, without eccentricity.**



INDEXcal

For a more precise calculation and to take more constructive provisions into account, INDEX Fixing Systems is developing a calculation software for multiple use for nonstructural applications in concrete.



HE-HO

ALL LOAD DIRECTIONS

• Design resistance for all load directions: $F_{Rd} = F_{Rd}^o \cdot \Psi_s \cdot \Psi_c \cdot \Psi_{re}$

Design resistance for all load directions							
		F_{Rd}					
Metric		M6	M8	M10	M12	M16	M20
F_{Rd}^o	Concrete C12/15	0,8	1,7	2,2	3,3	5,0	8,9
	Concrete C20/25 to C50/60	1,1	1,7	2,8	4,2	6,7	11,1

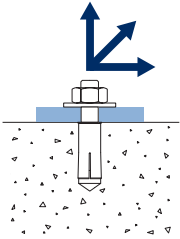

Coefficients of influence

Influence of reinforcements $\Psi_{re,N}$						
	M6	M8	M10	M12	M16	M20
$\Psi_{re,N}$	0,625	0,650	0,700	0,750	0,825	0,900

*This factor only applies for a high density of reinforcements. If in the area of the anchor there are reinforcements with a distancing of ≥ 150 mm (any diameter) or with a diameter ≤ 10 mm and a distancing of ≥ 100 mm, a $f_{re,N} = 1$ factor may be applied.

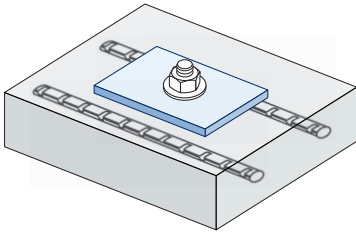

$$\Psi_{re,N} = 0,5 + \frac{h_{ef}}{200} \leq 1$$

Influence of spacing (concrete cone) $\psi_{s,N}$

s [mm]	HE-HO					
	M6	M8	M10	M12	M16	M20
60	0,70	0,67				
70	0,73	0,69				
80	0,77	0,72	0,67			
90	0,80	0,75	0,69			
100	0,83	0,78	0,71	0,67		
110	0,87	0,81	0,73	0,68		
120	0,90	0,83	0,75	0,70		
130	0,93	0,86	0,77	0,72	0,67	
140	0,97	0,89	0,79	0,73	0,68	
150	1,00	0,92	0,81	0,75	0,69	
160		0,94	0,83	0,77	0,71	0,67
170		0,97	0,85	0,78	0,72	0,68
180		1,00	0,88	0,80	0,73	0,69
190			0,90	0,82	0,74	0,70
200			0,92	0,83	0,76	0,71
210			0,94	0,85	0,77	0,72
220			0,96	0,87	0,78	0,73
230			0,98	0,88	0,79	0,74
240			1,00	0,90	0,81	0,75
250				0,92	0,82	0,76
260				0,93	0,83	0,77
270				0,95	0,85	0,78
280				0,97	0,86	0,79
290				0,98	0,87	0,80
300				1,00	0,88	0,81
310					0,90	0,82
320					0,91	0,83
330					0,92	0,84
340					0,94	0,85
350					0,95	0,86
360					0,96	0,88
370					0,97	0,89
380					0,99	0,90
390					1,00	0,91
400						0,92
410						0,93
420						0,94
430						0,95
440						0,96
450						0,97
460						0,98
470						0,99
480						1,00

HE-HO

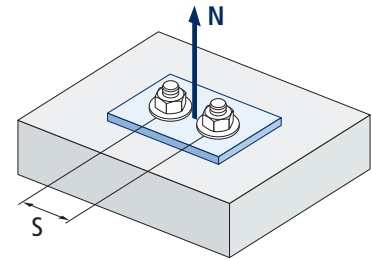

$$\psi_s = 0,5 + \frac{s}{2 \cdot s_{cr}} \leq 1$$

Value without reduction = 1



HE-HO

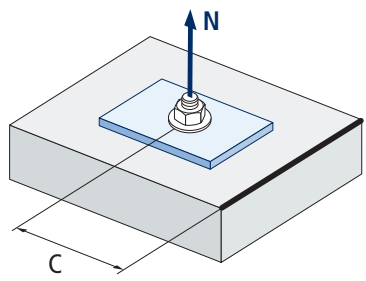

$$\psi_c = 0,35 + \frac{0,5 \cdot c}{C_{cr}} + \frac{0,15 \cdot c^2}{C_{cr}^2} \leq 1$$

Influence of concrete edge distance (concrete cone) $\psi_{c,N}$						
s [mm]	HE-HO					
	M6	M8	M10	M12	M16	M20
60	Invalid value					
65						
70						
75						
80						
85						
90						
95						
100						
105						
110						
115						
120						
125						
130						
135						
140	1,00*					
145						
150						
155						
160						
165						
170						
175	1,00*					
180						
185						
190						
195						
200						
205						
210						
215						
220						
225						
230	1,00*					
235						
240						
250						
260						
270						
280	1,00*					

*installation below the minimum concrete edge distance is not allowed



HE-HO

FIRE RESISTANCE

Characteristic Resistance*						
	TENSION					
	M6	M8	M10	M12	M16	M20
RF30	-	0,4	0,9	1,7	3,1	4,9
RF60	-	0,3	0,8	1,3	2,4	3,7
RF90	-	0,3	0,6	1,1	2	3,2
RF120	-	0,2	0,5	0,8	1,6	2,5

*The safety factor for design resistance under fire exposure is $\gamma_{M,fi}=1$ (in absence of other national regulations). As a result the Characteristic Resistance is the same as Design Resistance.

Maximum Load Recommended						
	TENSION					
	M6	M8	M10	M12	M16	M20
RF30	-	0,3	0,6	1,2	2,2	3,5
RF60	-	0,2	0,6	0,9	1,7	2,6
RF90	-	0,2	0,4	0,8	1,4	2,3
RF120	-	0,1	0,4	0,6	1,1	1,8

RANGE

Code	Size	Length		
HEHOM06	M6 x 25 Ø8	25	100	4.000
HEHOM08	M8 x 30 Ø10	30	100	2.200
HEHOM10	M10 x 40 Ø12	40	50	1.000
HEHOM12	M12 x 50 Ø15	50	50	600
HEHOM16	M16 x 65 Ø20	65	25	250
HEHOM20	M20 x 80 Ø25	80	25	100
• HEHOM12D*	M12 x 50 Ø12	50	50	600

• Non assessed sizes. Resistance values and installation data are not applicable to these references. For further information, please contact Technical Department.



*Designed for fastening diamond cutting equipment

EXP



Manual expansion tool
for drop-in anchors



Code	Size		
EXHBM06	M6 x 120	1	10
EXHBM08	M8 x 120	1	10
EXHBM10	M10 x 120	1	10
EXHBM12	M12 x 130	1	10
EXHBM16	M16 x 145	1	10
EXHBM20	M20 x 155	1	10

