



DAFA AirStop System[®] Installation instructions



Preface

Build using a vapor barrier - build with care

DAFA AirStop System is an effective and reliable sealing system for vapor barriers. A product series that supports sustainable construction and reduces energy consumption, to the benefit of the environment.

These instructions provide a thorough overview of where DAFA AirStop System can be used, and how it is installed.

Everyone involved in installing DAFA's products must do so in accordance with the applicable installation instructions, including recommendations, in order for DAFA's functional and product warranty to apply.



Vapor barrier foils

- ProFoil, EcoFoil, DiFoil, UniFoil and HiFoil

Preparation

DAFA vapor barrier foils can be installed at temperatures above 5 °C. Before installing the vapor barrier, the structure must be braced and secured so that the foil, tape, joins, etc. are not exposed to unnecessary strain. Surfaces on which tape or foil adhesive are to be installed must be dry and free of dust. Ensure there are no damp or wet materials or materials with mold in the structure.

The installer is responsible in all cases for ensuring the vapor barrier is airtight, in line with applicable regulations and recommendations.

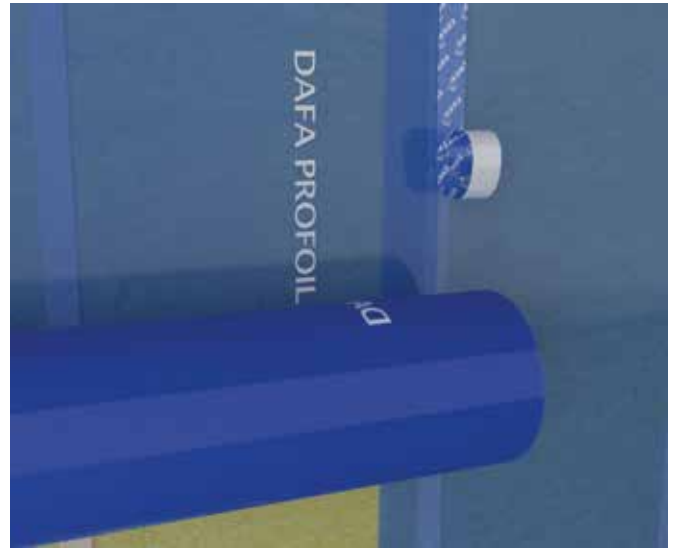

DAFA foils must always be installed so that the side with text is facing the heated section. Joins, penetrations and connections must always have a firm underlayment.

Installation

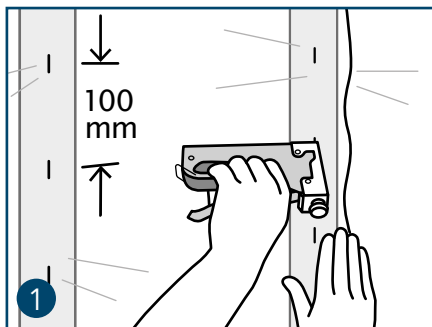

Affix the foil to a wooden underlayment using staples, placed longitudinally in a straight line with 100 mm spacing. Joins, penetrations and connections must always have a firm underlayment.

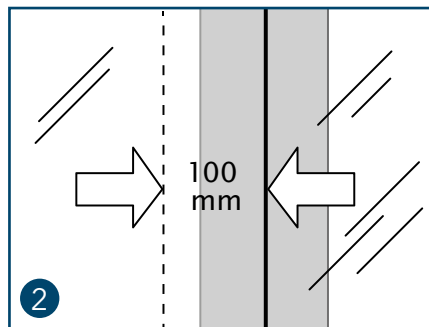

Make joins or connections with at least 100 mm overlap and a firm underlayment. It is important that the overlap does not wrinkle or fold.

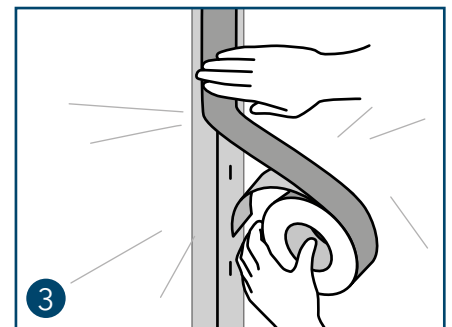

Seal staples and joins on the vapor barrier using DAFA tape. Center the tape over the joint and apply pressure to ensure maximum adhesion.

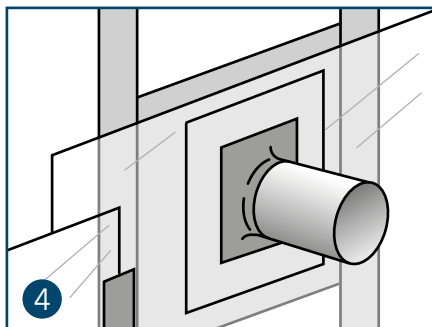

Joins, penetrations and connections must always have a firm underlayment, such as formwork panels or 15 mm plywood sheeting.

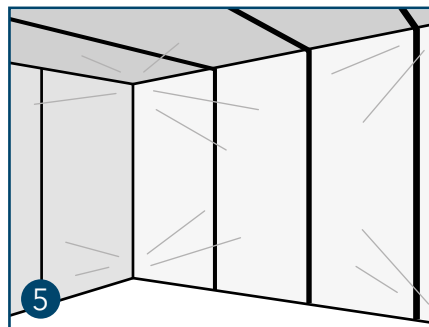

After installation, the vapor barrier must be flat and taut. It is important that the vapor barrier is not exposed to excessive tension in corners and at joins, to avoid unnecessary strain.

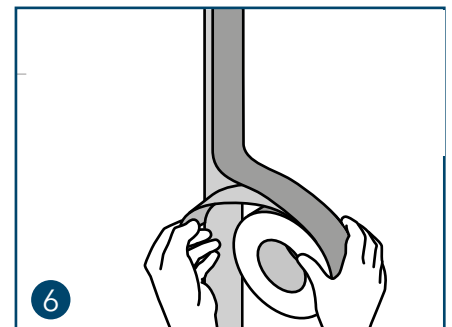

On steel surfaces, use DAFA double-sided tape.

Vapor barrier foil with reinforcing mesh - DAFA ExFoil™

Preparation

DAFA vapor barrier foils can be installed at temperatures above 5 °C. Before installing the vapor barrier, the structure must be braced and secured so that the foil, tape, joints, etc. are not exposed to unnecessary strain. Surfaces on which tape or foil adhesive are to be installed must be dry and free of dust. Ensure there are no damp or wet materials or materials with mold in the structure. DAFA ExFoil must always be installed so that the side with text is facing the heated section.

Tape joints for ExFoil vapor barrier

- DAFA Hi-tack gray tape, with a minimum of 100 mm overlap, must be used when joining longitudinal and transverse joints
- Firmly affix the tape to the foil using a plastic spatula or pressure roller
- DAFA ExFoil can be installed across or along the rafters

Installation across the structure:

- DAFA ExFoil may be installed without a firm underlayment on horizontal ceilings, where the insulation is less than 450 mm thick, provided that the insulation is installed according to the manufacturers' current installation instructions, so as to minimize mechanical load
- For horizontal ceilings with more than 450 mm insulation, tape joints must have a firm underlayment or the tape joint must be supported, for example using a formwork panel
- Tape joints for sloping walls or ceilings with a slope of more than 45 degrees can be made without a firm underlayment
- When installing on walls, tape joints do not require a firm underlayment
- The unsupported span must not exceed 100 cm center-to-center. For larger spans, the tape joint must be supported, for example using a formwork panel
- In all cases where loose or blown-in insulation is used, there must be a firm underlayment directly under the overlap, so that the tape joint is not subjected to mechanical load.

Installation along the structure:

- When installed on walls and ceilings, vapor barrier joints must have a firm underlayment
- If it is not possible to make joints over a firm underlayment, please refer to the section on "Installation across the structure"

Use a firm underlayment for complicated sealing and joints, such as around beams

The installer is responsible in all cases for ensuring the vapor barrier is airtight, in line with applicable regulations and recommendations.



Installation/staples

- Affix staples at 10 cm intervals
- The 10 x 10 cm grid lines make it easy to observe the correct interval for staples
- Affix staples using a hand or air gun
- Staples do not have to be taped afterwards when the distance between them does not exceed 10 cm
- The airtightness *may* be increased if staples are taped.
- Ensure that the staples do not damage the vapor barrier

Installing Hi-tack pipe collars/cable collars

For pipe and cable penetrations and connections, use DAFA Hi-tack pipe and cable collars. These must have a firm underlayment, such as formwork panels or 15 mm plywood.

Accessories for DAFA ExFoil vapor barrier

- [DAFA Hi-tack vapor barrier tape, gray or lime](#)
- [DAFA Hi-tack pipe collars](#)
- [DAFA Hi-tack cable collar](#)
- [DAFA ExFoil lining foil](#)
- [DAFA ExFoil sill foil](#)

Repairing the vapor barrier

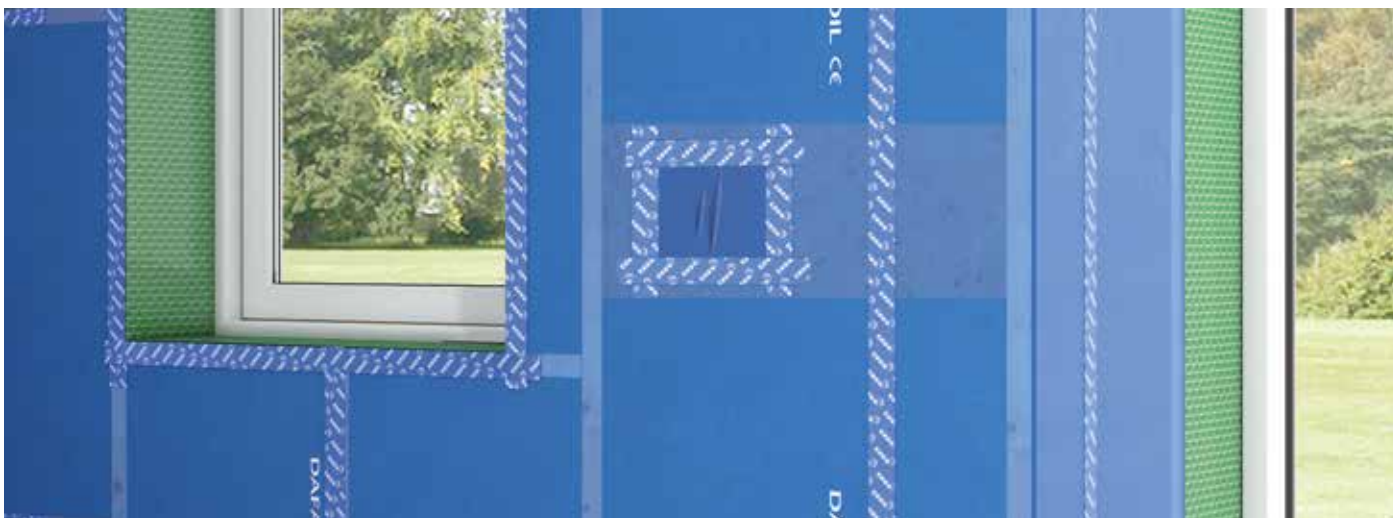

If you perform repairs such as painting, replacing individual roof tiles or render repairs, there are no special requirements in the Danish Building Regulations. If the existing vapor barrier is broken, it must be repaired to the same condition as before.

Repairing vapor barrier foils

Repair small holes less than 2 cm² and tears less than 10 cm in length using DAFA vapor barrier tape. For larger holes or tears, install a piece of vapor barrier foil of the same type as the damaged foil. Cut the foil to size, leaving at least a 10 cm overlap, and ensure there is a firm underlayment under the join. Use DAFA vapor barrier tape to affix the join.

Repairing other components

Damaged accessories such as collars, corners and lining foils must be discarded and disposed of. Do not repair or re-use these.

Important

All penetrations, vapor barrier joins and connections must have a solid, even and dust-free underlay to ensure they are airtight and durable. Join vapor barriers with at least 100 mm overlap. Affix using tape, adhesive, butyl tape, etc. and press firmly, for example with a nylon roller, after installation.

Always ensure that the vapor barrier is affixed, so that no damage occurs when exposed to wind pressure, such as during air tightness testing. Make joins or connections with at least 100 mm overlap. It is important that the overlap does not wrinkle or fold.

Seal installation staples and joins on the vapor barrier using DAFA tape. Center the tape over the join and apply pressure to ensure maximum adhesion. Before applying, the surfaces must be clean, dry and free of dirt and dust. After installation, the vapor barrier must be flat and taut. It is important that the vapor barrier is not exposed to excessive tension in corners and at joins, to avoid unnecessary strain.

DAFA foil adhesive

DAFA foil adhesive is used for airtight joins on porous and absorbent surfaces such as brick, concrete, aerated concrete or dry woodwork. DAFA foil adhesive is part of the DAFA AirStop System.

Preparation

The surface must be solid, dry and free of dust and oil. Important: The surface must be absorbent, such as render, concrete or untreated wood.

Use DAFA universal or water-based primer where sufficient adhesion to the surface cannot be achieved with DAFA foil adhesive.

DAFA foil adhesive smooths out uneven surfaces and can be used without clamping strips.



DAFA foil adhesive

Installation

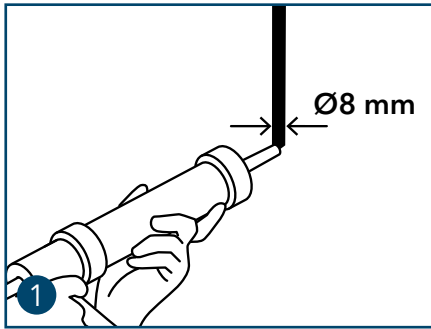

Apply the adhesive in a bead at least 8 mm in diameter.

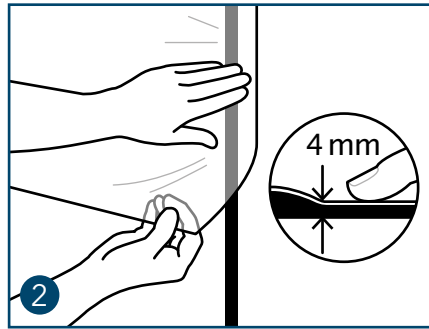

Then immediately affix the foil gently to the wet adhesive bead (do not flatten it - the bead must remain at least 4 mm thick). Remember to use a strain-relief fold - or press the vapor/moisture barrier into place on the dry adhesive bead.

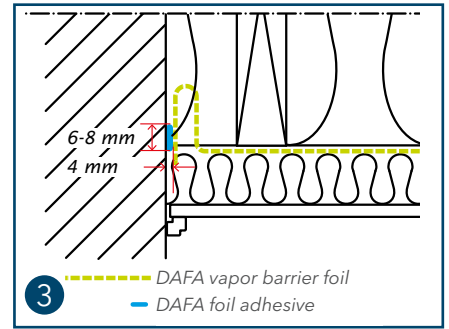

Relieve strain on the joint by folding the foil just before the join.

DAFA Multi Sealing™

DAFA Multi Sealing is used to seal where the vapor barrier is penetrated by wood, steel beams, etc. DAFA Multi Sealing is an extruded butyl sealing tape coated with stretch film. It is extremely flexible and therefore very useful for unusual sealing applications.

Preparation

Before installing the vapor barrier, a solid surface must be established on which the vapor barrier and DAFA Multi Sealing can be installed with airtight joints. The best surface to use is 15 mm plywood. Trim the vapor barrier in the corner where the element penetrates the foil. It is important that the foil does not wrinkle or fold. The vapor barrier must be clean, dry and free of dirt and dust.

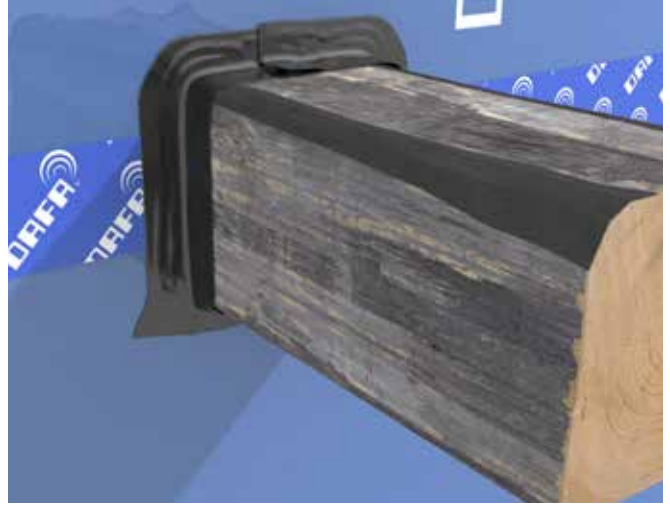

DAFA Multi Sealing™

Installation

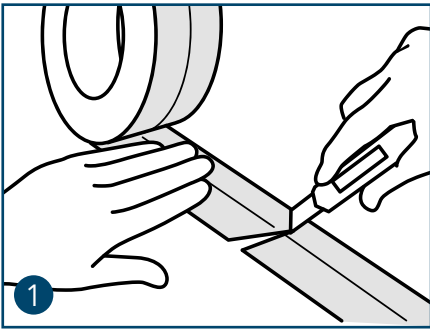

1 Cut off a suitable piece of DAFA Multi Sealing.

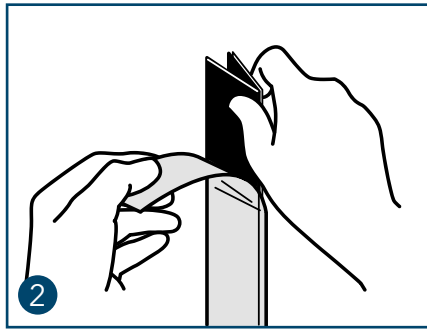

2 Remove the cover paper.

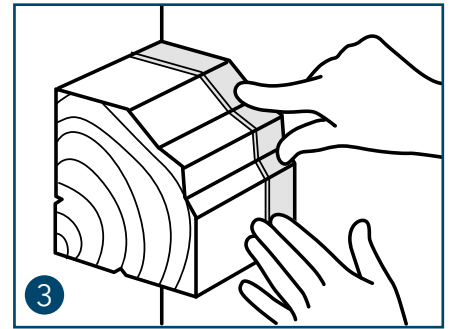

3 Affix the DAFA Multi Sealing to the element. Remove half of the paper.

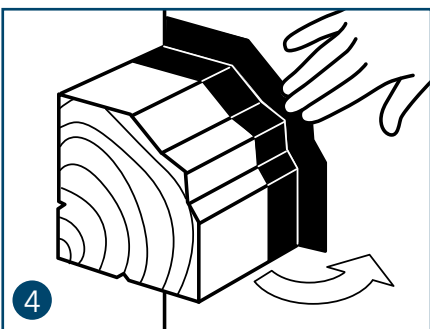

4 Unfold the DAFA Multi Sealing and affix to the foil. Press the DAFA Multi Sealing firmly against the element and the foil to ensure an optimum seal.

NB: Damaged accessories should be discarded and disposed of. Do not repair or recycle these.

DAFA vapor barrier tape

- for PE vapor barriers and vapor diffusion retarder

(Used for: ProFoil, EcoFoil, UniFoil and DiFoil)



DAFA vapor barrier tape - blue

Ideal for longitudinal and transverse joints. Trim to length easily without the use of tools.



DAFA vapor barrier tape - green

Ideal for pipe penetrations. Flexible and stretchable.

- for moisture-adaptive foil and performance foil

(Used for: HiFoil and ExFoil)

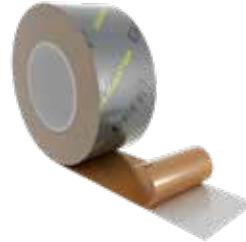

DAFA Hi-tack® tape - gray

Ideal for longitudinal and transverse joints. Trim to length easily without the use of tools.



DAFA Hi-tack® tape - lime green

Ideal for pipe penetrations. Flexible and stretchable.

- for steel structures



DAFA double-sided vapor barrier tape

For taping steel structures. Provides full adhesion with overlap.



DAFA foil spatula

When you tape your joints, remember to massage the tape into the vapor barrier using a spatula.

If you do not use the spatula, about 30-40% of the tape will not be firmly stuck to the surface, and there is a risk it may fall off after 6-10 years.

Installation

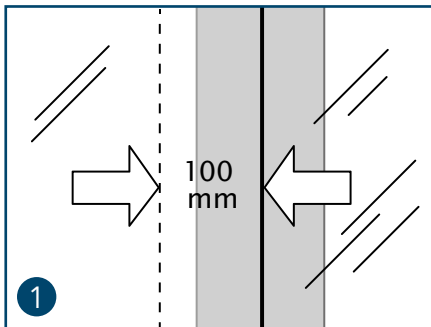

1 Make the foil joints with 100 mm overlap.

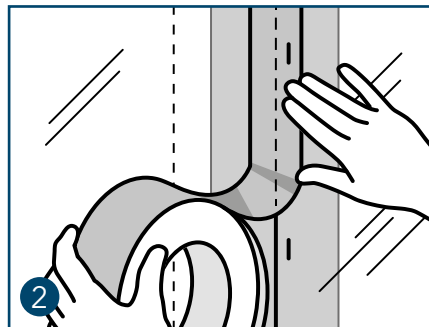

2 Place the tape directly over the joint.

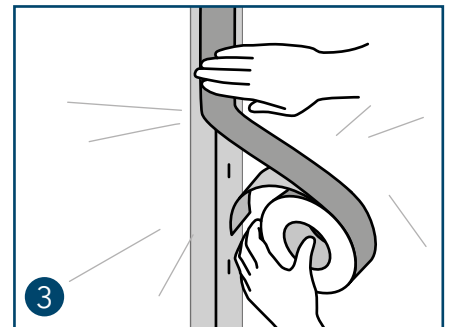

3 During installation, press all tapes evenly against the joint, and always against a firm underlayment. If necessary, use DAFA's foil spatula.

Important!

DAFA vapor barrier tape is a strongly adhesive tape which should only be used in permanent applications, as the tape cannot be removed from the surface again.

DAFA PE lining foil

DAFA PE lining foil is used to seal internally around window and door apertures using a single piece. Lining foil can be used with wooden frames. Adhesion strength should always be tested before installation.

Preparation

The lining foil comes with tape for installation on the outer side of the frame. Attach it to the frame before fitting the window. Clean the outside edge of the frame. It must be clean, dry and free of dirt and dust before affixing the lining foil.

- installation on light partition walls

In wall structures with a vapor barrier, use green DAFA PE lining foil. Affix the foil to the surface in the aperture and bind to the vapor barrier. Joins must be on a firm underlayment with at least 100 mm overlap.

- installation on concrete walls

In structures with no vapor barrier, including concrete walls etc., use blue DAFA PE lining foil. NB: Concrete must always be vacuum cleaned. If adhesion strength is in doubt, seal using DAFA water-based or universal primer. Affix the foil to the wall using the butyl tape attached to the foil and press firmly onto the surface. We recommend pressing the join using a DAFA foil spatula or a similar tool.

Exterior and interior sealing for windows and doors

DAFA Duo Foil lining foil is used for exterior and interior sealing for windows and doors. The foil has a variable Sd value ranging from 0.21 m to 15 m, making it useful in structures with varying moisture impacts.



Green lining foil

Used on lightweight partition walls together with DAFA corners.

Blue lining foil

Used for heavy structures.



Duo Foil lining foil

Used for structures with variable moisture impacts. Typically used with DAFA Hi-Foil vapor barrier.

Installation

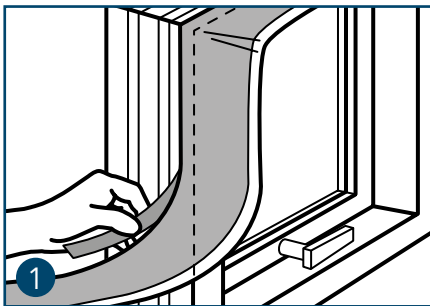

1 Run the foil around the frame in one piece, approx. 30 mm in from the edge, and join with 100 mm overlap.

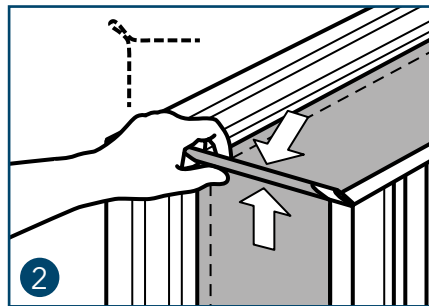

2 Place a 10-20 mm fold at the corners to ensure the lining foil can reach right into the corners of the aperture.

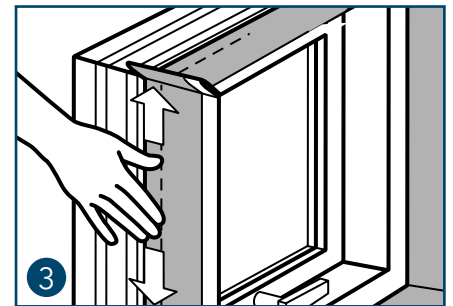

3 It is important that the foil does not wrinkle or fold.

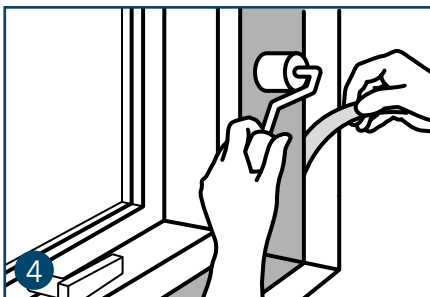

4 After installation, press the adhesive joint to ensure maximum adhesion.

DAFA ExFoil lining foil

DAFA ExFoil lining foil is used to seal internally around window and door apertures using a single piece. Lining foil can be used with wooden frames. Adhesion strength should always be tested before installation.

Preparation

The lining foil comes with tape for installation on the outer side of the frame. Attach it to the frame before fitting the window. Clean the outside edge of the frame. It must be clean, dry and free of dirt and dust before affixing the lining foil.

- installation on light partition walls

Affix the foil with 2 x double adhesive to the surface in the aperture and bind to the vapor barrier. Joins must be on a firm underlayment with at least 100 mm overlap.

- installation on concrete walls

Concrete must always be vacuum cleaned. If adhesion strength is in doubt, seal using DAFA water-based or universal primer.

Affix the foil to the wall using the butyl tape attached to the foil and press firmly onto the surface. We recommend pressing the join using a DAFA foil spatula or a similar tool.



DAFA ExFoil lining foil with 2 x double adhesive (left) for light partition walls, and with double adhesive and butyl (right) for heavy structures.



DAFA ExFoil lining foil is used to seal internally around window and door apertures using a single piece.

Installation

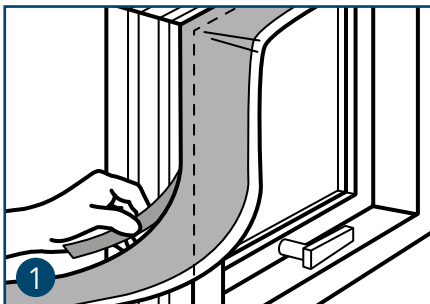

1 Run the foil around the frame in one piece, approx. 30 mm in from the edge, and join with 100 mm overlap.

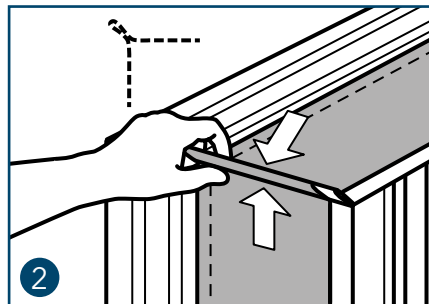

2 Place a 10-20 mm fold at the corners to ensure the lining foil can reach right into the corners of the aperture.

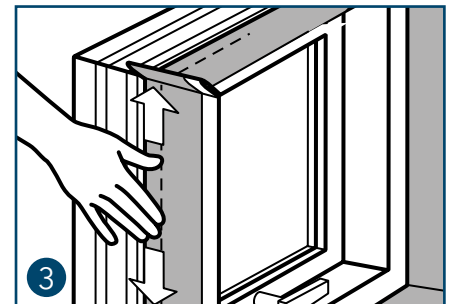

3 It is important that the foil does not wrinkle or fold.

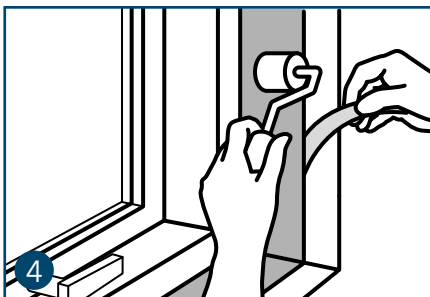

4 After installation, press the adhesive joint to ensure maximum adhesion.

DAFA corners

DAFA corners are specially designed to seal inner and outer corners with an angle of 90°.

Preparation

Before installing the corner, a firm underlayment must be established on which the corner can be attached to the outside of the vapor barrier foil with airtight joints. Before installation, the surfaces must be clean, dry and free of dirt and dust.

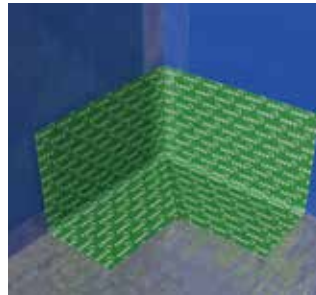

**Green
inside corner**

- for inside corners at the ceiling and floor.



**Blue
outside corner**

- for window and door corners, or inside out for outside corners at the ceiling and floor.

Installation

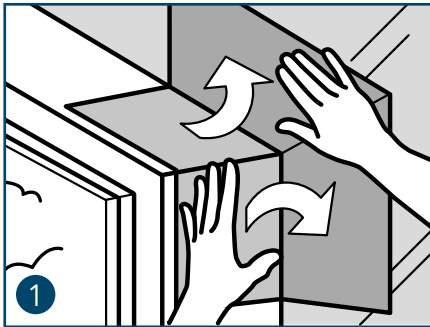

Outside corner: It is important that the overlap does not wrinkle or fold.

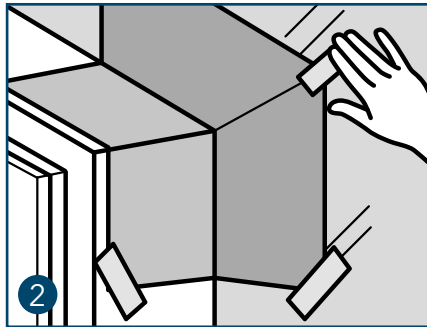

It is a good idea to tape each corner first, as it is then easier to tape the edges.

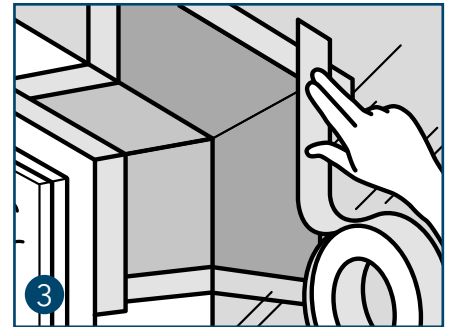

Center the tape over the joint.

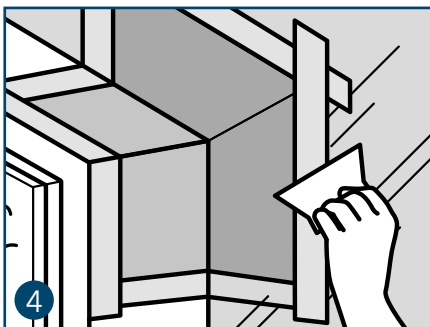

Press the tape using a DAFA foil spatula to ensure maximum adhesion.

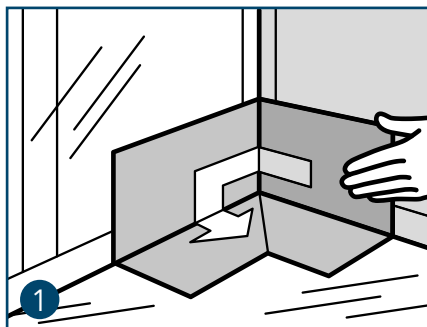

Inside corner: It is important that the overlap does not wrinkle or fold.

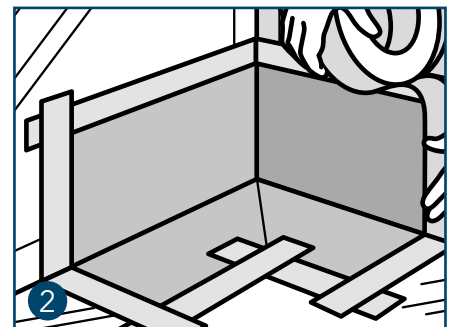

Center the tape over the joint. Alternatively, DAFA foil adhesive can be used.

Important: Damaged accessories should be discarded and disposed of. Do not repair or recycle these.

DAFA ExFoil sill foil

The sill foil forms the seal between the vapor barrier and the backing wall.

Preparation

The surface of the foundation/floor or brick/concrete wall must be cleaned and free of burrs, dust and moisture.



DAFA ExFoil sill foil.
500 mm or 1050 mm x 50 m



DAFA ExFoil sill foil
- at the outer wall



DAFA ExFoil sill foil
- at the inner wall

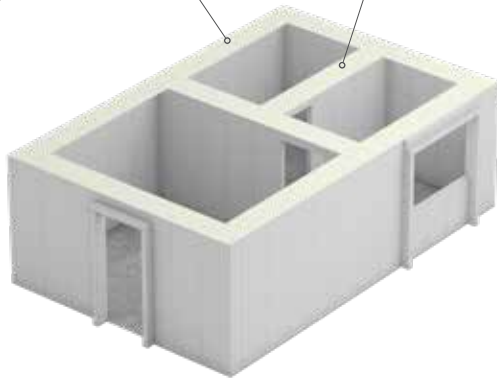

Installing sill foil

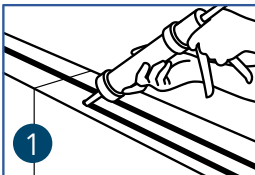

1 To ensure a sealed joint against the underlying structure, lay two beads of DAFA butyl, type 200. The beads must be at least 8 mm thick.

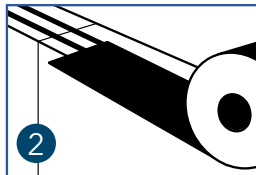

2 If there are large holes or cracks in the structure, these must be sealed using extra sealing compound. The foil can then be installed.

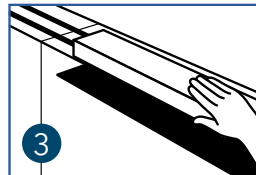

3 It is important to apply pressure to the butyl joint to ensure the best possible seal. When the vapor barrier on the wall has been installed, fold the sill foil and affix to the vapor barrier foil with adhesive.

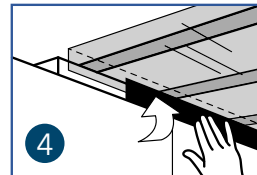

4 We recommend that you establish a firm underlayment under the joint, either by placing the foil so that it can be bonded to the edge of the wall sill, or by erecting extra formwork panels. It is important to apply pressure to the butyl joint to ensure the best possible seal.

Important: Damaged accessories should be discarded and disposed of. They must not be repaired or re-used.

DAFA rafter shoe collar

To ensure a sealed joint, the rafter shoe collar must be supported by a firm underlayment. If the element is larger than the rafter shoe collar (e.g. for collar beams), two collars can be used. It is important that the foil does not wrinkle or fold.



DAFA rafter shoe collar

Installation

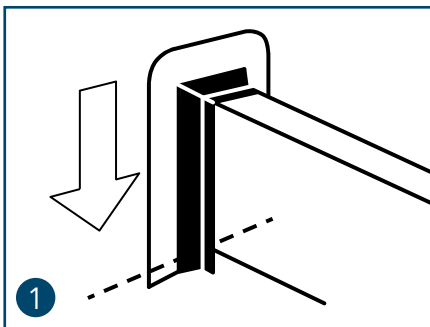

Trim the collar so that it precisely fits the element it is to be installed on.

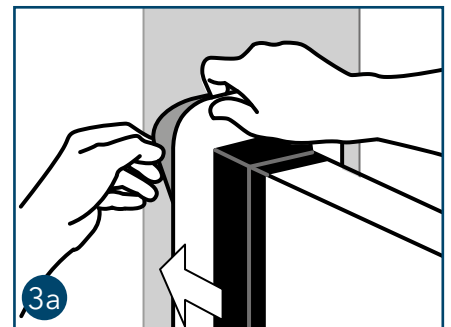
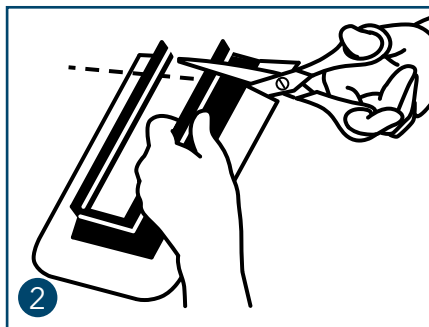

Affix the rafter shoe collar to the underlying surface. Before removing the backing paper, trim the vapor barrier in the corner where the element penetrates the foil. Push the rafter shoe collar firmly against the vapor barrier foil.



Alternatively, remove the backing paper on the outer side of the collar and press the foil firmly onto the rafter shoe collar.

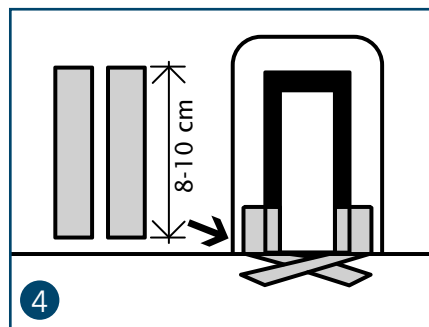

Seal the open end using green DAFA vapor barrier tape. When joining rafter shoe collars, the overlap must be at least 50 mm.

NB: Damaged accessories should be discarded and disposed of. Do not repair or recycle these.

DAFA pipe collars

Preparation

Before installing the pipe collar, a solid surface must be established on which the vapor barrier and pipe collar can be installed with airtight joints. This surface can be made using formwork panels or 15 mm plywood. The pipe must be affixed to the structure. It is important that the foil does not wrinkle or fold.

The pipe collar comes with pre-stamped markings. No cuts may be made other than the pre-stamped ones.

Use DAFA universal or water-based primer where sufficient adhesion to the surface cannot be achieved. We recommend you use primer on absorbent surfaces such as brick, concrete, aerated concrete or dry woodwork.

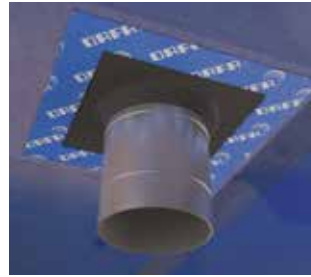

DAFA universal pipe collar for all PE foils and DAFA DiFoil.



DAFA Hi-tack® pipe collars are used for DAFA ExFoil and DAFA HiFoil vapor barriers.

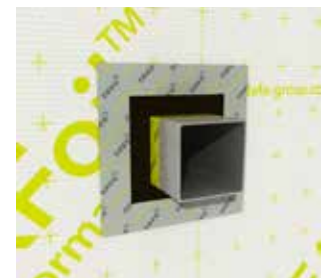
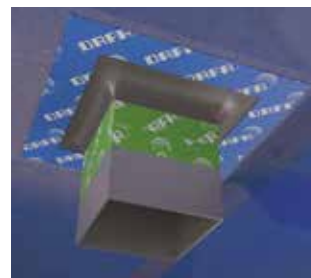

For rectangular pipes, DAFA universal pipe collars must be sealed using green DAFA vapor barrier tape, while DAFA Hi-tack pipe collars must be sealed using lime green Hi-tack tape.

Installing pipe collars

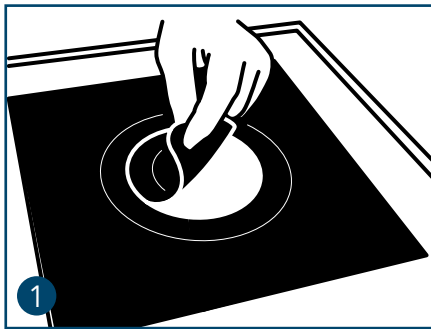

1 Remove the pre-stamped cut-out that matches the penetrating element.

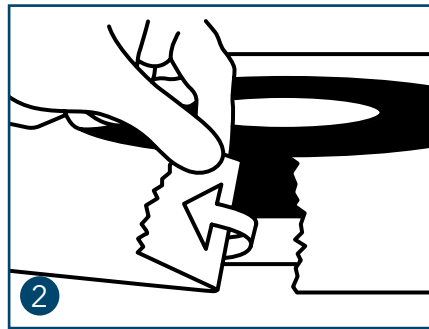

2 Break the backing paper on both sides before pulling the collar onto the element.

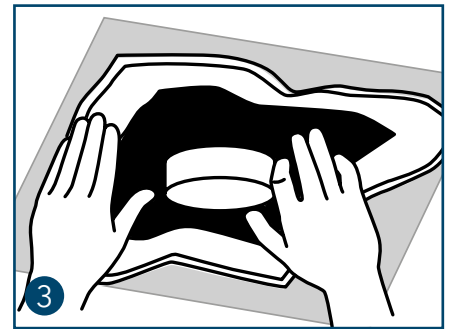

3 Feed the collar over the pipe, as close to the vapor barrier as possible, before removing the backing paper.



4 Remove the paper.



5 Press the collar against the foil in a smooth movement.

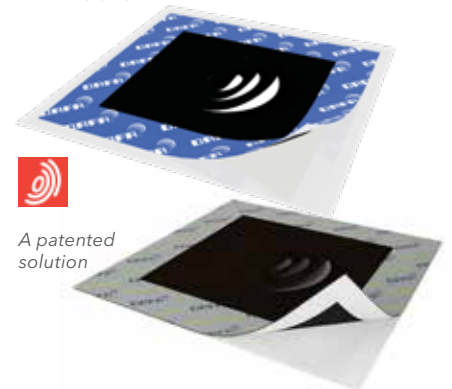

Important: Damaged accessories should be discarded and disposed of. They must not be repaired or re-used.

DAFA pipe collars

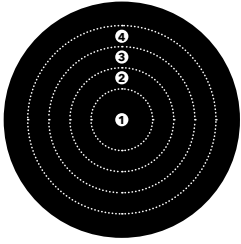

Markings type 260

- 1 Ø12 mm fits to round pipes from Ø15 mm to Ø25 mm
- 2 Ø25 mm fits to round pipes from Ø40 mm to Ø60 mm
- 3 Ø45 mm fits to round pipes from Ø60 mm to Ø90 mm
- 4 Ø70 mm fits to round pipes from Ø90 mm to Ø110 mm

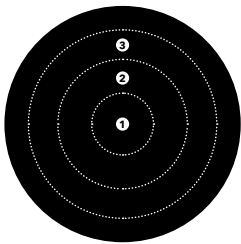

Markings type 345

- 1 Ø60 mm fits to round pipes from Ø80 mm to Ø125 mm
- 2 Ø100 mm fits to round pipes from Ø125 mm to Ø160 mm and to squared pipes 100 mm x 150 mm samt 150 mm x 150 mm
PLEASE NOTE: Rectangular pipes are sealed using DAFA green vapour barrier tape between the pipe and collar.
- 3 Ø135 mm fits to round pipes from Ø160 mm to Ø200 mm

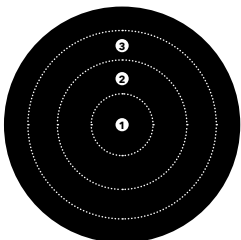

Markings type 520

- 1 Ø150 fits round pipes from Ø200 mm to Ø250 mm
- 2 Ø190 fits round pipes from Ø250 mm to Ø315 mm
- 3 Ø255 fits round pipes from Ø315 mm to Ø400 mm



Patented solutions

With the patenting of DAFA universal pipe and cable collars, we have developed a unique solution to the DAFA AirStop System that adds an extra strong seal to the vapor barrier.



DAFA cable collars

Preparation

Before installing the cable collar, a solid surface must be established on which the vapor barrier and cable collar can be installed with sealed joints. This surface can be made using formwork panels or 15 mm plywood. PL-ceiling boxes or cables must be affixed to the structure. It is important that the foil does not wrinkle or fold. The cable collar comes with pre-stamped markings. You may not make cut-outs for elements that are not pre-stamped.

Use DAFA universal or water-based primer where sufficient adhesion to the surface cannot be achieved. We recommend you use primer on absorbent surfaces such as brick, concrete, aerated concrete or dry woodwork.



DAFA uni. cable collar 195

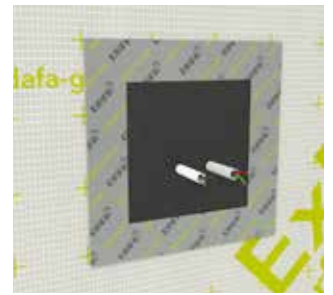

DAFA Hi-tack cable collar 195

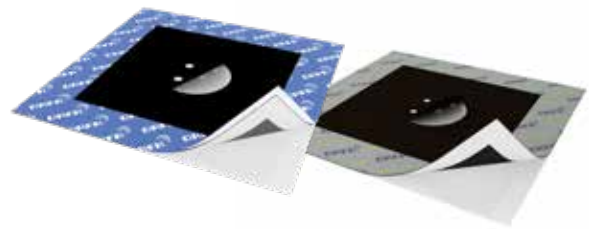

Installing pipe collars



1 Remove the small pre-stamped cut-outs which match the cable conduits.

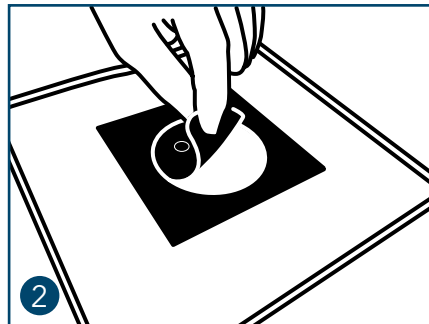

2 In the case of an electrical box, remove the large pre-stamped cut-out.

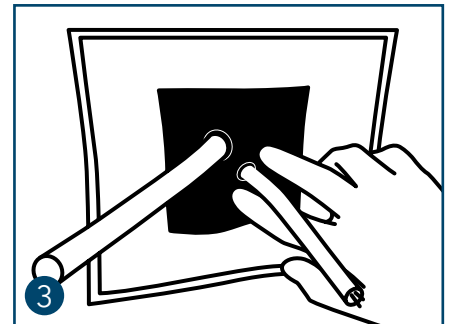

3 Feed the cable collar over the cables or the box.

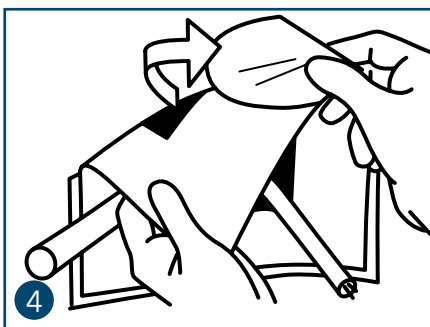

4 Move the backing paper over to the center and then press the cable collar against the vapor barrier.

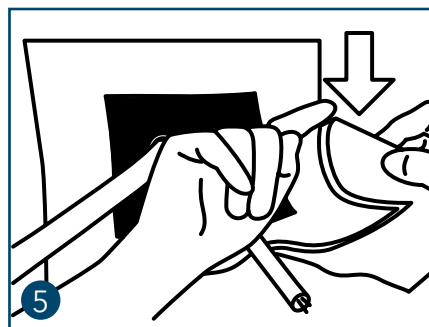

5 Remove the backing paper, while pressing the collar against the foil in a smooth movement.

NB: Damaged accessories should be discarded and disposed of. Do not repair or recycle these.

DAFA cable collars

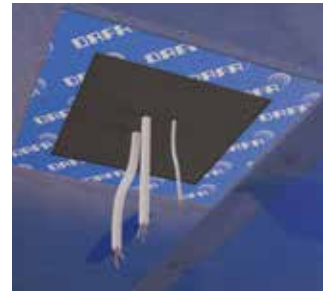
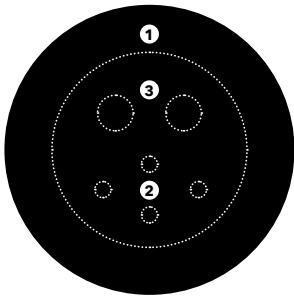

DAFA uni. cable collar 195

DAFA Universal cable collar 195 pre-punched markings

- 1 *Please note: Optimal tightness can be achieved by combining PL boxes with rubber plugs.*
- 2 4 pcs. Ø3 mm fits to Ø7 mm til Ø10 mm cables
- 3 2 pcs. Ø7 mm fits to Ø10 mm to Ø22 mm cables



Patented solutions

With the patenting of DAFA universal pipe and cable collars, we have developed a unique solution to the DAFA AirStop System that adds an extra strong seal to the vapor barrier.



DAFA universal primer

Use DAFA universal primer where sufficient adhesion to the surface cannot be achieved with DAFA vapor barrier tape.

We recommend you use DAFA universal primer on absorbent surfaces such as brick, concrete, aerated concrete or dry woodwork.

Important! Paint, lacquer and plastic surfaces may become discolored. Protect sensitive surfaces, or test these materials before applying.



650 3 e
500 ml.
Color: Transparent
MAL code (1993): 5-3
UN 1950
UFI-CODE: U300-W0XJ-300E-GUY4

Installation

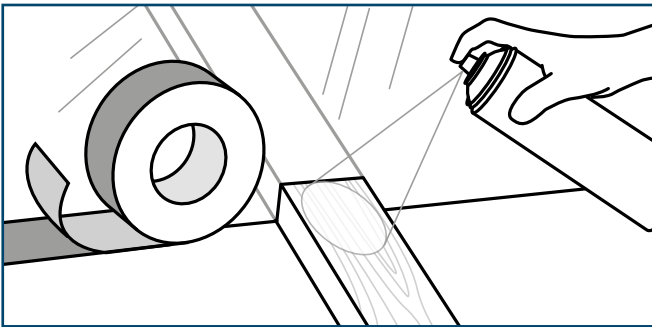

The contact surfaces must be clean and dry and free of grease and oil. Shake the primer thoroughly before use. Apply primer evenly and thoroughly.

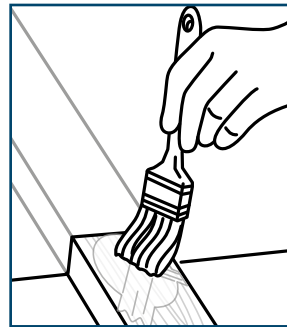

The primer should be brushed onto very porous and absorbent surfaces.

DAFA water-based primer

DAFA water-based primer is used where better adhesion to the underlying surface is desired. It is recommended to apply primer on absorbent surfaces such as cement and gypsum fiber sheets, concrete, stone, brick and sand-lime brick, and fibrous surfaces made of soft fiberboard, wood materials, wood (planed or rough) etc.

Advantages

- Water based and solvent free
- Enhances adhesion
- Changes color when cured
- Can be removed with water before curing
- Good water resistance after curing

Installation

Contact surfaces must be perfectly clean, dry, grease-free and oil-free. Shake the primer thoroughly before use. Apply the primer evenly and thoroughly with a brush or roller.

Before affixing the tape, allow the primer to air dry until it changes color to dark gray.



Installation

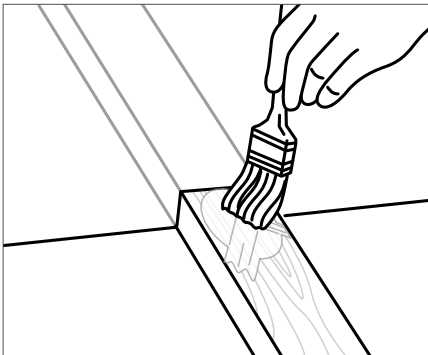

The contact surfaces must be clean and dry and free of grease and oil. DAFA water-based primer should be brushed or rolled onto the underlay.

Handling

Foils

DAFA's vapor barrier foils are supplied on rolls with cardboard center tubes, wrapped in protective film. The rolls must be stored and transported lying down, in such a way that they are not damaged. During storage, the rolls must not be exposed to direct sunlight.

The foils must not be rolled out on floors etc. which could damage them. We recommend that you suspend the roll horizontally and roll out the foil in the air.



Accessories

Tape, pipe and cable collars, rafter shoe collars, brickwork tape, corner foils, etc. are best stored at room temperature.

Foil adhesive must be stored at above 5 °C. Before installation, all materials must be acclimatized, so that they match the temperature in the building in which they are to be installed.





Website

dafa-group.com

You can download information anywhere. Your access to information from DAFA has become even better. Our website has been optimized. This includes making it mobile-phone-friendly, so you can easily search via your mobile phone.

Follow us:

 **LinkedIn**
[linkedin.com/showcase/dafa-building-materials](https://www.linkedin.com/showcase/dafa-building-materials)

 **Facebook**
[@dafa.byg](https://www.facebook.com/dafa.byg)



References

Regarding matters not described in these instructions, please refer to the following sources:

- The Danish Building Regulations: bygningsreglementet.dk
- DS/EN ISO 9972:2015 Thermal performance of buildings - Determination of air permeability of buildings
- SBi Guideline 267 'Småhuse Klimaskærmen'
- SBi Guideline 266 'Indeklima og energi'
- SBi guideline 275 'Tage'
- SBi Guideline 214 'Klimaskærmens lufttæthed'
- SBi Guideline 221 'Efterisolering af etageboliger'
- SBi Guideline 224 'Fugt i bygninger'
- SBi Guideline 225 'Etablering af tagboliger'
- SBi Guideline 226 'Tagboliger - byggeteknik'
- SBi Guideline 239 'Efterisolering af småhuse - energibesparelser og planlægning'
- Byg-erfa paper (99) 10 11 18 - 'Utætheder i klimaskærmen, måling, lokalisering og vurdering'
- Byg-erfa paper (99) 13 12 29 - 'Klimaskærmens tæthed - krav, måling, lufttætning'
- Byg-erfa paper (39) 18 12 12 - 'To dampspærre - ved nybyggeri og renovering'
- Byg-erfa paper (31) 15 11 15 - 'Indvendig efterisolering af ældre ydermure'
- Byg-erfa paper (39) 15 12 28 'Dampspærrematerialer og fugttransport - væg- og loftkonstruktioner'
- Byg-erfa paper (39) 15 12 29 - 'Dampspærre, udførelse og detaljer mod opvarmede rum'
- Byg-erfa paper (37) 15 12 30 - 'Efterisolering af vandrette lofter - 'ventilerede tagrum'
- Byg-erfa paper (39) 15 12 88 - 'Dampspærre i klimaskærmen, fugttransport og materialer'
- Byg-erfa paper (39) 11 11 22 - 'Dampspærresamlinger og tætningsmidler'
- Byg-erfa paper (39) 14 12 11 - 'Indbygning af halogenspots i isolerede loftkonstruktioner'
- Byg-erfa paper (29) 15 05 30 - 'Ydervægge i uopvarmede kortvarigt opvarmede bygninger'
- Byg-erfa paper (29) 03 11 26 - 'Fugtforhold og dampspærre i fryse- og kølehuse, skøjtehallen og andre afkølede rum'
- Byg-erfa paper (27) 06 06 30 - 'Træbaserede tagelementer - styring af fugtforhold fra fabrik til færdigt byggeri'
- Byg-erfa paper (27) 98 05 27 - 'Sommerkondens. Tagkonstruktioner med tagpap eller tagfolie'
- Byg-erfa paper (27) 10 03 22 - 'Varme tage, efterisolering og fugtforhold'
- Byg-erfa paper (21) 05 12 29 - 'Utætte ydervægge ved gulv, under døre og vinduer'
- Byg-erfa paper (13) 04 08 02 - 'Fugtspærre i trægulve og andre fugtfølsomme gulve'
- Byg-erfa paper (99) 16 08 31 - 'Lufttæthed i ældre bygninger - efter renovering og fornyelse'
- www.byggeriogenergi.dk
- DAFA product data sheets: www.dafa-group.com

DAFA AirStop System® - guaranteed

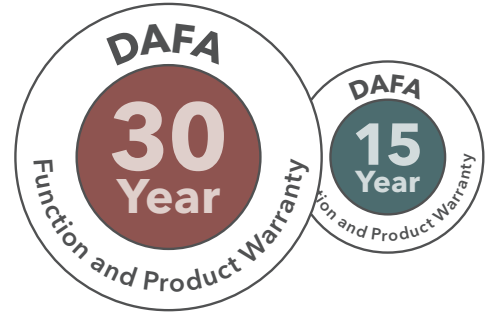

DAFA's function and product warranty provides greater peace of mind

DAFA offers a highly attractive 15-year functional warranty and 30-year product warranty on all products in the DAFA AirStop System range.

The product warranty covers the durability of the product, while the functional warranty ensures that the products fulfil the standards and norms they have been approved under. The warranty will apply in the event that the building envelope fails to fulfil the applicable legal requirements regarding sealing during the warranty period.

Under the warranty, DAFA will bear all costs for the delivery, removal and installation of all the products used in the structure.

This is conditional on the final solution meeting certain requirements, which you can see below:

How to be covered by DAFA's functional and product warranty

It is easy to ensure you are covered by DAFA's 15-year functional warranty and 30-year product warranty. The following factors apply:

Correct installation

DAFA AirStop System products must of course be installed correctly, in accordance with DAFA's installation instructions and recommendations and the local Building Regulation requirements and recommendations.



Complete DAFA AirStop System®

To ensure warranty cover, only products from the DAFA AirStop System may be used for the inner sealing. This means the vapor barrier foils and system accessories such as vapor barrier tape, foil adhesive, lining foil, plinth and sill foil, universal pipe collars and universal cable collars.

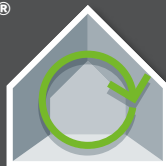

Documentation

You must be able to document which products were purchased and used in a given project. The documentation is therefore the invoices and/or shipping notes covering the purchase of products from the DAFA AirStop System.



Proper planning and design

It is a condition that the planning for a construction project fulfills the applicable rules, including the applicable Danish Building Regulations. This applies to both new construction and renovation projects.



Blower door test

A blower door test is solid proof that a construction project has been completed correctly. If your project is covered by a blower door test requirement, the results of this must be available.





The invisible lines that make wonders happen

At DAFA we are experts in specialized products and total solutions that seal, absorb and protect.

With constant innovation, uncompromising product quality and close collaboration with our partners, we contribute to successful projects in industries where attention to detail is the difference between success and failure.

Our experience covers three quarters of a century with a strong commitment to principles of sustainability in business decisions that create long-term value for our stakeholders.

Our global supply chain means we deliver to any location efficiently on competitive conditions.



Follow us



* Applies to: DAFA A/S, DAFA Sverige AB, DAFA Deutschland GmbH, DAFA Sealing Technology (Tianjin) Co., Ltd., DAFA US Inc., DAFA Polska sp. z o.o.

** Applies to: DAFA A/S, DAFA Sverige AB, DAFA Deutschland GmbH, DAFA Sealing Technology (Tianjin) Co., Ltd., DAFA US Inc.

