

## Product No: 3GBP311230-ADKM625

### ABB IE3 CAST IRON MINING MOTOR 2P 132KW 400VD FOOT MOUNT B3 IP66 ORANGE 3GBP311230-ADKM625

#### FEATURES

- IE3 premium efficiency class according to IEC 60034-30-1; 2014
- Permanent grease lubrication
- 6 terminals for connection with cable lugs (not included)
- Copper stator winding
- Pressure die-cast aluminium rotor winding
- Closed key way, half-key balancing as standard
- Components cast from EN-GJL-200 and EN-GJL-250 grade material for extra strength
- Closable grease ejection port with handle located safely on side of motor



#### General Information

Brand	ABB
Product Type	Mining Motors

#### Technical Attributes

No. of Poles	2
Rated Frequency (Hz)	50
Rated Output Power (kW)	132
Rated Voltage (V)	415Δ/690Y
Speed (RPM)	3000

#### Physical Attributes

Colour	Orange
Mounting Type	B3 Foot Mount

#### Dimensions

Dimensions (mm)	78W x 123H x 137D
Weight (kg)	1596

## Protection & Standards

Degree of Protection

IP66

## Resources

Product catalogue (Flipbook)

[Download from here](#)



## TECHNICAL DRAWING

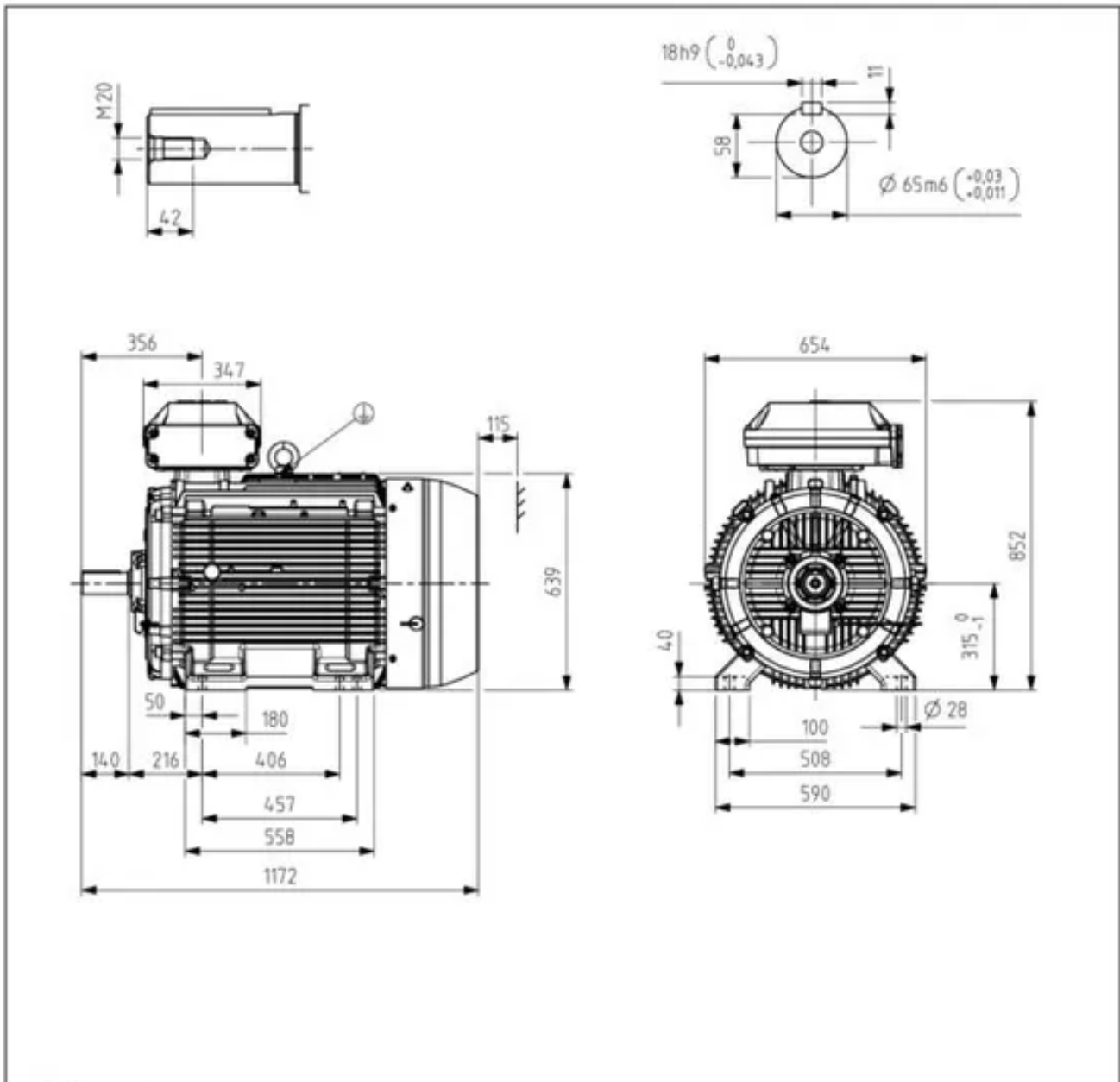

Additional information:

<b>Dimension Print</b>	Motor type: M3BP315 (G/K/L/M) SM_2; B3, V6, B6, B7, B8, V5	Document No: 3GZFS00031-3362 A
	M3GRHP315 (G/K/L/M) SM_2; B3, V6, B6, B7, B8	

Description:  
STANDARD SQUIRREL CAGE MOTOR WITH TERMINAL BOX 370

Unit: Motors and Generators Date: 08-May-2019	Issued by: Penjala, Iikka Approved by: Härmänmaa, Arttu	Replaces: Replaced by:
--	--	---------------------------

<b>ABB</b>	Customer Reference:	
------------	---------------------	--