

Product No: RH2B-ULD-DC24

IDEC PLUG-IN RELAY WITH INDICATOR & DIODE DPDT 24VDC 10A RH2B-ULD-DC24

FEATURES

- Compact power type relays
- Space-saving compact size
- 10A contact capacity
- High switching capacity
- Blade style terminals



General Information

Brand	IDEC
Product Type	Compact
Series	RH

Technical Attributes

Coil Voltage DC (V)	24
Contact Configuration	DPDT
Contact Material	Silver cadmium oxide
Insulation Resistance (MΩ)	100
Minimum Electrical Life	200,000 operations
Minimum Mechanical Life	50,000,000 operations
No. of Poles	2P
Rated Current (A)	10
Relay Type	RH2 2PDT Relay with LED indicator & diode
Suitable Base	SH2B-05C
Terminal Type	Blade

Physical Attributes

Operating Humidity	45 to 85% RH (no condensation)
Operational Temperature Range (°C)	-25 to +40

Dimensions

Weight (g) 37

Resources

Product catalogue (Flipbook)

[Download from here](#)

DIMENSIONS

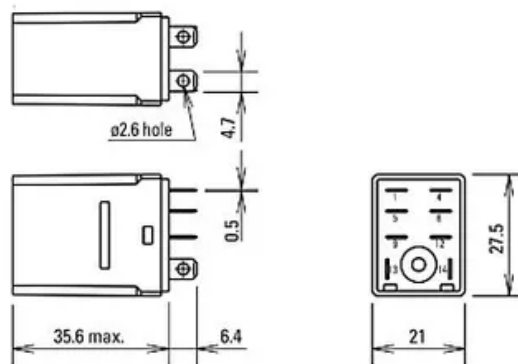

All Dimensions are in "mm"