

## SFM3-63-50-275

**Medium Current Filters**

Novaris SFM filters provide the highest level of protection with the lowest let through voltage. Installation at a main switch board will protect all the connected downstream equipment.

**Percentage Active Display**

A digital display confirms the device rating by displaying the percentage active of the redundant segments. The display indicates segment status and thermal overload.

**Three Stages of Protection**

Novaris surge filters have 2 stages of varistor protection separated by a low pass LC filter. This 3 stage combination reduces the effects of high frequency noise and transients to provide the highest level of protection to sensitive loads.

**All Mode Protection**

Protection is provided for all combinations of lines (L-L, L-N, L-E, N-E) ensuring the maximum level of protection is achieved at all times.

**Active Alarm**



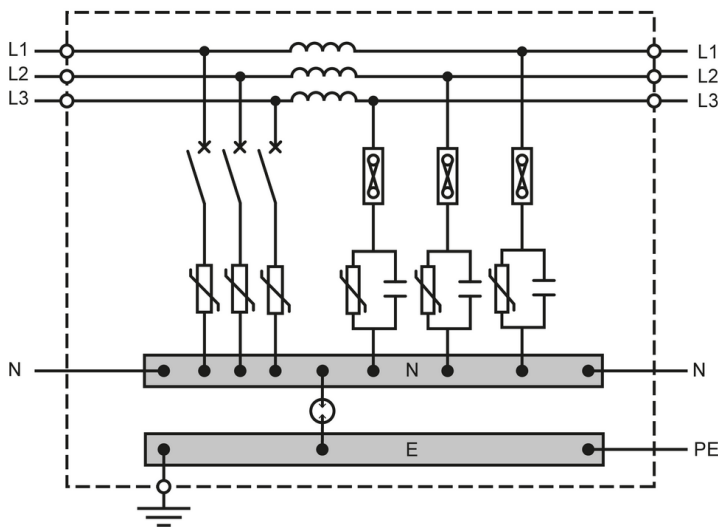
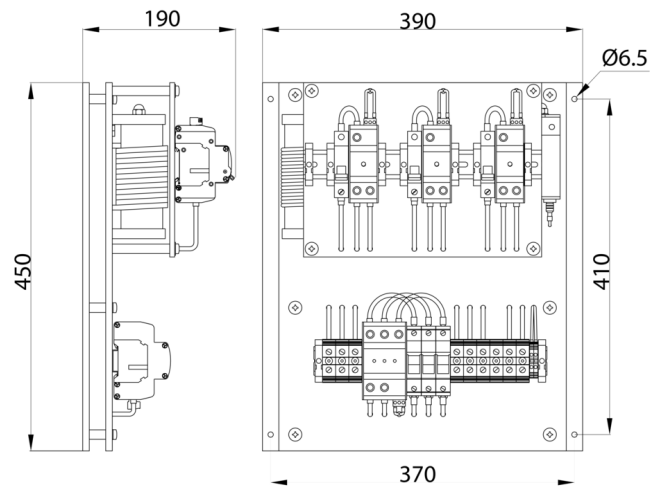

Fail-safe alarm contact allows for remote monitoring.

**Wiring****Dimensions****Standards**

IEC 61643-11:2011  
AS/NZS 1768:2007

SPD connected to low-voltage power systems - Type 1+2  
A.C. power system SPD - Cat C, B



## Electrical Specifications

Connection type		Series
Modes of protection		L-N, L-PE, N-PE
Number of ports		2
Number of phases		3
Location		Indoor
Nominal voltage	$U_0$	230VAC
Short circuit withstand level	$I_{SSCR}$	50kA
Maximum backup fuse		63A
Earth leakage current	$I_{PE}$	<1 $\mu$ A











## Electrical (L-N) Specifications

Maximum load current	$I_L$	63A
Maximum continuous voltage AC	$U_c$	275VAC
Maximum voltage drop (% of $U_0$ )		<1%
3dB frequency @ 50 $\Omega$		420Hz
Maximum discharge current (8/20 $\mu$ s)	$I_{max}$	50kA
Nominal discharge current (8/20 $\mu$ s)	$I_n$	20kA
Lightning impulse current (10/350 $\mu$ s)	$I_{imp}$	6.25kA
Voltage protection level (3kA 8/20 $\mu$ s)	$U_p$	360V
Response time	$t_A$	Instantaneous

## Indication Specifications

Alarm contact current		2A
Display		LED power and thermal failure
Alarm		SPST NC power and thermal failure
Alarm isolation		4kV

## Mechanical Specifications

Minimum operating temperature		-40°C
Maximum operating temperature		70°C
Minimum operating humidity		5%
Maximum operating humidity		95%
Mounting method		Panel
Environmental rating		IP20
Terminal capacity - power		35mm <sup>2</sup>
Terminal screw torque - power		1Nm
Terminal capacity - alarms		2.5mm <sup>2</sup>
Terminal screw torque - alarms		0.5Nm

## Other Specifications

Product Code  SFM3-63-50-275

## Shipping Specifications

Weight		24kg
Customs tariff		85363000, 85363010