

Product No: EMX4i0052BV5C1H

AuCom EMX4i0052BV5C1H SOFT STARTER EMX4i 52A 200-525VAC, CONTROL 110/240VAC

FEATURES

- - Dual motor parameter settings
- - Constant current and current ramp start
- - XLR-8 adaptive control starting/stopping
- - Coast to stop and timed voltage ramp stop
- - Soft trip
- - Configurable multi-language graphical display
- - Quick start application setup for easy commissioning.
- - Emergency run mode
- - Simulation testing (Run, Protection and Signaling)
- - USB port for easy and fast configuration backups and data protection.
- - Real time metering and monitoring
- - Automated pump clean function
- - SCR fail power through operation
- - Scheduled automatic start/stop (Time of day & day of week)
- - Motor voltage and power measurement
- - Automation functions with optional smart card
- - Current Rating: 24A ~ 1250A with Internal Bypass (3 frame sizes)
- - Voltage Ranges: 200 ~ 525 VAC (V5)
- - Protection: IP20/IP00



General Information

Brand	AuCom
Product Type	Advanced Smart - EMX4i

Technical Attributes

Advanced Protection Systems	Motor overload, Excess start time, Over/Undercurrent, Current imbalance, External trip (x2), Motor thermistor, shorted SCR action, Phase loss, Power loss, Over/ Under Voltage, Over/Under Power, RTD, Supply frequency, Network communications, Heatsink over-temperature, Batter/clock failure
Communication Module	DeviceNet, Ethernet/IP, Modbus RTU, Modbus TCP,

Profibus, Profinet

Electromagnetic Capability	EMC Emission (Internally bypassed models) - Class B
Embedded I/O	2 x Fixed, 2 x Programmable digital inputs, 1 x Motor Thermistor input, 1 x Fixed, 2 x programmable relay outputs, 1 x Analogue output
Function	XLR-8 Adaptive Control
Multiple Starting Modes	Constant Current, Current Ramp, Adaptive Control, Kickstart
Multiple Stop Modes	Timed voltage ramp soft stop, Coast to stop, Adaptive control, DC Brake, Soft Brake
Rated Control Supply Voltage AC (V)	110/240
Rated Current - Heavy Duty (A)	34
Rated Current - Light Duty (A)	52
Rated Current - Medium Duty (A)	41
Rated Current - Severe Duty (A)	27
Rated Supply Voltage AC (V)	200 - 525
Short Circuit Capability	Coordination with semiconductor uses (Type 2), Coordination with HRC fuses (Type 1)

Physical Attributes

Operational Temperature Range (°C)	-10 to +60
------------------------------------	------------

Dimensions

Dimensions (mm)	152W x 336H x 231D
Size of Frame	S1

Protection & Standards

Certifications	IEC 60947-4-2
Degree of Protection	IP20
Pollution Degree	3

Resources

Product catalogue (Flipbook)	Download from here
------------------------------	------------------------------------

DIMENSIONS

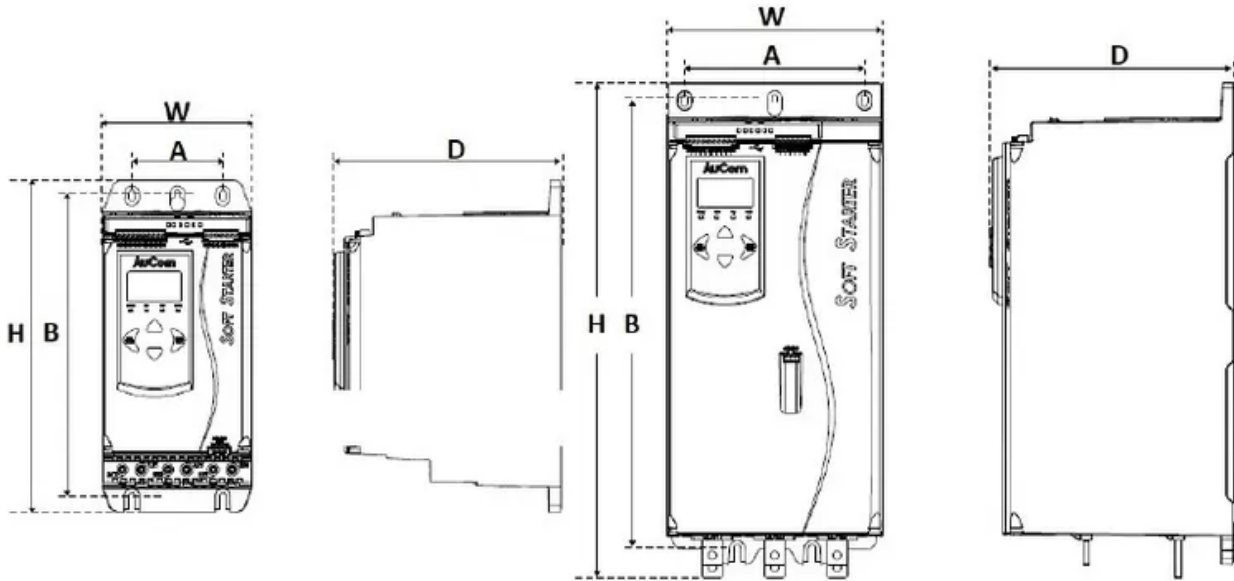

W (mm)	152
H (mm)	336
D (mm)	231
A (mm)	92
B (mm)	231