

Product No: 3GBA312240-ADM

**ABB IE3 CAST IRON MOTOR 4P 160KW 400VD FOOT MOUNT B3
IP66 3GBA312240-ADM**



General Information

Brand	ABB
Product Type	General Performance Motors

Technical Attributes

Rated Power (kW)	160
Rated Voltage (V)	690Y/415D

Protection & Standards

Degree of Protection	IP66
----------------------	------

Resources

Product catalogue (Flipbook)	Download from here
------------------------------	------------------------------------



TECHNICAL DRAWING

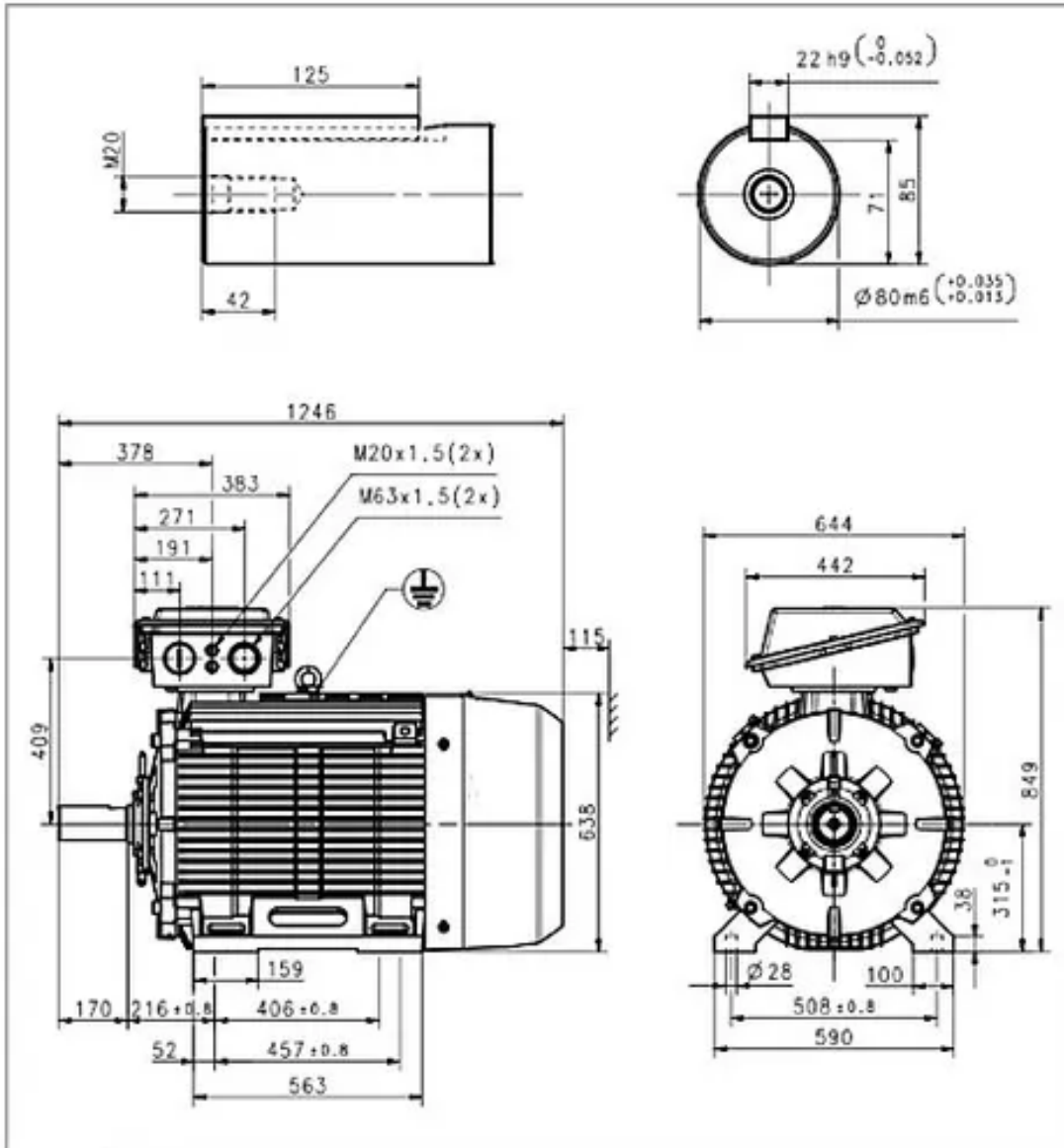

Additional information:

Dimension Print	Motor Type: M2BA/BAX 315SM_4-8 B3 V5 V6 B6 B7 B8.	Document No: 3G2C500031-147 D 13 BA 315 A
	Description: STANDARD SQUIRREL CAGE MOTOR	
Unit: ABB Ltd., Motors and Generators	Issued by: David Wang	Replaces:
Date: 2020-07-21	Approved by: Adam Wang	Replaced by:
ABB Ltd.	Customer Reference:	ABB