

SCAN
LAMPS

FREJA 66302

NO: Skal installeres av auktorisert elektriker.

SE: Installationen ska utföras av person med tillräcklig elkunskap.

FI: Asennus on kiinteä ja sen tulee suorittaa henkilö jolla on riittävä pätevyys ja tuntemus vallitsevista määräyksistä.

EN: Installation should be performed by a qualified electrician.

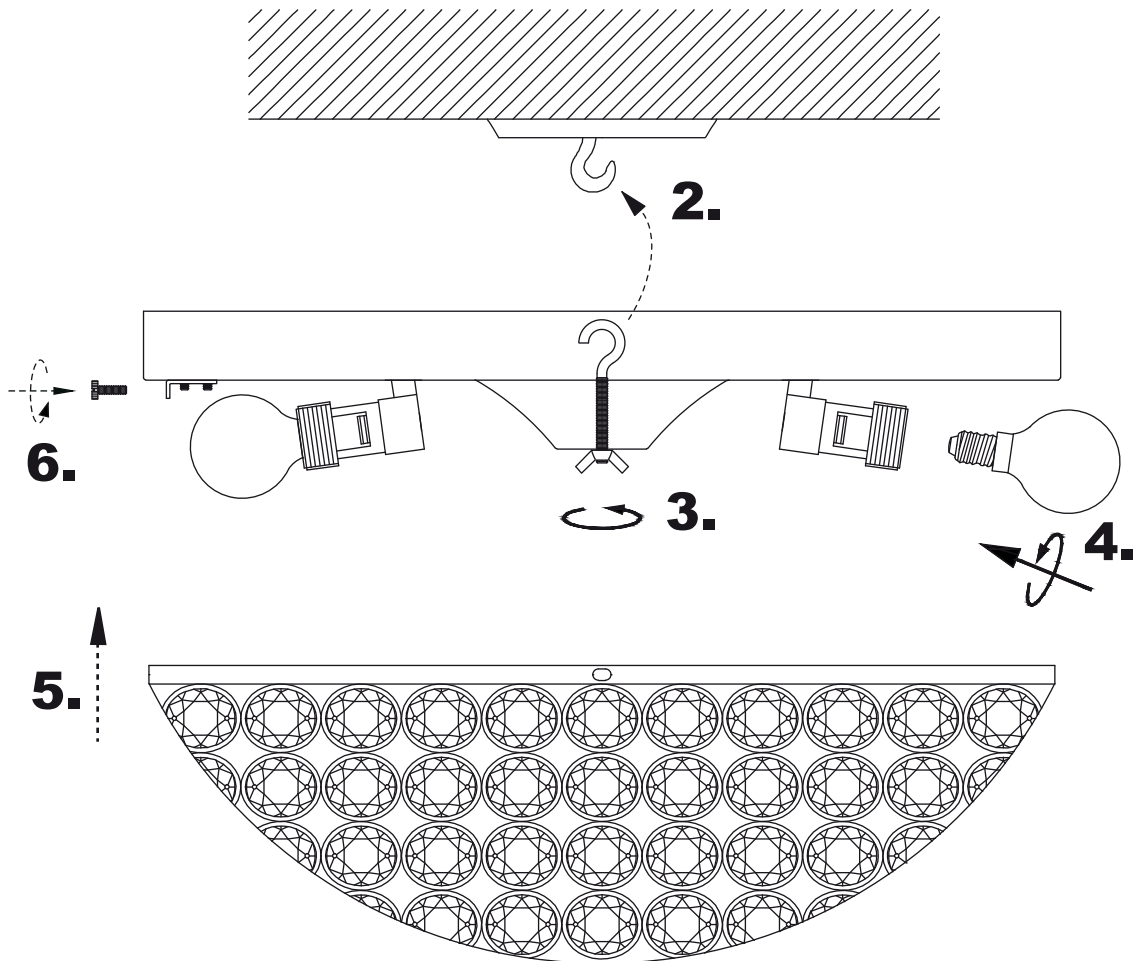

1 alt. A

DCL lamppropp (medföljer ej)
DCL lampestøpsel (ikke inkludert)
DCL lamp plug (not included)

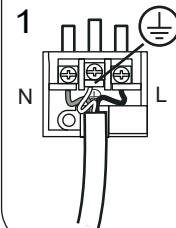
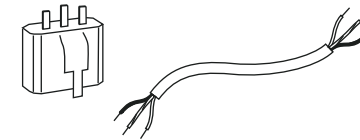

Följ instruktionen till
DCL lampproppen
Følg instruksjonen for
DCL lampestøpselen
Follow the instruction
for the DCL lamp plug

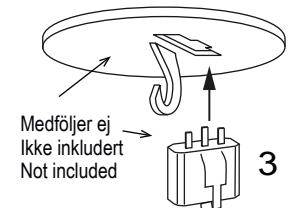

Medföljer ej
Ikke inkludert
Not included

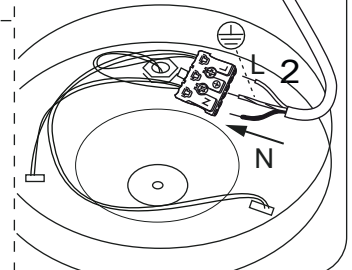

1 alt. B

Lamppropp med kabel (medföljer ej)
Lampestøpsel med ledning (ikke inkludert)
Lamp plug with cable (not included)

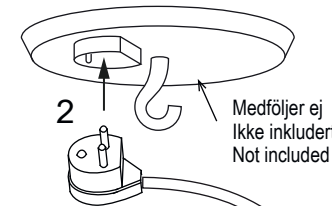

Medföljer ej
Ikke inkludert
Not included

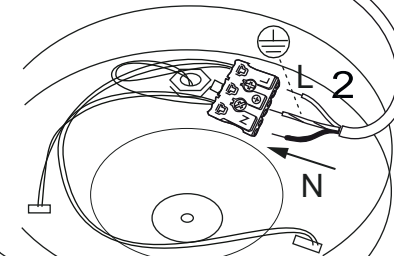

1 alt. C

Inkoppling direkt till strömkablar
Installasjon direkt till strømedning
Installation directly to supply cable

