

## CK 200 A1

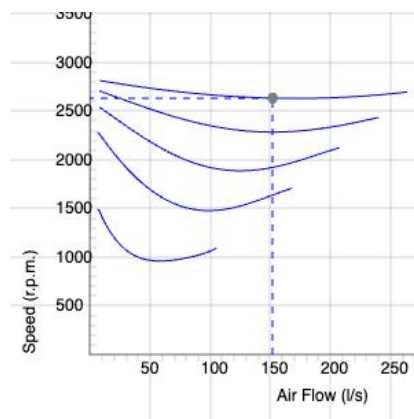

- Duct fan with circular connections.
- Proven performance and reliability.
- Compact with high capacity and efficiency.
- Low sound levels.
- Operational in both 50 and 60 Hz.
- Impeller with backward curved blades.
- The external rotor motor has maintenance-free sealed ball-bearings and is very energy efficient.
- For speed control a transformer or electronic speed controller can be connected.
- Integrated motor protection.
- Junction box has enclosure class IP 54.
- Fan housing is manufactured from galvanized sheet steel.
- The fan is intended to be installed in a duct system.
- A duct connected fan can be installed outside or in damp environments.
- Easy installation in any position.

## DIAGRAMS

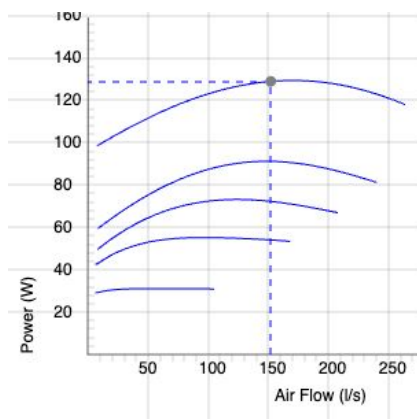
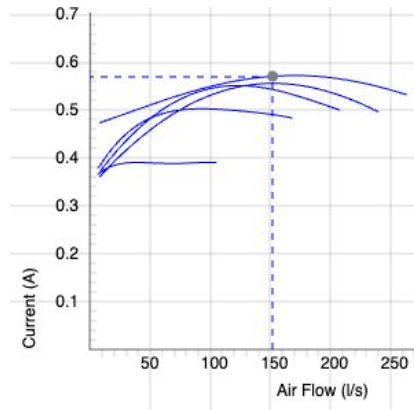
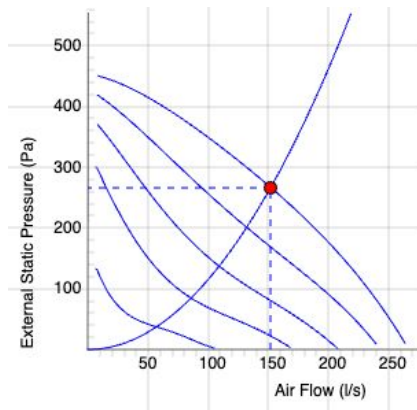

## Data

Air Flow (l/s) 152	External static pressure (Pa) 267	Power (W) 129	Speed (r.p.m.) 2633	Current (A) 0.571	Voltage (V) 230
-----------------------	--------------------------------------	------------------	------------------------	----------------------	--------------------

## DIAGRAMS

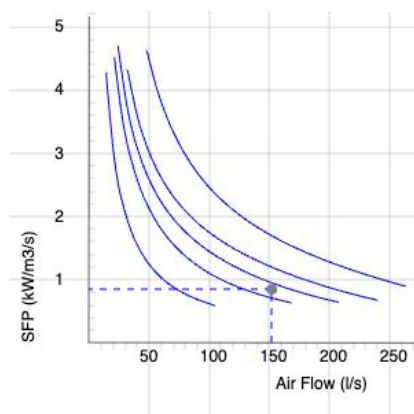
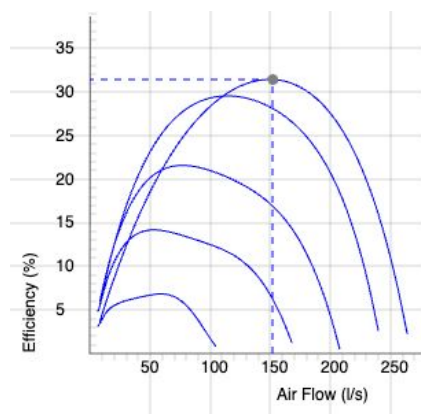

## DATA

Efficiency (%)  
31.4

SFPv (kW/m<sup>3</sup>/s)  
0.848

## SOUND DATA

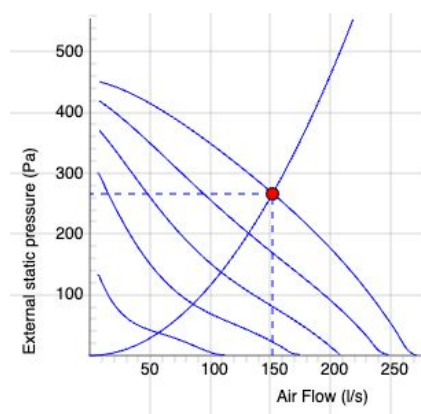

	Tot	63	125	250	500	1k	2k	4k	8k
Inlet Lw dB(A)	75	53	61	68	69	65	68	67	57
Outlet Lw dB(A)	76	58	62	71	69	65	68	68	60
Surrounding Lw dB(A)	51	17	31	40	47	46	40	38	31
Surrounding Lp dB (A) 20m <sup>2</sup> Sabine, hemispherical 3m	44								

## Data - SOUND

Air Flow (l/s) 152	External static pressure (Pa) 267	Power (W) 129	Speed (r.p.m.) 2633	Current (A) 0.571	Efficiency (%) 31.4	SFPv (kW/m <sup>3</sup> /s) 0.848	Voltage (V) 230
-----------------------	--------------------------------------	------------------	------------------------	----------------------	------------------------	--------------------------------------	--------------------

## TECHNICAL DATA

### CK 200 A1-v1 7000427

Parameter	Value	Unit
Voltage	230	V
Phase	1	~
Frequency	50	Hz
Optional frequency	60	Hz
Power	129	W
Current	0.57	A
Speed	2630	r.p.m.
Max. temperature of transported air	60	°C
Max. temperature of transported air when speed controlled	60	°C
Sound pressure level at 3 m	43	dB(A)
Weight	4.1	kg
Enclosure class	44	IP
Insulation class, motor	F	
Capacitor	4	µF
Duct connection	200	mm
Max. flow @ 0Pa	267	l/s
Max. pressure	457	Pa
Voltage range	220-240	V

## PRODUCT INFORMATION SHEET

Parameter	Value	Unit
(a) Manufacturer	Östberg	-
(b) Model code	CK 200 A1	-
(c) Declared type	NRVU / UVU	-
(d) Type of drive	Multi-speed drive (accessory)	-
(e) Type of HRS	N/A	-
(f) Thermal efficiency	N/A	%
(g) Nominal flow rate	0.152	m <sup>3</sup> /s
(h) Effective power input	0.129	kW
(i) SFP int	N/A	W/(m <sup>3</sup> /s)
(j) Face velocity	4.8	m/s
(k) Nominal external pressure	269	Pa
(l) Internal pressure drop	N/A	Pa
(n) Static efficiency	29.0	%
(o) External (and internal) leakage rate	0.27 (N/A)	%
(p) Filter classification	N/A	kWh
(q) Visual filter warning	N/A	-
(r) Sound power level	50	dB LwA
(s) Disassembly instructions	fsp.ostberg.com	-

## WIRING DIAGRAM

4040001

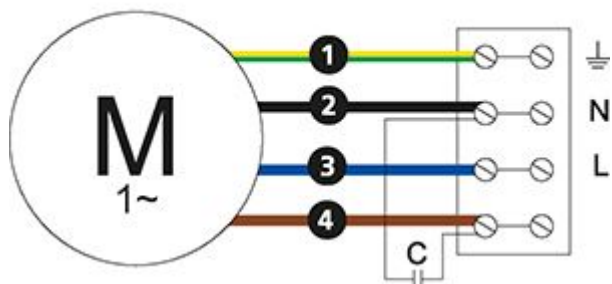

Ⓜ = Fan Motor

Ⓜ1 = Fan Motor

Ⓜ2 = Fan Motor

Ⓜ3 = Rotor Motor

① = Yellow/Green

② = Black

③ = Blue

④ = Brown

⑤ = White

⑥ = Orange

⑦ = Grey

⑧ = Red

⑨ = Green

⑩ = Violet

⑪ = Quick switch

⑫ = Yellow

## DIMENSIONS

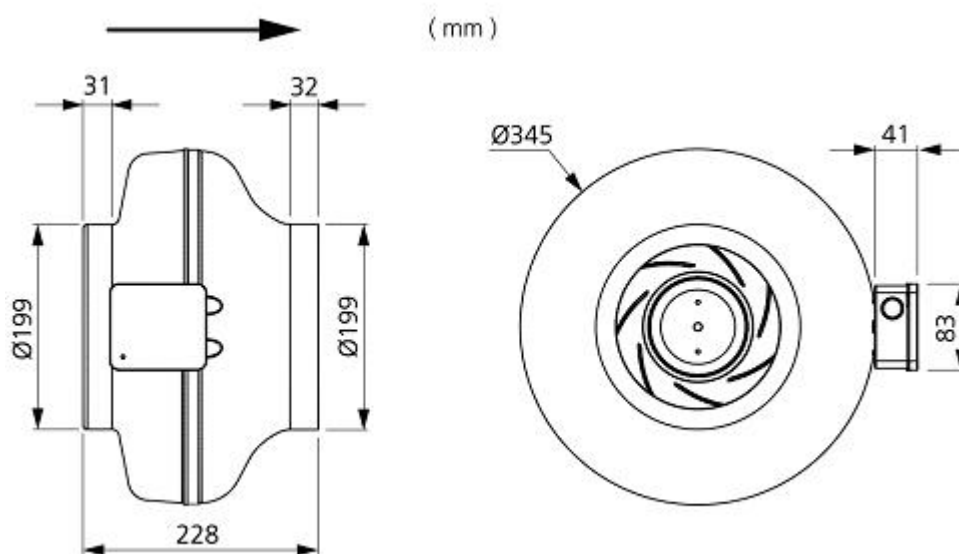

## ACCESSORIES

### Mechanical accessories



Mounting bracket Kit MB



Mounting clamp MK 200



Safety grille BSV 200



Back draught shutter RSK 200



Louvre YG 200



Louvre shutter VK 200



Filterbox FLK 200



Filterbox FLF 200



Silencer LDC 200

### Electrical accessories



Transformer controller VRTE C



Transformer controller VRDE 1.5



Speed controller VRS 1.5



Local Demand Controller Kit