

# Halton Jaz Cloud Ceiling (JCC) – Diffuser



## Overview

### Features

- Ceiling diffuser with side slot in square and circular shape
- Low construction height minimizes the installation space
- Diffuser is available for air supply and exhaust
- Installation either directly to ductwork or to balancing plenum
- Detachable front panel enables the cleaning of the diffuser and ductwork
- Deflector panels available for selection of flow pattern in 1-4 directions

### Accessories

- Deflector panel to provide control for flow pattern direction
- Balancing plenum with measurement and adjustment functions
- Installation panel for modular ceiling
- Control knob when in use with cabin units (ships and ferries)

### Product models

- Square, with solid or perforated front panel
- Circular, with solid or perforated front panel
- Direct installation to the standard T-bar ceiling opening
- Material alternative in stainless steel (EN1.4404/AISI316L)

# Quick selection

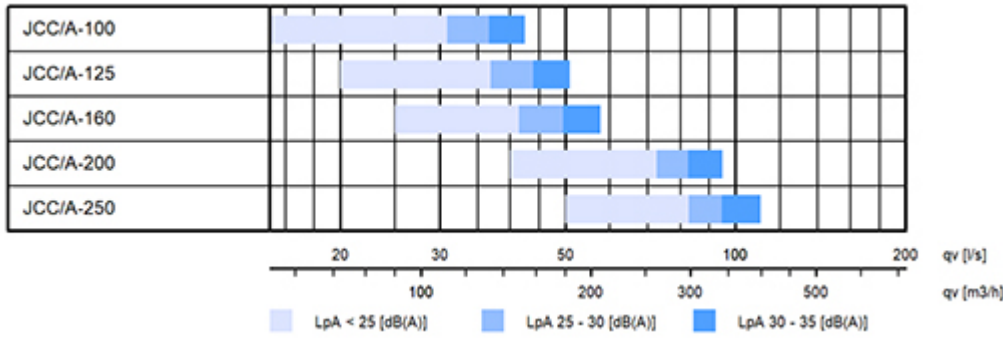

Fig.1. Halton Jaz Cloud Ceiling with square front panel, supply

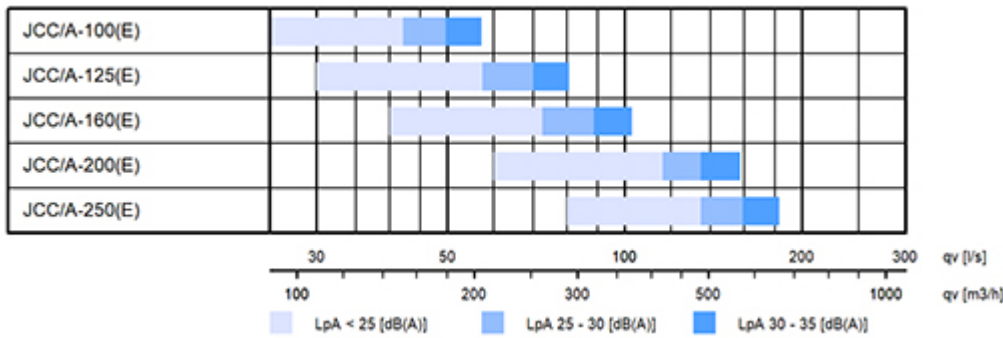

Fig.2. Halton Jaz Cloud Ceiling with square front panel, exhaust

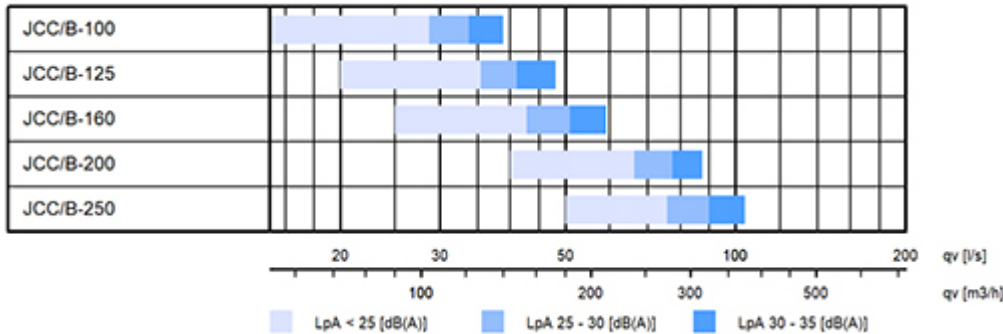

Fig.3. Halton Jaz Cloud Ceiling with circular front panel, supply

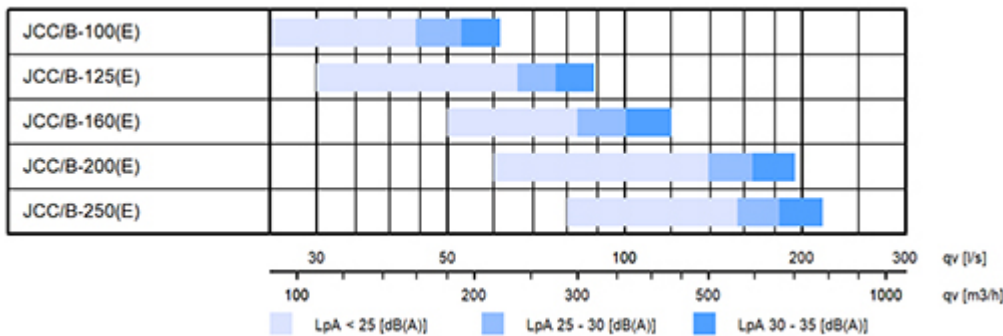
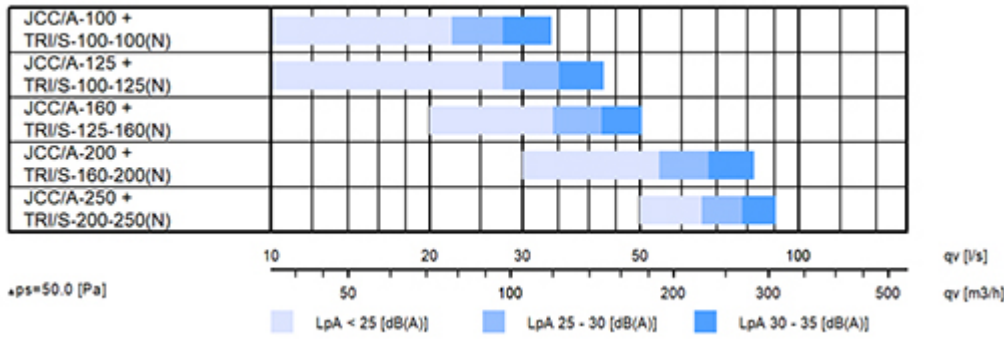
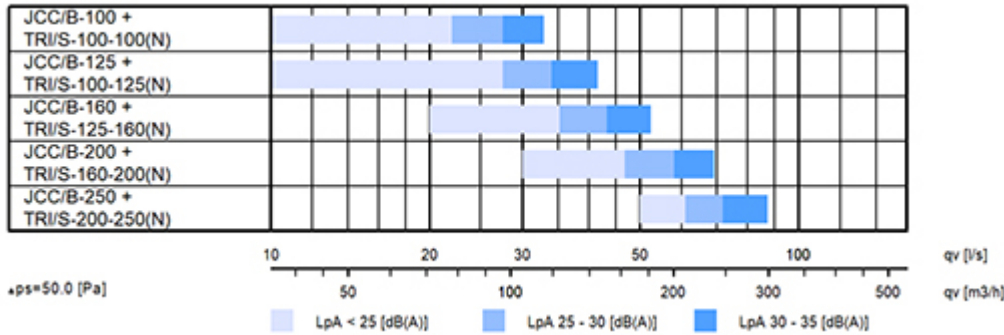

Fig.4. Halton Jaz Cloud Ceiling with circular front panel, exhaust



**Fig.5.** Halton Jaz Cloud Ceiling with square front panel and Halton TRI, supply



**Fig.6.** Halton Jaz Cloud Ceiling with circular front panel and Halton TRI, supply

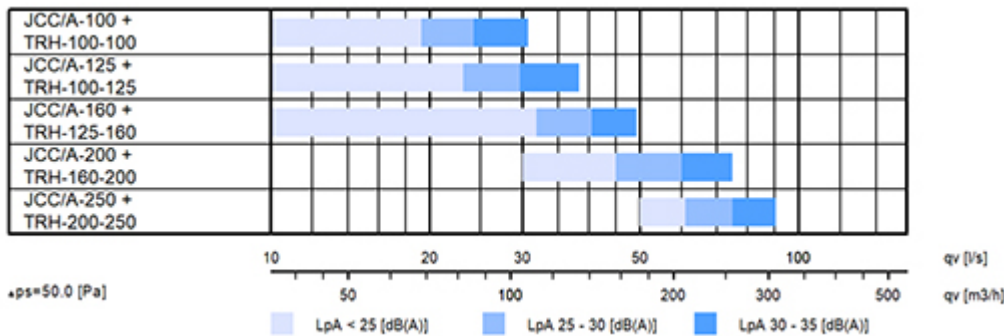

**Fig.7.** Halton Jaz Cloud Ceiling with square front panel and Halton TRH, supply

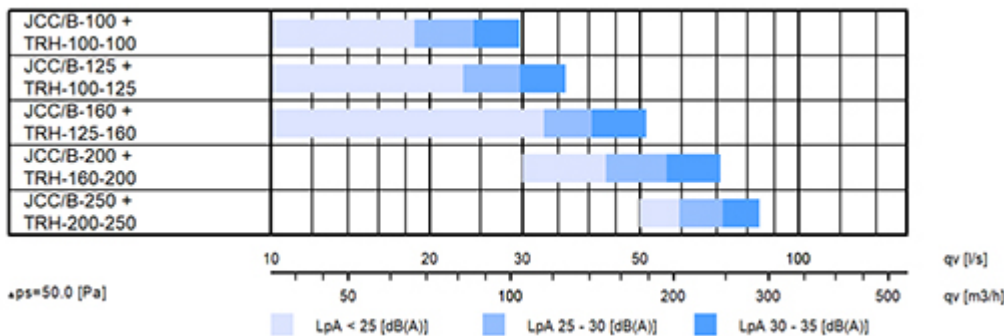

**Fig.8.** Halton Jaz Cloud Ceiling with circular front panel and Halton TRH, supply

# Dimensions

Halton Jaz Cloud Ceiling, square model (A,C)

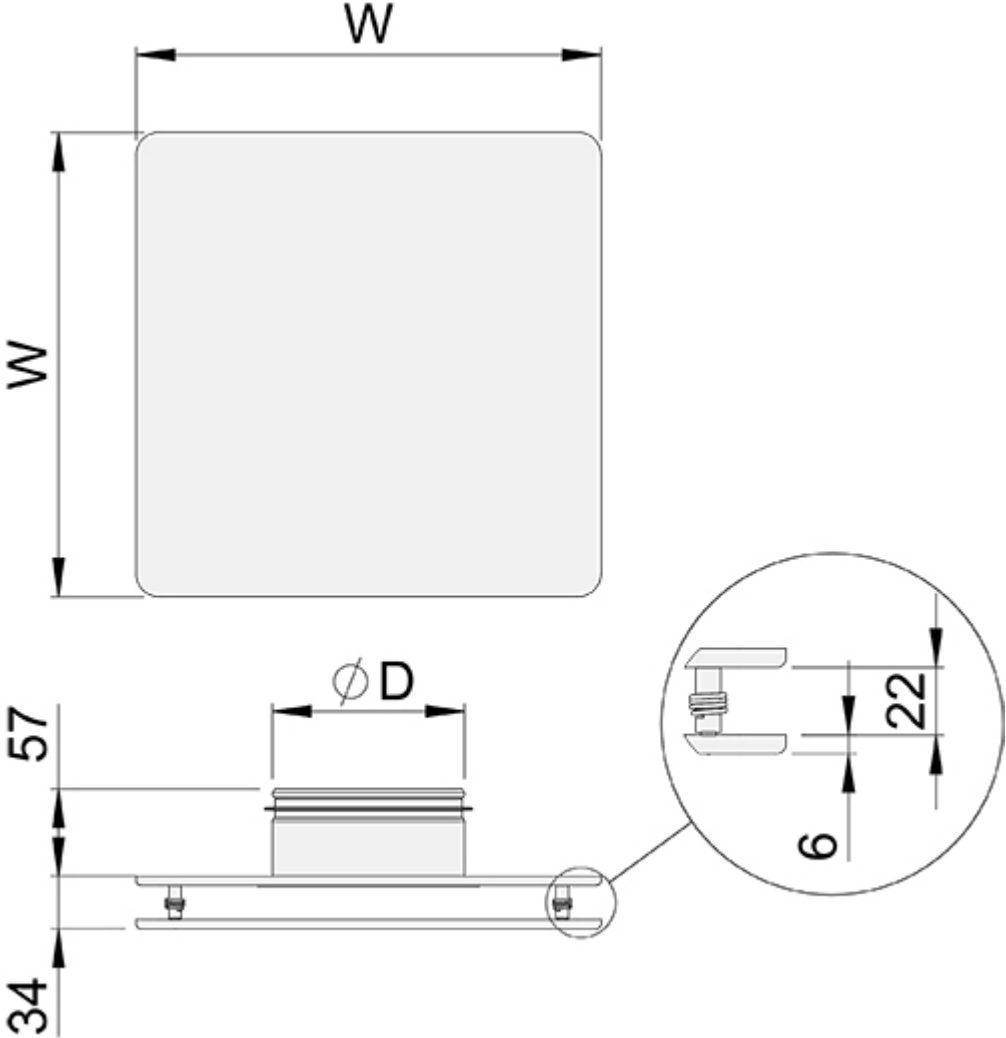

# Halton Jaz Cloud Ceiling, circular model (B,D)

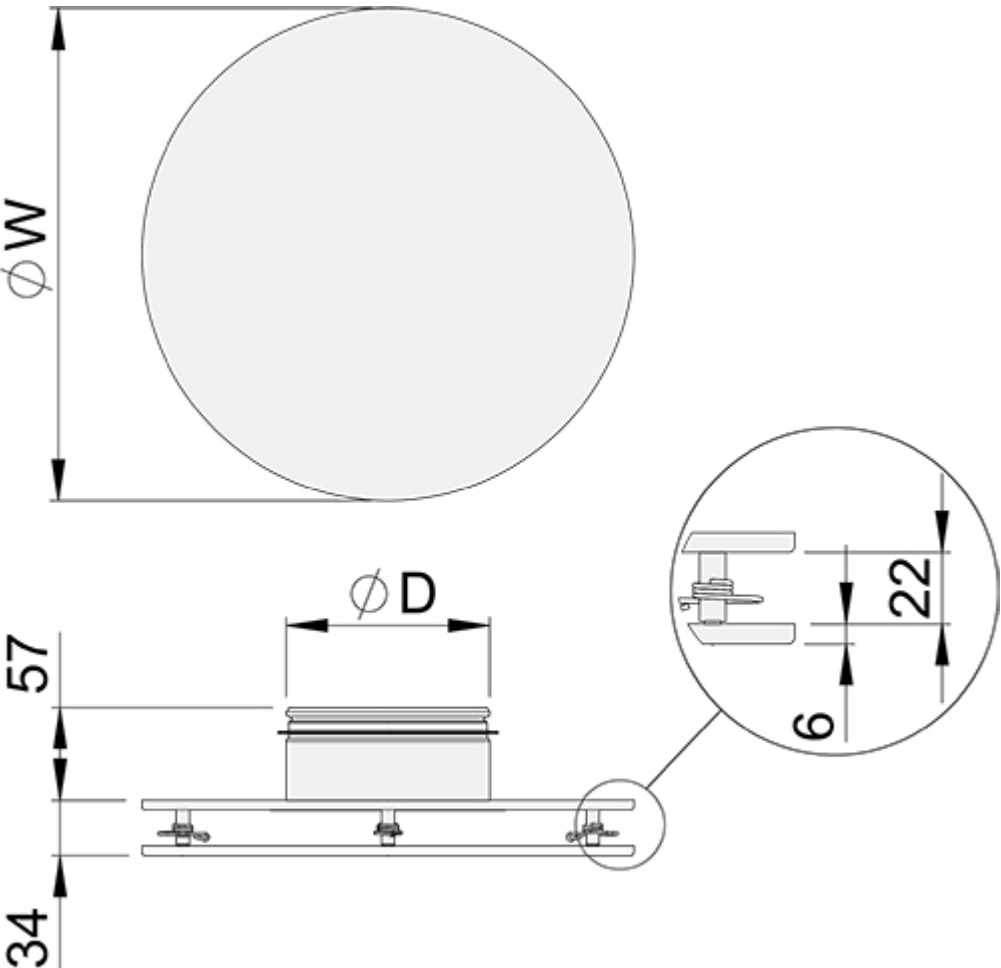

# Halton Jaz Cloud Ceiling, square ceiling integrated model

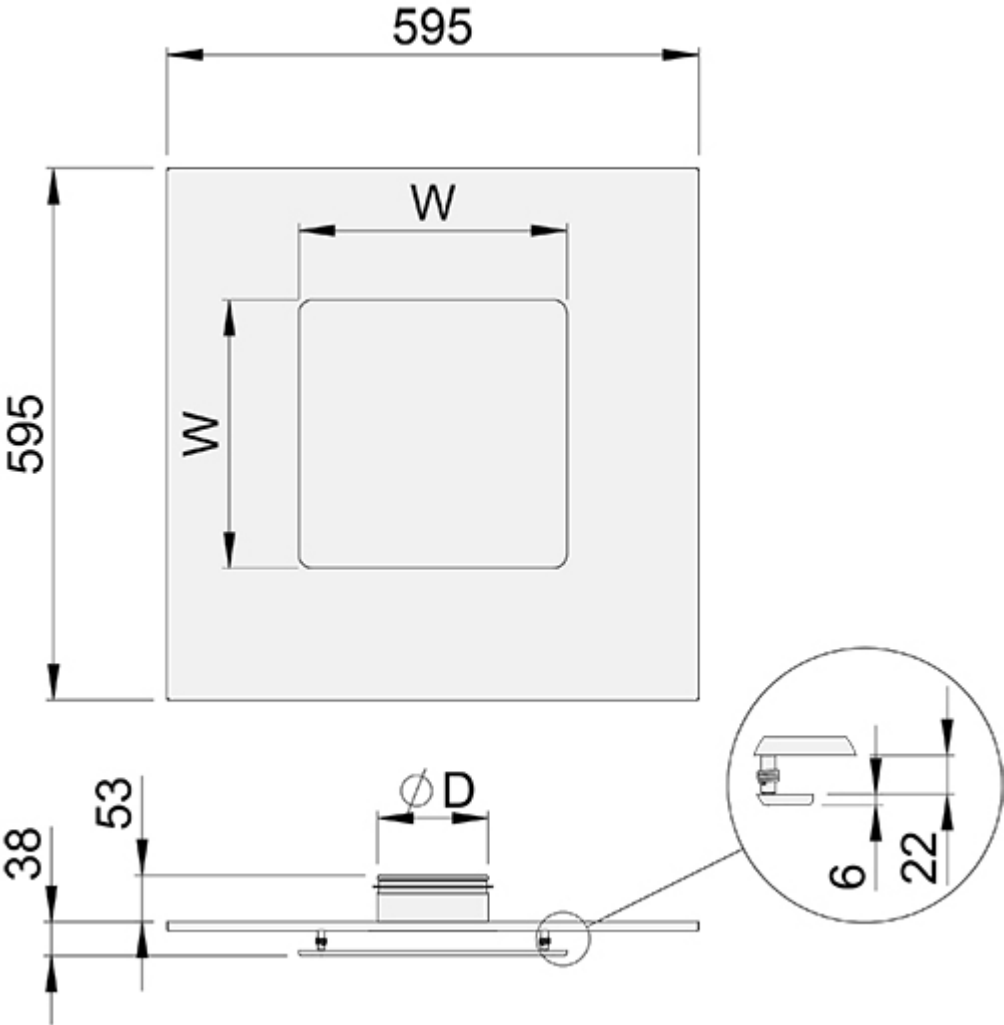

# Halton Jaz Cloud Ceiling, circular ceiling integrated model

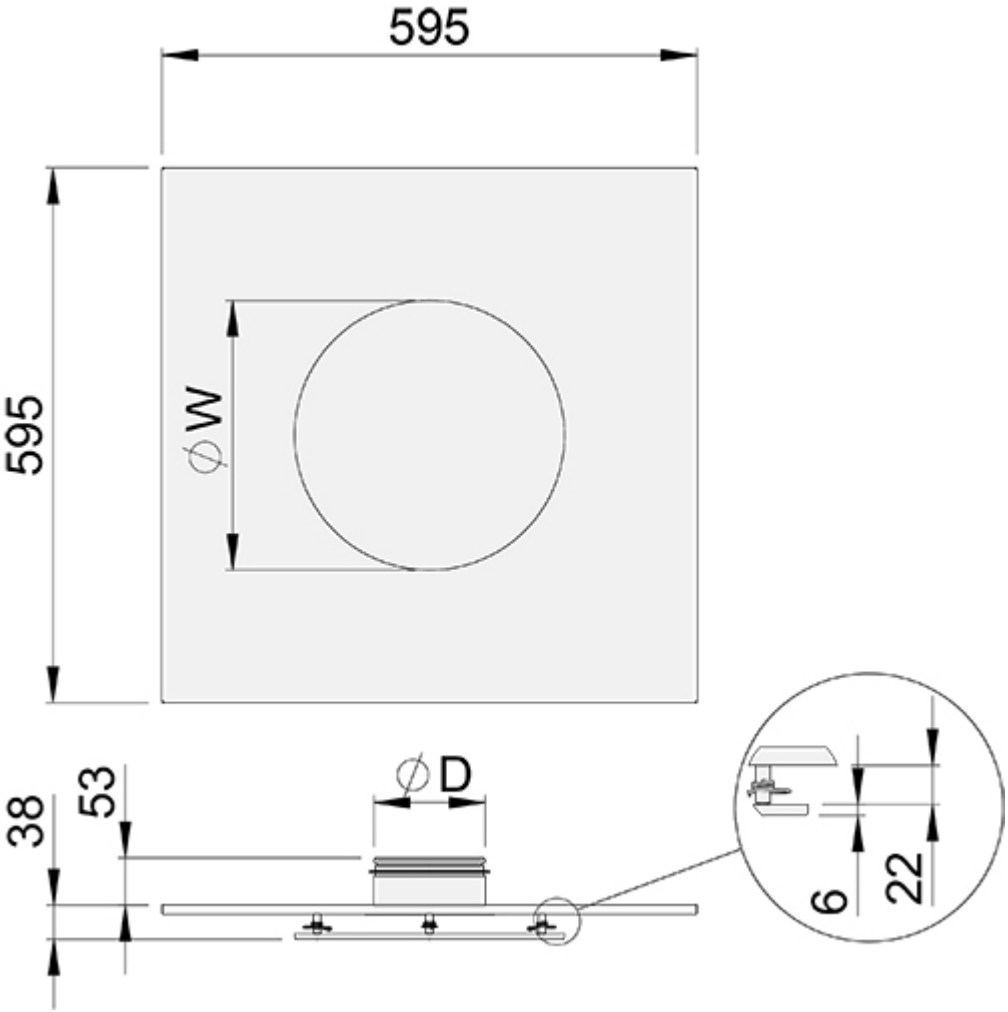

NS	W	$\phi D$
100	300	99
125	300	124
160	300	159
200	450	199
250	450	249

## Halton Jaz Cloud Ceiling with Halton TRH balancing plenum

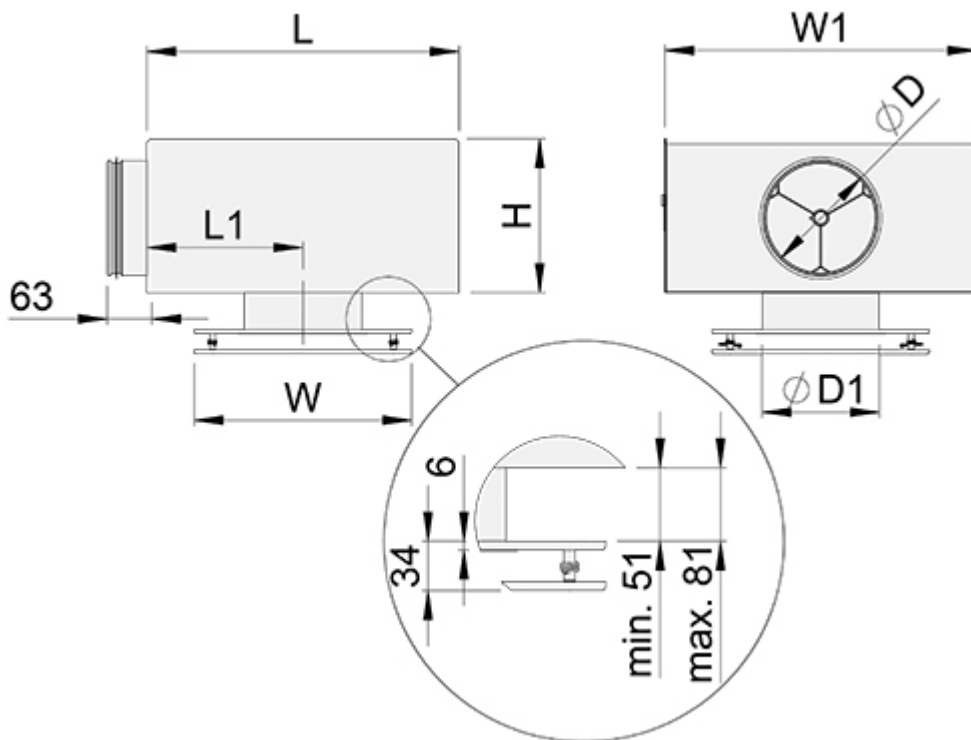

JCC	W	TRH	ØD	ØD1	L	W1	H	L1
100	300	100-100	99	102	281	281	152	141
125	300	100-125	99	127	281	281	152	141
125	300	125-125	124	127	431	431	180	216
160	300	100-160	99	162	281	281	152	141
160	300	125-160	124	162	431	431	180	216
160	300	160-160	159	162	431	431	212	216
200	450	125-200	124	202	431	431	180	216
200	450	160-200	159	202	431	431	212	216
200	450	200-200	199	202	550	400	245	355
250	450	160-250	159	252	431	431	212	216
250	450	200-250	199	252	550	400	245	355
250	450	250-250	249	252	600	450	295	378

## Halton Jaz Cloud Ceiling with Halton TRI balancing plenum

Halton TRI, collar in external position



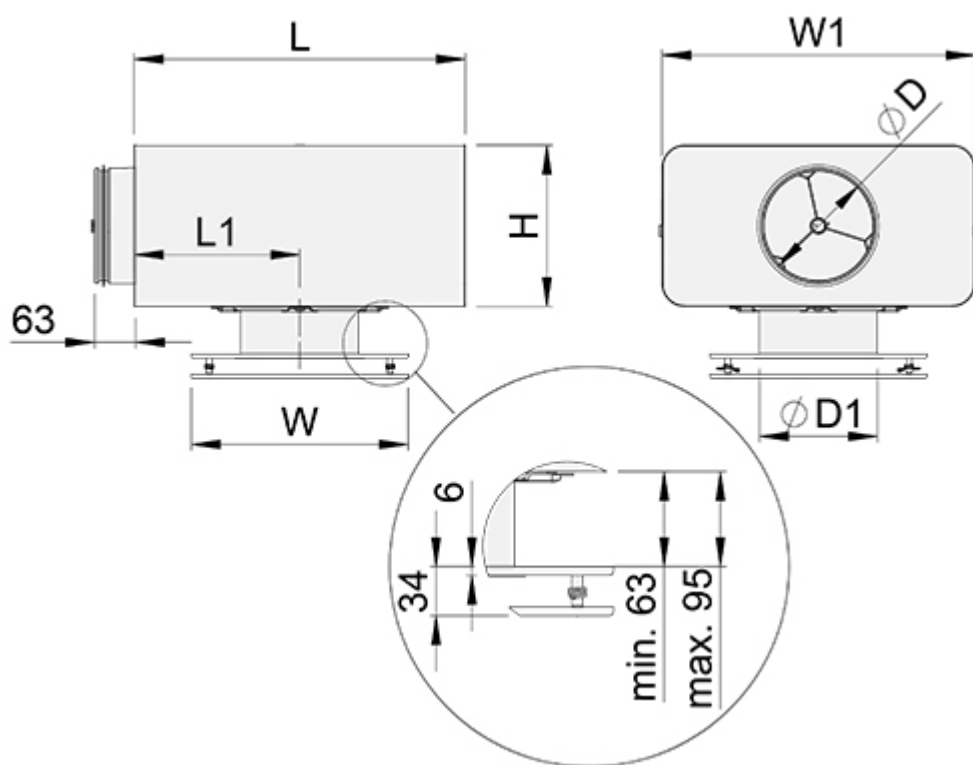

Halton TRI, collar in internal position

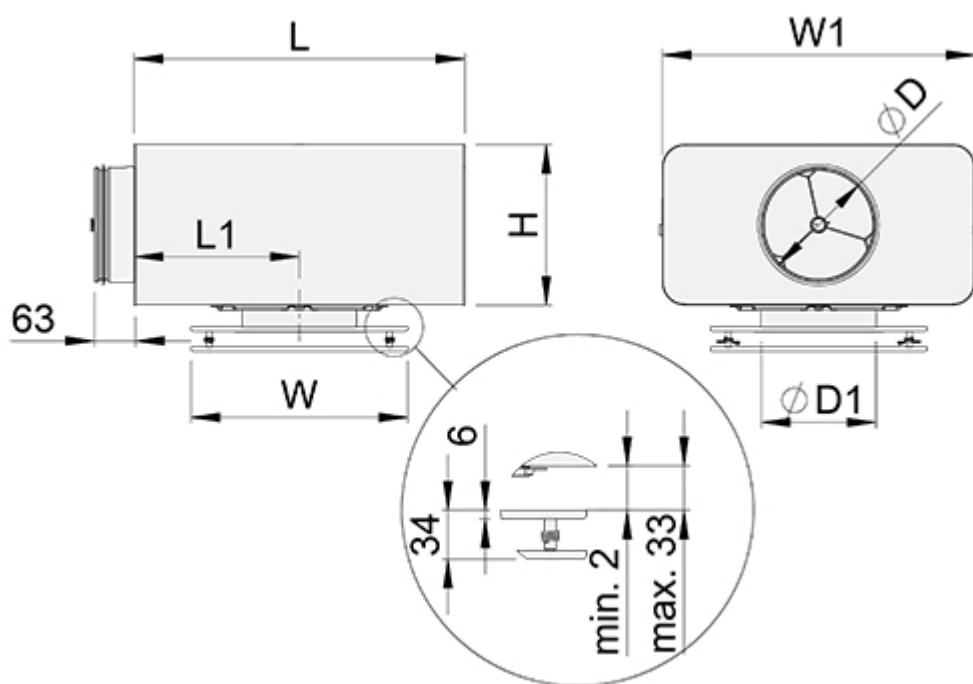

JCC	W	TRI	ØD	ØD1	L	W1	H	L1
100	300	100-100	99	102	308	282	152	154
125	300	100-125	99	127	308	282	152	154
125	300	125-125	124	127	458	432	182	229
160	300	100-160	99	162	308	282	152	154
160	300	125-160	124	162	458	432	182	229
160	300	160-160	159	162	458	432	222	229
200	450	125-200	124	202	458	432	182	229
200	450	160-200	159	202	458	432	222	229
200	450	200-200	199	202	618	592	272	309
250	450	160-250	159	252	458	432	272	229
250	450	200-250	199	252	618	592	272	309
250	450	250-250	249	252	618	592	336	309

## Weight (kg)

### Halton Jaz Cloud Ceiling, square

NS	Basic model	Ceiling integrated model
100	2.5	4.9
125	2.6	5.0
160	2.8	5.2
200	4.6	6.3
250	5.1	6.7

### Halton Jaz Cloud Ceiling, circular

NS	Basic model	Ceiling integrated model
100	1.2	3.7
125	1.2	3.7
160	1.2	3.7
200	2.3	4.2
250	2.3	4.2

# Structure and materials

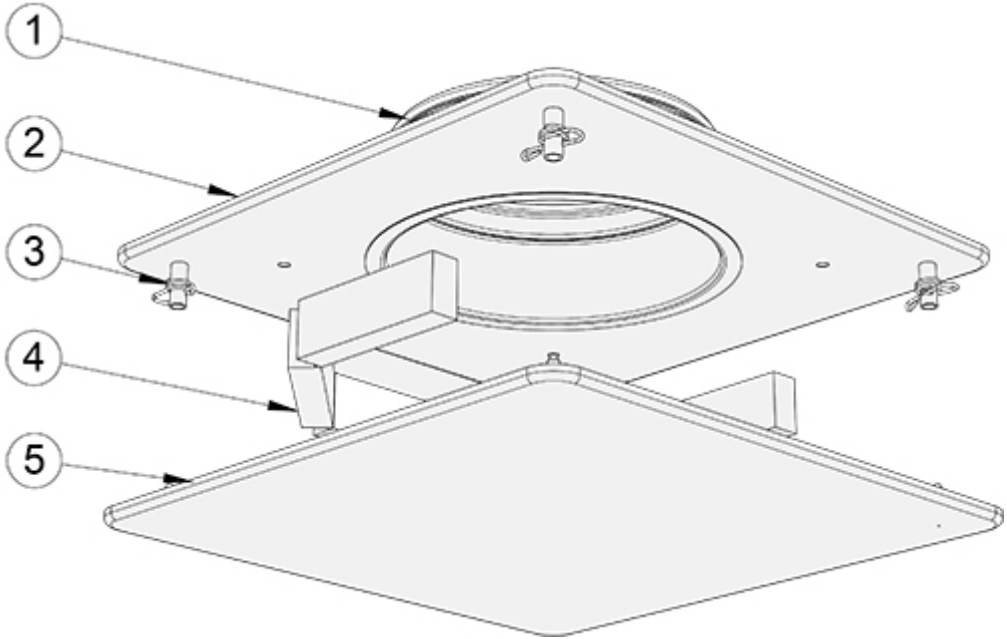

Key	Part	Material	Colour alternatives
1	Duct seal gasket	Rubber	–
2	Upper plate	Steel or stainless steel (EN1.4404/AISI 316L)	Powder paint, white (RAL 9003) Special colours available on request
3	Spring lock	Steel or stainless steel (EN1.4404/AISI 316L)	–
4	Deflector part	Foamed plastic	–
5	Front panel	Steel or stainless steel (EN1.4404/AISI 316L)	Powder paint, white (RAL 9003) Special colours available on request

**Note:** Same material options available for circular and square models.

# Accessories

Accessory	Code	Description
Deflector part	DP	A set of parts for providing the flow pattern in 3, 2 and 1 directions (accessory not needed for 4 direction flow). See Fig.1.
Balancing plenum box	TRH	For balancing and equalising the airflow and attenuating the duct noise (mineral wool or polyester fibre) See Fig.2.
Balancing plenum box	TRI	For balancing and equalising the airflow and attenuating the duct noise (polyester fibre) See Fig.3.
Installation panel	PI	For standard 600×600 module ceiling installation, colour white (RAL 9003) See Fig.4. and 5.
Control knob	CK	For controlling cabin unit (ships and ferries)

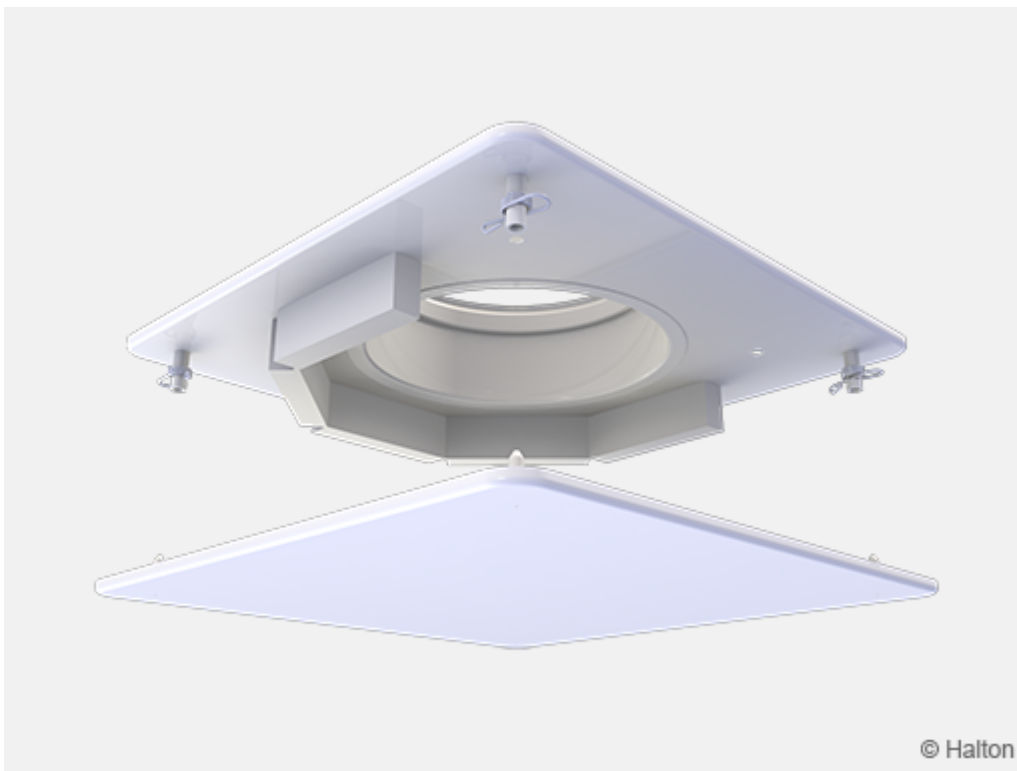

**Fig.1.** Deflector panel attached to diffuser (DP)

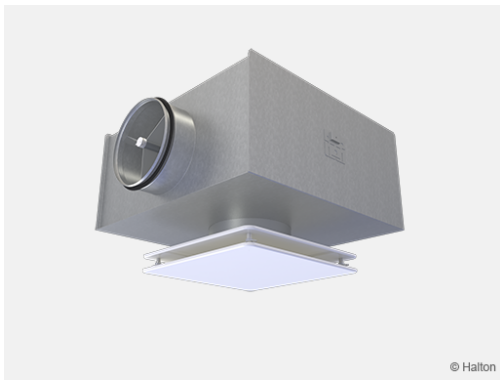

**Fig.2.** Installation with Halton TRH



**Fig.3.** Installation with Halton TRI



**Fig.4.** Square diffuser with installation panel (PI)



**Fig.5.** Circular diffuser with installation panel (PI)



**Fig.6.** Diffuser with control knob (CK)



# Function

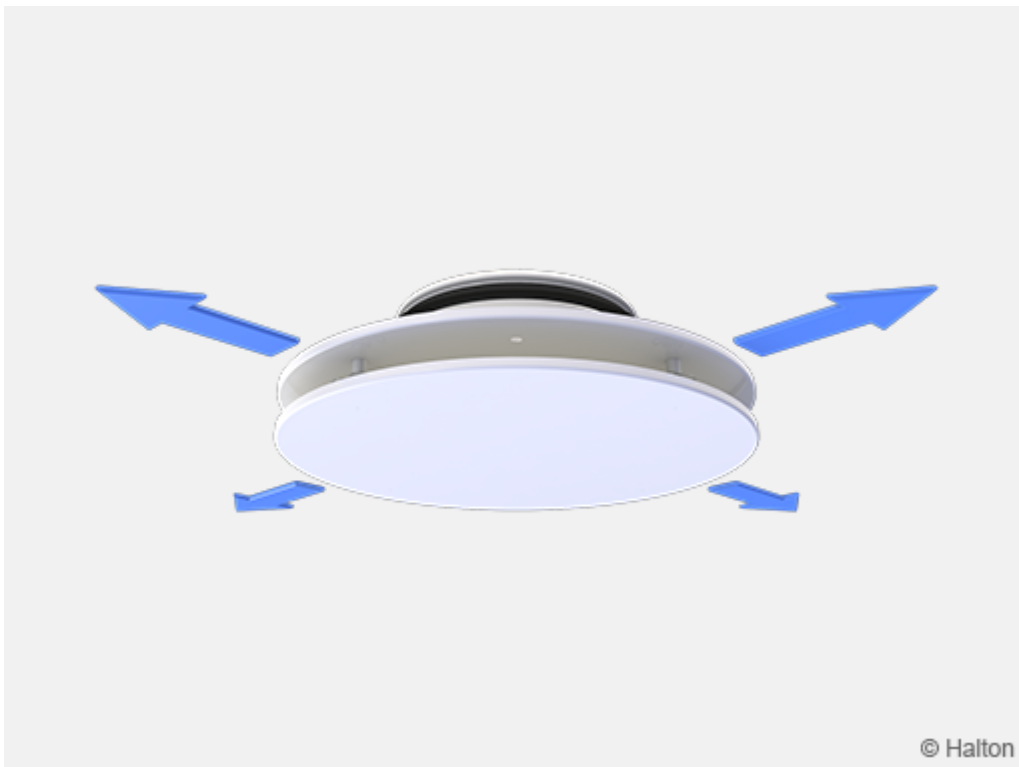
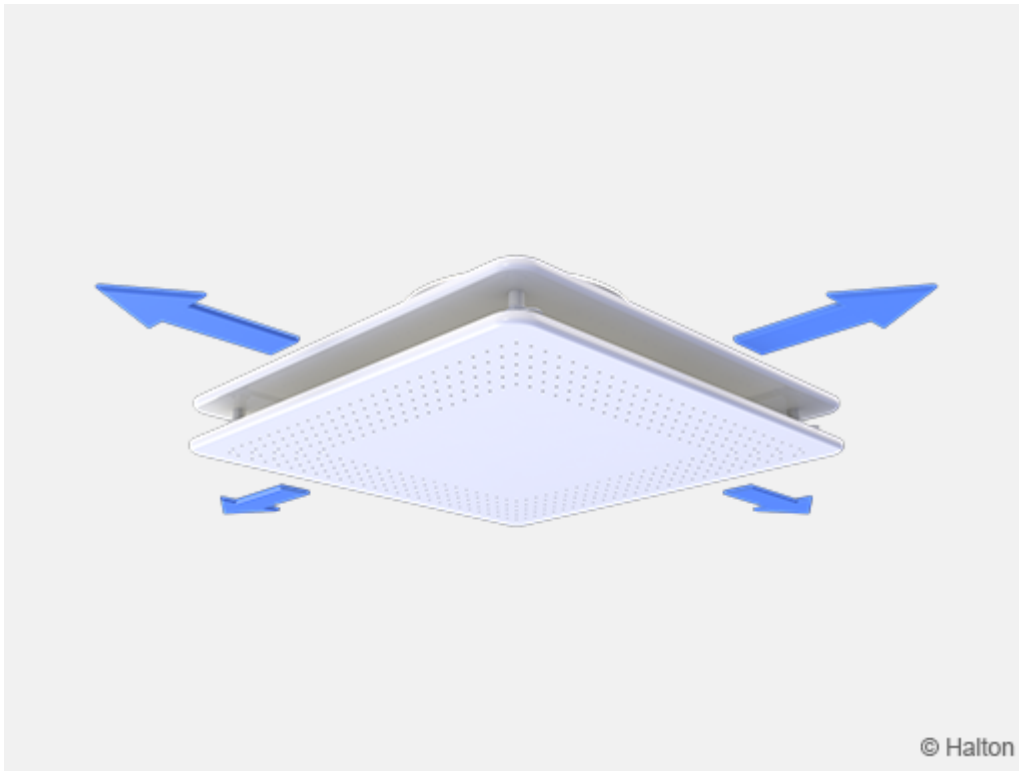

Air is supplied into the space through the side slots and mixed with the room air outside the diffuser.

Recommended maximum air temperature difference between supply and room air is 10 °C.

The throw pattern can be deflected in different (1, 2 and 3) directions with the deflection parts

(included in delivery).

Deflection part not needed for 4 direction supply or exhaust airflow .

## Product models



**Fig.1.** Halton Jaz Cloud Ceiling, square with solid front panel (A)



**Fig.2.** Halton Jaz Cloud Ceiling, circular with solid front panel (B)



**Fig.3.** Halton Jaz Cloud Ceiling, square with perforated front panel (C)



**Fig.4.** Halton Jaz Cloud Ceiling, circular with perforated front panel (D)





**Fig.5.** Halton Jaz Cloud Ceiling, square solid ceiling integrated model (WS=T)



**Fig.6.** Halton Jaz Cloud Ceiling, circular solid ceiling integrated model (WS=T)

## Installation

The diffuser is connected either to the duct by screwing or by riveting or alternatively to the Halton TRH or TRI balancing plenum. The duct connection spigot is equipped with a seal gasket. The diffuser can be installed:

- Flush with the ceiling
- Without the ceiling

The desired flow pattern is selected during installation with the deflector parts, according to the Installation and maintenance guide.

In an exhaust application deflector part is not used.

The recommended minimum safety distance upstream of the diffuser is 3xD with straight duct. When using balancing plenum no safety distance is required between the diffuser and the plenum.

**NOTE:** Step-by-step instructions on how to install the diffuser can be found in the Halton Jaz Cloud Ceiling Installation and maintenance guide. To download the guide go to the “Downloads” section.

## Adjustment

The diffuser itself has no means for airflow adjustment.

In order to enable airflow adjustment and measurement of supply airflow rate it is recommended to connect the diffuser to the Halton TRI or TRH balancing plenum. The supply flow rate is determined by using the measurement and adjustment module MSM. In case of exhaust air, use of adjustment module MEM is recommended. It is not possible to measure exhaust airflow rate with adjustment module MEM.

Open the front plate and pass the tubes and control spindle through the side slot of the diffuser. Replace the front panel.

Measure the differential pressure with a manometer. The flow rate is calculated using the formula below:

$$q_v = k * \sqrt{\Delta p_m}$$

$\Delta p_m$  Measured pressure [Pa]

$k$  The k factor given as a function of mounting and diameter

$q_v$  Airflow rate [l/s]

Adjust the airflow rate by rotating the control spindle until the desired setting is achieved. Lock the damper position with a screw.

Set the tubes and spindle back into the plenum and push back the diffuser front panel.

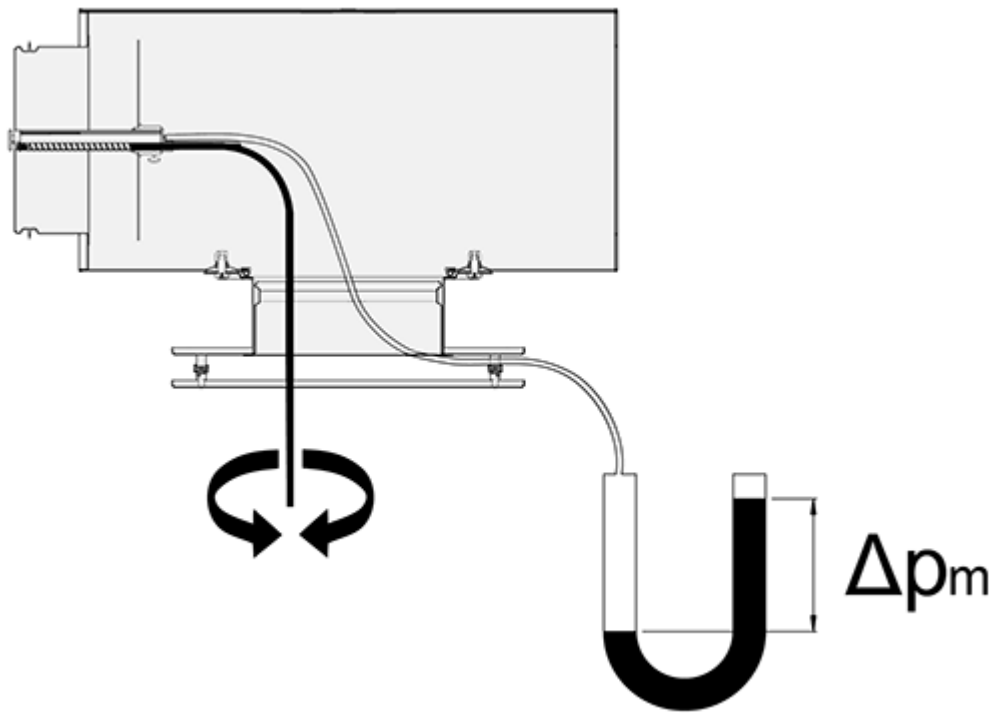

The k-factor for installations with different safety distances  
(D = duct diameter)

#### Halton TRI

TRI	> 8xD	min. 3xD
100	6.0	7.5
125	9.9	12.6
160	16.9	21.9
200	28.3	32.0
250	47.9	51.5

#### Halton TRH

TRH	> 8xD	min. 3xD
100	6.5	7.5
125	10.8	12.6
160	19.4	21.9
200	29.7	31.0
250	48.8	51.5

# Servicing

Open the front panel of the diffuser and clean the parts by wiping them with a damp cloth. Push the front panel back into place so that the springs lock.

## Option with balancing plenum

Open the front panel of the diffuser.

Remove the measurement and adjustment module by gently pulling the shaft.

**Note:** Not the control spindle or measurement tubes!

Wipe the parts with a damp cloth, instead of immersing in water.

Remount the measurement and adjustment module by pushing in the shaft until the unit meets the stopper.

Push the front panel back into place so that the springs lock.

# Specification

The diffuser is made of painted steel with a white (RAL 9003) standard colour or stainless steel (EN1.4404/AISI 316L). Air is introduced into the space through the side slot, ensuring a high mixing rate. The flow pattern of the diffuser is as standard for 4 directions. It is adjustable in 1, 2, or 3 -way directions by shaping the deflector.

## Alternative 1: Without balancing plenum

The diffuser has a spigot with integral gasket for connection to circular duct.

The diffuser has a detachable solid or perforated front panel to provide access to the duct.

## Alternative 2: With balancing plenum

The diffuser is connected to a balancing plenum equipped with a measurement and adjustment module.

The diffuser has a detachable solid or perforated front panel to provide access to the measurement and adjustment module in the plenum.

The balancing plenum has a spigot with integral gasket for airtight duct connection.

The balancing plenum comprises sound attenuation material made of polyester fibre with a washable surface or mineral wool.

# Order code

## JCC/M-D, MA-CO-WS-ZT

### M = Model

- A Square with solid front panel
- B Circular with solid front panel
- C Square with perforated front panel
- D Circular with perforated front panel

### D = Nominal duct connection size (mm)

100, 125, 160, 200, 250

## Other options and accessories

### MA = Material

- ST Steel
- AS Stainless steel (EN1.4404/AISI 316L)

### CO = Colour

- SW Signal white (RAL 9003)
- X Special colour (RAL xxxx)
- NA Not assigned

### WS = Ceiling integration model

- NA Not assigned
- T Standard T-bar ceiling (tile 600x600)

### DP = Deflection panels

- Y Yes
- N No

### CK = Control knob (for cabin units only)

- N No
- Y Yes

### ZT = Tailored product

- N No
- Y Yes (ETO)

## Code example

JCC/A-200, MA=ST, CO=SW, WS=NA, ZT=N