

Service Manual

Air Conditioner

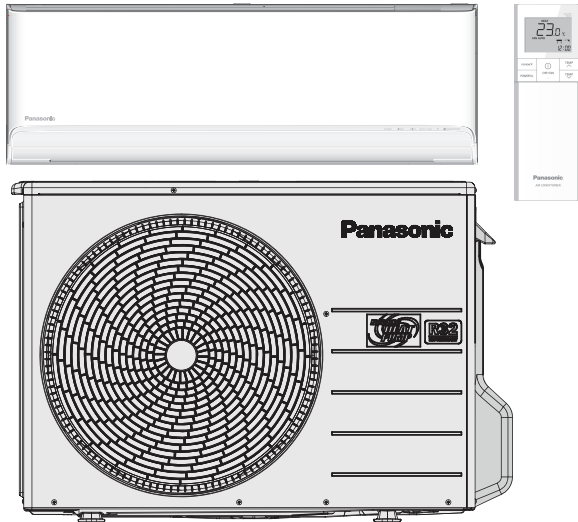

Indoor Unit
CS-HZ25XKE
CS-HZ35XKE
CS-HZ25XKE-5

Outdoor Unit
CU-HZ25XKE
CU-HZ35XKE
CU-HZ25XKE-5

Destination
North Europe

WARNING

This service information is designed for experienced repair technicians only and is not designed for use by the general public. It does not contain warnings or cautions to advise non-technical individuals of potential dangers in attempting to service a product. Products powered by electricity should be serviced or repaired only by experienced professional technicians. Any attempt to service or repair the products dealt with in this service information by anyone else could result in serious injury or death.

IMPORTANT SAFETY NOTICE

There are special components used in this equipment which are important for safety. These parts are marked by  in the Schematic Diagrams, Circuit Board Diagrams, Exploded Views and Replacement Parts List. It is essential that these critical parts should be replaced with manufacturer's specified parts to prevent shock, fire or other hazards. Do not modify the original design without permission of manufacturer.

CAUTION



R32 REFRIGERANT – This Air Conditioner contains and operates with refrigerant R32.
THIS PRODUCT MUST ONLY BE INSTALLED OR SERVICED BY QUALIFIED PERSONNEL.
 Refer to National, State, Territory and local legislation, regulations, codes, installation & operation manuals, before the installation, maintenance and/or service of this product.

TABLE OF CONTENTS



	PAGE		PAGE
1. Safety Precautions	3	14.5 Quiet Operation (Cooling Mode/Cooling Area of Dry Mode)	67
2. Precaution for Using R32 Refrigerant	5	14.6 Quiet Operation (Heating)	68
3. Specification	10	14.7 Powerful Mode Operation	68
4. Features	16	14.8 Timer Control	68
5. Location of Controls and Components	17	14.9 Sleep Mode Operation	69
5.1 Indoor Unit	17	14.10 Auto Restart Control	70
5.2 Outdoor Unit	17	14.11 Indication Panel	70
5.3 Remote Control	17	14.12 +8/15°C Heat Operation	71
6. Dimensions	18	14.13 nanoe™ X Operation	72
6.1 Indoor Unit	18	14.14 Wireless LAN Control	74
6.2 Outdoor Unit	19	15. Protection Control	77
7. Refrigeration Cycle Diagram	20	15.1 Protection Control for All Operations	77
8. Block Diagram	21	15.2 Protection Control for Cooling & Soft Dry Operation	79
8.1 Indoor Power Supply Connection	21	15.3 Protection Control for Heating Operation	80
8.2 Outdoor Power Supply Connection	22	16. Servicing Mode	81
9. Wiring Connection Diagram	23	16.1 Auto OFF/ON Button	81
9.1 Indoor Unit	23	16.2 Heat Only Operation	82
9.2 Outdoor Unit	24	16.3 Remote Control Button	83
10. Electronic Circuit Diagram	25	17. Troubleshooting Guide	92
10.1 Indoor Unit	25	17.1 Refrigeration Cycle System	92
10.2 Outdoor Unit	26	17.2 Breakdown Self Diagnosis Function	94
11. Printed Circuit Board	27	17.3 Error Code Table	95
11.1 Indoor Unit	27	17.4 Self-diagnosis Method	97
11.2 Outdoor Unit	29	18. Disassembly and Assembly Instructions ...	125
12. Installation Instruction	30	18.1 Indoor Unit	125
12.1 Select the Best Location	30	18.2 Outdoor Electronic Controller Removal Procedure	132
12.2 Indoor Unit	31	18.3 Panasonic Comfort Cloud	133
12.3 Outdoor Unit	36	19. Technical Data	146
13. Installation and Servicing Air Conditioner using R32	43	19.1 Cool Mode Performance Data	146
13.1 About R32 Refrigerant	43	19.2 Heat Mode Performance Data	147
13.2 Characteristics of R32 Refrigerant	43	20. Service Data	148
13.3 Refrigerant piping installation • Tools used in services	45	20.1 Cool Mode Outdoor Air Temperature Characteristic	148
13.4 New installation, Relocation, Repairing of Refrigerant Cycle System The Procedures	49	20.2 Heat Mode Outdoor Air Temperature Characteristic	150
13.5 Piping installation of R32	50	20.3 Piping Length Correction Factor	152
13.6 Installation, Relocation, and Service	51	21. Exploded View and Replacement Parts List	153
13.7 Repairing of refrigerant cycle / Brazing point	55	21.1 Indoor Unit	153
13.8 <Reference> Analysis method for no error code, no cooling / no warming	61	21.2 Outdoor Unit	156
14. Operation Control	63		
14.1 Basic Function	63		
14.2 Indoor Fan Motor Operation	64		
14.3 Outdoor Fan Motor Operation	65		
14.4 Airflow Direction	66		

1. Safety Precautions



















- Read the following “SAFETY PRECAUTIONS” carefully before installation and perform any servicing.
- Electrical work must be installed by a licensed electrician. Be sure to use the correct rating of the power plug and main circuit for the model to be installed.
- The caution items stated here must be followed because these important contents are related to safety. The meaning of each indication used is as below. Incorrect installation due to ignoring of the instruction will cause harm or damage, and the seriousness is classified by the following indications.

 WARNING	This indication shows the possibility of causing death or serious injury.
 CAUTION	This indication shows the possibility of causing injury or damage to properties only.















- The items to be followed are classified by the symbols:

	Symbol with white background denotes item that is PROHIBITED.
	Symbol with dark background denotes item that must be carried out.













- Carry out test running to confirm that no abnormality occurs after the installation. Then, explain to user the operation, care and maintenance as stated in instructions. Please remind the customer to keep the operating instructions for future reference.

 WARNING		
1.	Do not use means to accelerate the defrosting process or to clean, other than those recommended by the manufacturer. Any unfit method or using incompatible material may cause product damage, burst and serious injury.	
2.	Do not install outdoor unit near handrail of veranda. When installing air-conditioner unit on veranda of a high rise building, child may climb up to outdoor unit and cross over the handrail causing an accident.	
3.	Do not use unspecified cord, modified cord, joint cord or extension cord for power supply cord. Do not share the single outlet with other electrical appliances. Poor contact, poor insulation or over current will cause electrical shock or fire.	
4.	Do not tie up the power supply cord into a bundle by band. Abnormal temperature rise on power supply cord may happen.	
5.	Do not insert your fingers or other objects into the unit, high speed rotating fan may cause injury. 	
6.	Do not sit or step on the unit, you may fall down accidentally. 	
7.	Keep plastic bag (packaging material) away from small children, it may cling to nose and mouth and prevent breathing.	
8.	When installing or relocating air conditioner, do not let any substance other than the specified refrigerant, eg. air etc mix into refrigeration cycle (piping). Mixing of air etc. will cause abnormal high pressure in refrigeration cycle and result in explosion, injury etc.	
9.	Do not pierce or burn as the appliance is pressurized. Do not expose the appliance to heat, flame, sparks, or other sources of ignition. Else, it may explode and cause injury or death.	
10.	Do not add or replace refrigerant other than specified type. It may cause product damage, burst and injury etc.	
11.	<ul style="list-style-type: none"> • For R32/R410A model, use piping, flare nut and tools which is specified for R32/R410A refrigerant. Using of existing (R22) piping, flare nut and tools may cause abnormally high pressure in the refrigerant cycle (piping), and possibly result in explosion and injury. For R32 and R410A, the same flare nut on the outdoor unit side and pipe can be used. • Since the working pressure for R32/R410A is higher than that of refrigerant R22 model, replacing conventional piping and flare nuts on the outdoor unit side are recommended. • If reuse piping is unavoidable, refer to instruction “IN CASE OF REUSING EXISTING REFRIGERANT PIPING” • Thickness of copper pipes used with R32/R410A must be more than 0.8 mm. Never use copper pipes thinner than 0.8 mm. • It is desirable that the amount of residual oil less than 40 mg/10 m. 	
12.	Engage authorized dealer or specialist for installation or servicing. If installation and servicing done by the user is incorrect, it will cause water leakage, electrical shock or fire.	
13.	For refrigeration system work, Install according to this installation instructions strictly. If installation is defective, it will cause water leakage, electrical shock or fire.	
14.	Use the attached accessories parts and specified parts for installation. Otherwise, it will cause the set to fall, water leakage, fire or electrical shock.	
15.	Install at a strong and firm location which is able to withstand weight of the set. If the strength is not enough or installation is not properly done, the set will drop and cause injury.	
16.	For electrical work, follow the national regulation, legislation and this installation instructions. An independent circuit and single outlet must be used. If electrical circuit capacity is not enough or defect found in the electrical work, it will cause electrical shock or fire.	

 **WARNING**



















17.	Do not use joint cable for indoor/outdoor connection cable. Use the specified indoor/outdoor connection cable, refer to instruction CONNECT THE CABLE TO THE INDOOR UNIT and connect tightly for indoor/outdoor connection. Clamp the cable so that no external force will have impact on the terminal. If connection or fixing is not perfect, it will cause heat up or fire at the connection.	
18.	Wire routing must be properly arranged so that control board cover is fixed properly. If control board cover is not fixed perfectly, it will cause fire or electrical shock.	
19.	This equipment is strongly recommended to be installed with Earth Leakage Circuit Breaker (ELCB) or Residual Current Device (RCD), with sensitivity of 30mA at 0.1sec or less. Otherwise, it may cause electrical shock and fire in case of equipment breakdown or insulation breakdown.	
20.	During installation, install the refrigerant piping properly before running the compressor. Operation of compressor without fixing refrigeration piping and valves at opened position will cause suck-in of air, abnormal high pressure in refrigeration cycle and result in explosion, injury etc.	
21.	During pump down operation, stop the compressor before removing the refrigeration piping. Removal of refrigeration piping while compressor is operating and valves are opened will cause suck-in of air, abnormal high pressure in refrigeration cycle and result in explosion, injury etc.	
22.	Tighten the flare nut with torque wrench according to specified method. If the flare nut is over-tightened, after a long period, the flare may break and cause refrigerant gas leakage.	
23.	After completion of installation or servicing, confirm there is no leakage of refrigerant gas. It may generate toxic gas when the refrigerant contacts with fire.	
24.	Ventilate if there is refrigerant gas leakage during operation. It may cause toxic gas when the refrigerant contacts with fire.	
25.	Be aware that refrigerants may not contain an odour.	
26.	Do not modify the machine, part, material during repairing service.	
27.	If wiring unit is supplied as repairing part, do not repair or connect the wire even only partial wire break. Exchange the whole wiring unit.	
28.	Do not wrench the fasten terminal. Pull it out or insert it straightly.	
29.	Must not use other parts except original parts describe in catalog and manual.	
30.	This equipment must be properly earthed. Earth line must not be connected to gas pipe, water pipe, earth of lightning rod and telephone. Otherwise, it may cause electrical shock in case of equipment breakdown or insulation breakdown.	

 **CAUTION**

1.	Do not install the unit in a place where leakage of flammable gas may occur. In case gas leaks and accumulates at surrounding of the unit, it may cause fire.	
2.	Prevent liquid or vapor from entering sumps or sewers since vapor is heavier than air and may form suffocating atmospheres.	
3.	Do not release refrigerant during piping work for installation, servicing, re-installation and during repairing refrigeration parts. Take care of the liquid refrigerant, it may cause frostbite.	
4.	Do not install this appliance in a laundry room or other location where water may drip from the ceiling, etc.	
5.	Do not touch the sharp aluminium fin, sharp parts may cause injury. 	
6.	Carry out drainage piping as mentioned in installation instructions. If drainage is not perfect, water may enter the room and damage the furniture.	
7.	Select an installation location which is easy for maintenance. Incorrect installation, service or repair of this air conditioner may increase the risk of rupture and this may result in loss damage or injury and/or property.	
8.	Power supply connection to the room air conditioner. Use power supply cord 3 × 1.5 mm ² type designation 60245 IEC 57 or heavier cord. Connect the power supply cord of the air conditioner to the mains using one of the following method. Power supply point should be in easily accessible place for power disconnection in case of emergency. In some countries, permanent connection of this air conditioner to the power supply is prohibited. 1) Power supply connection to the receptacle using power plug. Use an approved 15/16A power plug with earth pin for the connection to the socket. 2) Power supply connection to a circuit breaker for the permanent connection. Use an approved 16A circuit breaker for the permanent connection. It must be a double pole switch with a minimum 3.0 mm contact gap.	
9.	Installation or servicing work. It may need two people to carry out the installation or servicing work.	
10.	Keep any required ventilation openings clear of obstruction.	
11.	Pb free solder has a higher melting point than standard solder; typically the melting point is 50°F – 70°F (30°C – 40°C) higher. Please use a high temperature solder iron. In case of the soldering iron with temperature control, please set it to 700 ± 20°F (370 ± 10°C). Pb free solder will tend to splash when heated too high (about 1100°F / 600°C).	

2. Precaution for Using R32 Refrigerant

- Pay careful attention to the following precaution points and the installation work procedures:

 WARNING		
1.	When connecting flare at indoor side, make sure that the flare connection is used only once, if torqued up and released, the flare must be remade. Once the flare connection was torqued up correctly and leak test was made, thoroughly clean and dry the surface to remove oil, dirt and grease by following instructions of silicone sealant. Apply neutral cure (Alkoxy type) & ammonia-free silicone sealant that is non-corrosive to copper & brass to the external of the flared connection to prevent the ingress of moisture on both the gas & liquid sides. (Moisture may cause freezing and premature failure of the connection)	
2.	The appliance shall be stored, installed and operated in a well ventilated room with indoor floor area larger than A_{min} (m ²) [refer Table A] and without any continuously operating ignition source. Keep away from open flames, any operating gas appliances or any operating electric heater. Else, it may explode and cause injury or death.	
3.	The mixing of different refrigerants within a system is prohibited. Models that use refrigerant R32 and R410A have a different charging port thread diameter to prevent erroneous charging with refrigerant R22 and for safety. Therefore, check beforehand. [The charging port thread diameter for R32 and R410A is 12.7 mm (1/2 inch).]	
4.	Ensure that foreign matter (oil, water, etc.) does not enter the piping. Also, when storing the piping, securely seal the opening by pinching, taping, etc. (Handling of R32 is similar to R410A.)	
5.	Operation, maintenance, repairing and refrigerant recovery should be carried out by trained and certified personnel in the use of flammable refrigerants and as recommended by the manufacturer. Any personnel conducting an operation, servicing or maintenance on a system or associated parts of the equipment should be trained and certified.	
6.	Any part of refrigerating circuit (evaporators, air coolers, AHU, condensers or liquid receivers) or piping should not be located in the proximity of heat sources, open flames, operating gas appliance or an operating electric heater.	
7.	The user/owner or their authorized representative shall regularly check the alarms, mechanical ventilation and detectors, at least once a year, where as required by national regulations, to ensure their correct functioning.	
8.	A logbook shall be maintained. The results of these checks shall be recorded in the logbook.	
9.	In case of ventilations in occupied spaces shall be checked to confirm no obstruction.	
10.	Before a new refrigerating system is put into service, the person responsible for placing the system in operation should ensure that trained and certified operating personnel are instructed on the basis of the instruction manual about the construction, supervision, operation and maintenance of the refrigerating system, as well as the safety measures to be observed, and the properties and handling of the refrigerant used.	
11.	The general requirement of trained and certified personnel are indicated as below: a) Knowledge of legislation, regulations and standards relating to flammable refrigerants; and, b) Detailed knowledge of and skills in handling flammable refrigerants, personal protective equipment, refrigerant leakage prevention, handling of cylinders, charging, leak detection, recovery and disposal; and, c) Able to understand and to apply in practice the requirements in the national legislation, regulations and Standards; and, d) Continuously undergo regular and further training to maintain this expertise.	
12.	Air-conditioner piping in the occupied space shall be installed in such a way to protect against accidental damage in operation and service.	
13.	Precautions shall be taken to avoid excessive vibration or pulsation to refrigerating piping.	
14.	Ensure protection devices, refrigerating piping and fittings are well protected against adverse environmental effects (such as the danger of water collecting and freezing in relief pipes or the accumulation of dirt and debris).	
15.	Expansion and contraction of long runs piping in refrigerating systems shall be designed and installed securely (mounted and guarded) to minimize the likelihood hydraulic shock damaging the system.	
16.	Protect the refrigerating system from accidental rupture due to moving furniture or reconstruction activities.	
17.	To ensure no leaking, field-made refrigerant joints indoors shall be tightness tested. The test method shall have a sensitivity of 5 grams per year of refrigerant or better under a pressure of at least 0,25 times the maximum allowable pressure (>1.04MPa, max 4.15MPa). No leak shall be detected.	

 CAUTION

General

1.
 - Must ensure the installation of pipe-work shall be kept to a minimum. Avoid use dented pipe and do not allow acute bending.
 - Must ensure that pipe-work shall be protected from physical damage.
 - Must comply with national gas regulations, state municipal rules and legislation. Notify relevant authorities in accordance with all applicable regulations.
 - Must ensure mechanical connections be accessible for maintenance purposes.
 - In cases that require mechanical ventilation, ventilation openings shall be kept clear of obstruction.
 - When disposal of the product, do follow to the precautions in #12 and comply with national regulations.
 - In case of field charge, the effect on refrigerant charge caused by the different pipe length has to be quantified, measured and labeled.
- Always contact to local municipal offices for proper handling.
- Ensure the actual refrigerant charge is in accordance with the room size within which the refrigerant containing parts are installed.
 - Ensure refrigerant charge not to leak.
 - Wear appropriate protective equipment, including respiratory protection, as conditions warrant.
 - Keep all sources of ignition and hot metal surfaces away.



Servicing

- 2-1. Qualification of workers
 - Any qualified person who is involved with working on or breaking into a refrigerant circuit should hold a current valid certificate from an industry-accredited assessment authority, which authorizes their competence to handle refrigerants safely in accordance with an industry recognised assessment specification.
 - Servicing shall only be performed as recommended by the equipment manufacturer. Maintenance and repair requiring the assistance of other skilled personnel shall be carried out under the supervision of the person competent in the use of flammable refrigerants.
 - Servicing shall be performed only as recommended by the manufacturer.
 - The system is inspected, regularly supervised and maintained by a trained and certified service personnel who is employed by the person user or party responsible.
- 2-2. Checks to the area
 - Prior to beginning work on systems containing flammable refrigerants, safety checks are necessary to ensure that the risk of ignition is minimised.

For repair to the refrigerating system, the precautions in #2-3 to #2-7 must be followed before conducting work on the system.
- 2-3. Work procedure
 - Work shall be undertaken under a controlled procedure so as to minimize the risk of a flammable gas or vapour being present while the work is being performed.
- 2-4. General work area
 - All maintenance staff and others working in the local area shall be instructed and supervised on the nature of work being carried out.
2.
 - Avoid working in confined spaces. Always ensure away from source, at least 2 meter of safety distance, or zoning of free space area of at least 2 meter in radius.
- 2-5. Checking for presence of refrigerant
 - The area shall be checked with an appropriate refrigerant detector prior to and during work, to ensure the technician is aware of potentially flammable atmospheres.
 - Ensure that the leak detection equipment being used is suitable for use with flammable refrigerants, i.e. non sparking, adequately sealed or intrinsically safe.
 - In case of leakage/spillage happened, immediately ventilate area and stay upwind and away from spill/release.
 - In case of leakage/spillage happened, do notify persons down wind of the leaking/spill, isolate immediate hazard area and keep unauthorized personnel out.
- 2-6. Presence of fire extinguisher
 - If any hot work is to be conducted on the refrigeration equipment or any associated parts, appropriate fire extinguishing equipment shall be available at hand.
 - Have a dry powder or CO₂ fire extinguisher adjacent to the charging area.
- 2-7. No ignition sources
 - No person carrying out work in relation to a refrigeration system which involves exposing any pipe work that contains or has contained flammable refrigerant shall use any sources of ignition in such a manner that it may lead to the risk of fire or explosion. He/She must not be smoking when carrying out such work.
 - All possible ignition sources, including cigarette smoking, should be kept sufficiently far away from the site of installation, repairing, removing and disposal, during which flammable refrigerant can possibly be released to the surrounding space.
 - Prior to work taking place, the area around the equipment is to be surveyed to make sure that there are no flammable hazards or ignition risks.
 - "No Smoking" signs shall be displayed.



 **CAUTION**

2-8. Ventilated area

- Ensure that the area is in the open or that it is adequately ventilated before breaking into the system or conducting any hot work.
- A degree of ventilation shall continue during the period that the work is carried out.
- The ventilation should safely disperse any released refrigerant and preferably expel it externally into the atmosphere.

2-9. Checks to the refrigeration equipment

- Where electrical components are being changed, they shall be fit for the purpose and to the correct specification.
- At all times the manufacturer's maintenance and service guidelines shall be followed.
- If in doubt consult the manufacturer's technical department for assistance.
- The following checks shall be applied to installations using flammable refrigerants.
 - The actual refrigerant charge is in accordance with the room size within which the refrigerant containing parts are installed.
 - The ventilation machinery and outlets are operating adequately and are not obstructed.
 - If an indirect refrigerating circuit is being used, the secondary circuit shall be checked for the presence of refrigerant.
 - Marking to the equipment continues to be visible and legible. Markings and signs that are illegible shall be corrected.
 - Refrigeration pipe or components are installed in a position where they are unlikely to be exposed to any substance which may corrode refrigerant containing components, unless the components are constructed of materials which are inherently resistant to being corroded or are properly protected against being so corroded.

2.

2-10. Checks to electrical devices

- Repair and maintenance to electrical components shall include initial safety checks and component inspection procedures.
- Initial safety checks shall include but not limit to:-
 - That capacitors are discharged: this shall be done in a safe manner to avoid possibility of sparking.
 - That there is no live electrical components and wiring are exposed while charging, recovering or purging the system.
 - That there is continuity of earth bonding.
- At all times the manufacturer's maintenance and service guidelines shall be followed.
- If in doubt consult the manufacturer's technical department for assistance.
- If a fault exists that could compromise safety, then no electrical supply shall be connected to the circuit until it is satisfactorily dealt with.
- If the fault cannot be corrected immediately but it is necessary to continue operation, an adequate temporary solution shall be used.
- The owner of the equipment must be informed or reported so all parties are advised thereafter.

Repairs to sealed components

- During repairs to sealed components, all electrical supplies shall be disconnected from the equipment being worked upon prior to any removal of sealed covers, etc.
 - If it is absolutely necessary to have an electrical supply to equipment during servicing, then a permanently operating form of leak detection shall be located at the most critical point to warn of a potentially hazardous situation.
 - Particular attention shall be paid to the following to ensure that by working on electrical components, the casing is not altered in such a way that the level of protection is affected. This shall include damage to cables, excessive number of connections, terminals not made to original specification, damage to seals, incorrect fitting of glands, etc.
- 3.
- Ensure that apparatus is mounted securely.
 - Ensure that seals or sealing materials have not degraded such that they no longer serve the purpose of preventing the ingress of flammable atmospheres.
 - Replacement parts shall be in accordance with the manufacturer's specifications.

NOTE: The use of silicon sealant may inhibit the effectiveness of some types of leak detection equipment. Intrinsicly safe components do not have to be isolated prior to working on them.

Repair to intrinsically safe components

- Do not apply any permanent inductive or capacitance loads to the circuit without ensuring that this will not exceed the permissible voltage and current permitted for the equipment in use.
- 4.
- Intrinsically safe components are the only types that can be worked on while live in the presence of a flammable atmosphere.
 - The test apparatus shall be at the correct rating.
 - Replace components only with parts specified by the manufacturer. Unspecified parts by manufacturer may result ignition of refrigerant in the atmosphere from a leak.

Cabling

- 5.
- Check that cabling will not be subject to wear, corrosion, excessive pressure, vibration, sharp edges or any other adverse environmental effects.
 - The check shall also take into account the effects of aging or continual vibration from sources such as compressors or fans.

 CAUTION

Detection of flammable refrigerants

- Under no circumstances shall potential sources of ignition be used in the searching or detection of refrigerant leaks.
 - A halide torch (or any other detector using a naked flame) shall not be used.
 - The following leak detection methods are deemed acceptable for all refrigerant systems.
 - No leaks shall be detected when using detection equipment with a sensitivity of 5 grams per year of refrigerant or better under a pressure of at least 0,25 times the maximum allowable pressure (>1.04MPa, max 4.15MPa) for example, a universal sniffer.
 - Electronic leak detectors may be used to detect flammable refrigerants, but the sensitivity may not be adequate, or may need re-calibration.
(Detection equipment shall be calibrated in a refrigerant-free area.)
- 6.
- Ensure that the detector is not a potential source of ignition and is suitable for the refrigerant used.
 - Leak detection equipment shall be set at a percentage of the LFL of the refrigerant and shall be calibrated to the refrigerant employed and the appropriate percentage of gas (25 % maximum) is confirmed.
 - Leak detection fluids are suitable for use with most refrigerants, for example, bubble method and fluorescent method agents. The use of detergents containing chlorine shall be avoided as the chlorine may react with the refrigerant and corrode the copper pipe-work.
 - If a leak is suspected, all naked flames shall be removed/extinguished.
 - If a leakage of refrigerant is found which requires brazing, all of the refrigerant shall be recovered from the system, or isolated (by means of shut off valves) in a part of the system remote from the leak. The precautions in #7 must be followed to remove the refrigerant.



Removal and evacuation

- When breaking into the refrigerant circuit to make repairs – or for any other purpose – conventional procedures shall be used. However, it is important that best practice is followed since flammability is a consideration. The following procedure shall be adhered to:

- remove refrigerant ->
- purge the circuit with inert gas ->
- evacuate ->
- purge with inert gas ->
- open the circuit by cutting or brazing

- 7.
- The refrigerant charge shall be recovered into the correct recovery cylinders.
 - The system shall be purged with OFN to render the appliance safe. (remark: OFN = oxygen free nitrogen, type of inert gas)
 - This process may need to be repeated several times.
 - Compressed air or oxygen shall not be used for this task.
 - Purging shall be achieved by breaking the vacuum in the system with OFN and continuing to fill until the working pressure is achieved, then venting to atmosphere, and finally pulling down to a vacuum.
 - This process shall be repeated until no refrigerant is within the system.
 - When the final OFN charge is used, the system shall be vented down to atmospheric pressure to enable work to take place.
 - This operation is absolutely vital if brazing operations on the pipe work are to take place.
 - Ensure that the outlet for the vacuum pump is not close to any potential ignition sources and there is ventilation available.



Charging procedures

- In addition to conventional charging procedures, the following requirements shall be followed.
 - Ensure that contamination of different refrigerants does not occur when using charging equipment.
 - Hoses or lines shall be as short as possible to minimize the amount of refrigerant contained in them.
 - Cylinders shall be kept in an appropriate position according to the instruction.
 - Ensure that the refrigeration system is earthed prior to charging the system with refrigerant.
 - Label the system when charging is complete (if not already).
- 8.
- Extreme care shall be taken not to over fill the refrigeration system.
 - Prior to recharging the system it shall be pressure tested with OFN (refer to #7).
 - The system shall be leak tested on completion of charging but prior to commissioning.
 - A follow up leak test shall be carried out prior to leaving the site.
 - Electrostatic charge may accumulate and create a hazardous condition when charging and discharging the refrigerant. To avoid fire or explosion, dissipate static electricity during transfer by grounding and bonding containers and equipment before charging/discharging.



 CAUTION

Decommissioning

- Before carrying out this procedure, it is essential that the technician is completely familiar with the equipment and all its details.
- It is recommended good practice that all refrigerants are recovered safely.
- Prior to the task being carried out, an oil and refrigerant sample shall be taken in case analysis is required prior to re-use of recovered refrigerant.
- It is essential that electrical power is available before the task is commenced.
 - a) Become familiar with the equipment and its operation.
 - b) Isolate system electrically.
 - c) Before attempting the procedure ensure that:

- mechanical handling equipment is available, if required, for handling refrigerant cylinders;
- all personal protective equipment is available and being used correctly;
- the recovery process is supervised at all times by a competent person;
- recovery equipment and cylinders conform to the appropriate standards.

9.

- d) Pump down refrigerant system, if possible.
 - e) If a vacuum is not possible, make a manifold so that refrigerant can be removed from various parts of the system.
 - f) Make sure that cylinder is situated on the scales before recovery takes place.
 - g) Start the recovery machine and operate in accordance with manufacturer's instructions.
 - h) Do not over fill cylinders. (No more than 80 % volume liquid charge).
 - i) Do not exceed the maximum working pressure of the cylinder, even temporarily.
 - j) When the cylinders have been filled correctly and the process completed, make sure that the cylinders and the equipment are removed from site promptly and all isolation valves on the equipment are closed off.
 - k) Recovered refrigerant shall not be charged into another refrigeration system unless it has been cleaned and checked.
- Electrostatic charge may accumulate and create a hazardous condition when charging or discharging the refrigerant. To avoid fire or explosion, dissipate static electricity during transfer by grounding and bonding containers and equipment before charging/discharging.

Labelling

10.
 - Equipment shall be labelled stating that it has been de-commissioned and emptied of refrigerant.
 - The label shall be dated and signed.
 - Ensure that there are labels on the equipment stating the equipment contains flammable refrigerant.

Recovery

11.
 - When removing refrigerant from a system, either for servicing or decommissioning, it is recommended good practice that all refrigerants are removed safely.
 - When transferring refrigerant into cylinders, ensure that only appropriate refrigerant recovery cylinders are employed.
 - Ensure that the correct number of cylinders for holding the total system charge are available.
 - All cylinders to be used are designated for the recovered refrigerant and labelled for that refrigerant (i.e. special cylinders for the recovery of refrigerant).
 - Cylinders shall be complete with pressure relief valve and associated shut-off valves in good working order.
 - Recovery cylinders are evacuated and, if possible, cooled before recovery occurs.
 - The recovery equipment shall be in good working order with a set of instructions concerning the equipment that is at hand and shall be suitable for the recovery of concerning the equipment that is at hand and shall be suitable for the recovery of flammable refrigerants.
11.
 - In addition, a set of calibrated weighing scales shall be available and in good working order.
 - Hoses shall be complete with leak-free disconnect couplings and in good condition.
 - Before using the recovery machine, check that it is in satisfactory working order, has been properly maintained and that any associated electrical components are sealed to prevent ignition in the event of a refrigerant release. Consult manufacturer if in doubt.
 - The recovered refrigerant shall be returned to the refrigerant supplier in the correct recovery cylinder, and the relevant Waste Transfer Note arranged.
 - Do not mix refrigerants in recovery units and especially not in cylinders.
 - If compressors or compressor oils are to be removed, ensure that they have been evacuated to an acceptable level to make certain that flammable refrigerant does not remain within the lubricant.
 - The evacuation process shall be carried out prior to returning the compressor to the suppliers.
 - Only electric heating to the compressor body shall be employed to accelerate this process.
 - When oil is drained from a system, it shall be carried out safely.

3. Specification

Model		Indoor	CS-HZ25XKE / CS-HZ25XKE-5			
		Outdoor	CU-HZ25XKE / CU-HZ25XKE-5			
Performance Test Condition		EUROVENT				
Power Supply		Phase, Hz	Single, 50			
		V	230			
		Min.	Mid.	Max.		
Cooling	Capacity	kW	0.85	2.50	3.00	
		BTU/h	2900	8530	10200	
		kcal/h	730	2150	2580	
	Running Current	A	–	2.10	–	
	Input Power	W	170	455	670	
	Annual Consumption	kWh	–	228	–	
	EER	W/W	5.00	5.49	4.48	
		BTU/hW	17.06	18.75	15.22	
		kcal/hW	4.29	4.73	3.85	
	ErP	Pdesign	kW	2.5		
		SEER	(W/W)	8.7		
		Annual Consumption	kWh	101		
		Class		A+++		
	Power Factor	%	–	94	–	
	Indoor Noise (H / L / QLo)	dB(A)	44 / 25 / 20			
		Power Level dB(A)	60 / - / -			
Outdoor Noise (H / L / QLo)	dB(A)	46 / - / 43				
	Power Level dB(A)	61 / - / -				
Heating	Capacity	kW	0.85	3.20	7.50	
		BTU/h	2900	10900	25600	
		kcal/h	730	2750	6450	
	Running Current	A	–	2.60	–	
	Input Power	W	165	570	2.16k	
	COP	W/W	5.15	5.61	3.47	
		BTU/hW	17.58	19.12	11.85	
		kcal/hW	4.42	4.82	2.99	
	ErP	Pdesign	kW	3.0		
		Tbivalent	°C	-10		
		SCOP	(W/W)	5.3		
		Annual Consumption	kWh	792		
		Class		A+++		
	Power Factor	%	–	95	–	
	Indoor Noise (H / L / QLo)	dB(A)	45 / 24 / 18			
		Power Level dB(A)	61 / - / -			
Outdoor Noise (H / L / QLo)	dB(A)	47 / - / 44				
	Power Level dB(A)	62 / - / -				
Low Temp. : Capacity (kW) / I.Power (W) / COP		5.43 / 1.91k / 2.84				
Extr Low Temp. : Capacity (kW) / I.Power (W) / COP		5.00 / 1.94k / 2.58				
Max Current (A) / Max Input Power (W)		9.4 / 2.16k				
Starting Current (A)		2.60				
Compressor	Type	Hermetic Motor (Rotary)				
	Motor Type	Brushless (6 poles)				
	Output Power	W	900			

Model			Indoor	CS-HZ25XKE / CS-HZ25XKE-5	
			Outdoor	CU-HZ25XKE / CU-HZ25XKE-5	
Indoor Fan	Type			Cross-Flow Fan	
	Material			ASG30	
	Motor Type			DC / Transistor (8-poles)	
	Input Power		W	47.1	
	Output Power		W	30	
	Speed	QLo	Cool	rpm	530
			Heat	rpm	500
		Lo	Cool	rpm	610
			Heat	rpm	620
		Me	Cool	rpm	850
			Heat	rpm	900
		Hi	Cool	rpm	1090
			Heat	rpm	1190
SHi	Cool	rpm	1160		
	Heat	rpm	1260		
Outdoor Fan	Type			Propeller Fan	
	Material			PP	
	Motor Type			DC Motor (8-poles)	
	Input Power		W	-	
	Output Power		W	40	
	Speed	Hi	Cool	rpm	840
			Heat	rpm	840
Moisture Removal		L/h (Pt/h)		1.5 (3.2)	
Indoor Airflow	QLo	Cool	m ³ /min (ft ³ /min)	5.30 (190)	
		Heat	m ³ /min (ft ³ /min)	4.83 (170)	
	Lo	Cool	m ³ /min (ft ³ /min)	6.56 (235)	
		Heat	m ³ /min (ft ³ /min)	6.72 (240)	
	Me	Cool	m ³ /min (ft ³ /min)	10.34 (365)	
		Heat	m ³ /min (ft ³ /min)	11.13 (395)	
	Hi	Cool	m ³ /min (ft ³ /min)	14.10 (500)	
		Heat	m ³ /min (ft ³ /min)	15.70 (555)	
SHi	Cool	m ³ /min (ft ³ /min)	15.22 (540)		
	Heat	m ³ /min (ft ³ /min)	16.80 (595)		
Outdoor Airflow	Hi	Cool	m ³ /min (ft ³ /min)	32.70 (1155)	
		Heat	m ³ /min (ft ³ /min)	32.70 (1155)	
Refrigeration Cycle	Control Device			Expansion Valve	
	Refrigerant Oil		cm ³	FW50S (450)	
	Refrigerant Type		g (oz)	R32, 1.06k (37.4)	
F-Gas	GWP			675	
	PRECHARGED AMOUNT / MAXIMUM CHARGE AMOUNT		CO2eq (ton)	0.72 / 0.80	
Dimension	Height (I/D / O/D)		mm (inch)	295 (11-5/8) / 622 (24-1/2)	
	Width (I/D / O/D)		mm (inch)	870 (34-9/32) / 824 (32-15/32)	
	Depth (I/D / O/D)		mm (inch)	229 (9-1/32) / 299 (11-25/32)	
Weight	Net (I/D / O/D)		kg (lb)	11 (24) / 34 (75)	
Piping	Pipe Diameter (Liquid / Gas)		mm (inch)	6.35 (1/4) / 9.52 (3/8)	
	Standard length		m (ft)	5.0 (16.4)	
	Length range (min – max)		m (ft)	3 (9.8) ~ 20 (65.6)	
	I/D & O/D Height different		m (ft)	10.0 (32.8)	
	Additional Gas Amount		g/m (oz/ft)	10 (0.1)	
	Length for Additional Gas		m (ft)	7.5 (24.6)	

Model		Indoor	CS-HZ25XKE / CS-HZ25XKE-5	
		Outdoor	CU-HZ25XKE / CU-HZ25XKE-5	
Drain Hose	Inner Diameter	mm	16	
	Length	mm	650	
Indoor Heat Exchanger	Fin Material		Aluminium (Pre Coat)	
	Fin Type		Slit Fin	
	Row × Stage × FPI		2 × 17 × 21, Sub Eva × 2 : 1 × 4 × 21	
	Size (W × H × L)	mm	644.5 × 357 × 25.4, Sub Eva × 2 : 644.5 × 94.8 × 12.7	
Outdoor Heat Exchanger	Fin Material		Aluminium (Pre Coat) / Aluminium (Blue Fin)	
	Fin Type		Corrugate Fin	
	Row × Stage × FPI		2 × 28 × 19	
	Size (W × H × L)	mm	36.4 × 588 × 856.3:827.7	
Air Filter	Material		Polypropelene	
	Type		One-touch	
Power Supply			Indoor / Outdoor	
Power Supply Cord		A	Nil	
Thermostat			Electronic Control	
Protection Device			Electronic Control	
			Dry Bulb	Wet Bulb
Indoor Operation Range	Cooling	Maximum °C (°F)	32 (89.6)	23 (73.4)
		Minimum °C (°F)	16 (60.8)	11 (51.8)
	Heating	Maximum °C (°F)	30 (86.0)	–
		Minimum °C (°F)	16 (60.8)	–
	+8/15°C HEAT	Maximum °C (°F)	15 (59.0)	–
		Minimum °C (°F)	8 (46.4)	–
Outdoor Operation Range	Cooling	Maximum °C (°F)	43 (109.4)	26 (78.8)
		Minimum °C (°F)	16 (60.8)	11 (51.8)
	Heating	Maximum °C (°F)	24 (75.2)	18 (64.4)
		Minimum °C (°F)	-25 (-13.0)	–
	+8/15°C HEAT	Maximum °C (°F)	–	–
		Minimum °C (°F)	-25 (-13.0)	–

- Cooling capacities are based on indoor temperature of 27°C Dry Bulb (80.6°F Dry Bulb), 19.0°C Wet Bulb (66.2°F Wet Bulb) and outdoor air temperature of 35°C Dry Bulb (95°F Dry Bulb), 24°C Wet Bulb (75.2°F Wet Bulb)
- Heating capacities are based on indoor temperature of 20°C Dry Bulb (68°F Dry Bulb) and outdoor air temperature of 7°C Dry Bulb (44.6°F Dry Bulb), 6°C Wet Bulb (42.8°F Wet Bulb)
- Heating low temperature capacity, Input Power and COP measured at 230 V, indoor temperature 20°C, outdoor 2/1°C.
- Heating extreme low temperature capacity, Input Power and COP measured at 230 V, indoor temperature 20°C, outdoor -7/-8°C.
- Specifications are subjected to change without prior notice for further improvement.
- Maximum heating capacity shown are the values based on powerful operation.
- If the EUROVENT Certified models can be operated under the "extra-low" temperature condition, -7°C DB and -8°C WB temperature with rated voltage 230V shall be used.
- The annual consumption is calculated by multiplying the input power by an average of 500 hours per year in cooling mode.
- SEER and SCOP classification is at 230V only in accordance with EN-14825. For heating, SCOP indicates the value of only Average heating season.

Model		Indoor	CS-HZ35XKE				
		Outdoor	CU-HZ35XKE				
Performance Test Condition			EUROVENT				
Power Supply		Phase, Hz	Single, 50				
		V	230				
			Min.	Mid.	Max.		
Cooling	Capacity		kW	0.85	3.50	4.00	
			BTU/h	2900	11900	13600	
			kcal/h	730	3010	3440	
	Running Current		A	-	3.50	-	
	Input Power		W	170	800	990	
	Annual Consumption		kWh	-	400	-	
	EER		W/W	5.00	4.38	4.04	
			BTU/hW	17.06	14.88	13.74	
			kcal/hW	4.29	3.76	3.47	
	ErP	Pdesign		kW	3.5		
		SEER		(W/W)	8.5		
		Annual Consumption		kWh	144		
		Class			A+++		
	Power Factor		%	-	99	-	
	Indoor Noise (H / L / QLo)		dB(A)		44 / 28 / 20		
			Power Level dB(A)		60 / - / -		
	Outdoor Noise (H / L / QLo)		dB(A)		48 / - / 45		
			Power Level dB(A)		63 / - / -		
	Heating	Capacity		kW	0.85	4.20	7.90
				BTU/h	2900	14300	26900
kcal/h				730	3610	6790	
Running Current		A	-	3.80	-		
Input Power		W	165	840	2.25k		
COP		W/W	5.15	5.00	3.51		
		BTU/hW	17.58	17.02	11.96		
		kcal/hW	4.42	4.30	3.02		
ErP		Pdesign		kW	4.0		
		Tbivalent		°C	-10		
		SCOP		(W/W)	5.3		
		Annual Consumption		kWh	1057		
		Class			A+++		
Power Factor		%	-	96	-		
Indoor Noise (H / L / QLo)		dB(A)		45 / 25 / 18			
		Power Level dB(A)		61 / - / -			
Outdoor Noise (H / L / QLo)		dB(A)		50 / - / 47			
		Power Level dB(A)		65 / - / -			
Low Temp. : Capacity (kW) / I.Power (W) / COP			5.72 / 1.99k / 2.87				
Extr Low Temp. : Capacity (kW) / I.Power (W) / COP			5.12 / 2.00k / 2.56				
Max Current (A) / Max Input Power (W)			9.8 / 2.25k				
Starting Current (A)			3.80				
Compressor	Type		Hermetic Motor (Rotary)				
	Motor Type		Brushless (6-poles)				
	Output Power		W	900			

Model			Indoor	CS-HZ35XKE	
			Outdoor	CU-HZ35XKE	
Indoor Fan	Type			Cross-flow Fan	
	Material			ASG30	
	Motor Type			DC / Transistor (8-poles)	
	Input Power		W	47.1	
	Output Power		W	30	
	Speed	QLo	Cool	rpm	530
			Heat	rpm	500
		Lo	Cool	rpm	670
			Heat	rpm	640
		Me	Cool	rpm	870
			Heat	rpm	920
		Hi	Cool	rpm	1090
			Heat	rpm	1190
	SHi	Cool	rpm	1160	
Heat		rpm	1260		
Outdoor Fan	Type			Propeller Fan	
	Material			PP	
	Motor Type			DC Motor (8-poles)	
	Input Power		W	-	
	Output Power		W	40	
	Speed	Hi	Cool	rpm	860
			Heat	rpm	860
Moisture Removal			L/h (Pt/h)	2.0 (4.2)	
Indoor Airflow	QLo	Cool	m ³ /min (ft ³ /min)	5.30 (190)	
		Heat	m ³ /min (ft ³ /min)	4.83 (170)	
	Lo	Cool	m ³ /min (ft ³ /min)	7.50 (265)	
		Heat	m ³ /min (ft ³ /min)	7.03 (250)	
	Me	Cool	m ³ /min (ft ³ /min)	10.65 (380)	
		Heat	m ³ /min (ft ³ /min)	11.44 (405)	
	Hi	Cool	m ³ /min (ft ³ /min)	14.10 (500)	
		Heat	m ³ /min (ft ³ /min)	15.70 (555)	
SHi	Cool	m ³ /min (ft ³ /min)	15.22 (540)		
	Heat	m ³ /min (ft ³ /min)	16.80 (595)		
Outdoor Airflow	Hi	Cool	m ³ /min (ft ³ /min)	34.40 (1215)	
		Heat	m ³ /min (ft ³ /min)	34.40 (1215)	
Refrigeration Cycle	Control Device			Expansion Valve	
	Refrigerant Oil		cm ³	FW50S (450)	
	Refrigerant Type		g (oz)	R32, 1.06k (37.4)	
F-Gas	GWP			675	
	PRECHARGED AMOUNT / MAXIMUM CHARGE AMOUNT		CO2eq (ton)	0.72 / 0.80	
Dimension	Height (I/D / O/D)		mm (inch)	295 (11-5/8) / 622 (24-1/2)	
	Width (I/D / O/D)		mm (inch)	870 (34-9/32) / 824 (32-15/32)	
	Depth (I/D / O/D)		mm (inch)	229 (9-1/32) / 299 (11-25/32)	
Weight	Net (I/D / O/D)		kg (lb)	11 (24) / 34 (75)	
Piping	Pipe Diameter (Liquid / Gas)		mm (inch)	6.35 (1/4) / 9.52 (3/8)	
	Standard length		m (ft)	5.0 (16.4)	
	Length range (min – max)		m (ft)	3 (9.8) ~ 20 (65.6)	
	I/D & O/D Height different		m (ft)	10.0 (32.8)	
	Additional Gas Amount		g/m (oz/ft)	10 (0.1)	
	Length for Additional Gas		m (ft)	7.5 (24.6)	

Model		Indoor	CS-HZ35XKE	
		Outdoor	CU-HZ35XKE	
Drain Hose	Inner Diameter	mm	16	
	Length	mm	650	
Indoor Heat Exchanger	Fin Material		Aluminium (Pre Coat)	
	Fin Type		Slit Fin	
	Row × Stage × FPI		2 × 17 × 21, Sub Eva × 2 : 1 × 4 × 21	
	Size (W × H × L)	mm	644.5 × 357 × 25.4, Sub Eva × 2 : 644.5 × 94.8 × 12.7	
Outdoor Heat Exchanger	Fin Material		Aluminium (Pre Coat)	
	Fin Type		Corrugate Fin	
	Row × Stage × FPI		2 × 28 × 19	
	Size (W × H × L)	mm	36.4 × 588 × 856.3:827.7	
Air Filter	Material		Polypropelene	
	Type		One-touch	
Power Supply			Indoor / Outdoor	
Power Supply Cord		A	Nil	
Thermostat			Electronic Control	
Protection Device			Electronic Control	
			Dry Bulb	Wet Bulb
Indoor Operation Range	Cooling	Maximum °C (°F)	32 (89.6)	23 (73.4)
		Minimum °C (°F)	16 (60.8)	11 (51.8)
	Heating	Maximum °C (°F)	30 (86.0)	–
		Minimum °C (°F)	16 (60.8)	–
	+8/15°C HEAT	Maximum °C (°F)	15 (59.0)	–
		Minimum °C (°F)	8 (46.4)	–
Outdoor Operation Range	Cooling	Maximum °C (°F)	43 (109.4)	26 (78.8)
		Minimum °C (°F)	16 (60.8)	11 (51.8)
	Heating	Maximum °C (°F)	24 (75.2)	18 (64.4)
		Minimum °C (°F)	-25 (-13.0)	–
	+8/15°C HEAT	Maximum °C (°F)	–	–
		Minimum °C (°F)	-25 (-13.0)	–

- Cooling capacities are based on indoor temperature of 27°C Dry Bulb (80.6°F Dry Bulb), 19.0°C Wet Bulb (66.2°F Wet Bulb) and outdoor air temperature of 35°C Dry Bulb (95°F Dry Bulb), 24°C Wet Bulb (75.2°F Wet Bulb)
- Heating capacities are based on indoor temperature of 20°C Dry Bulb (68°F Dry Bulb) and outdoor air temperature of 7°C Dry Bulb (44.6°F Dry Bulb), 6°C Wet Bulb (42.8°F Wet Bulb)
- Heating low temperature capacity, Input Power and COP measured at 230 V, indoor temperature 20°C, outdoor 2/1°C.
- Heating extreme low temperature capacity, Input Power and COP measured at 230 V, indoor temperature 20°C, outdoor -7/-8°C.
- Specifications are subjected to change without prior notice for further improvement.
- Maximum heating capacity shown are the values based on powerful operation.
- If the EUROVENT Certified models can be operated under the "extra-low" temperature condition, -7°C DB and -8°C WB temperature with rated voltage 230V shall be used.
- The annual consumption is calculated by multiplying the input power by an average of 500 hours per year in cooling mode.
- SEER and SCOP classification is at 230V only in accordance with EN-14825. For heating, SCOP indicates the value of only Average heating season.

4. Features

- Inverter Technology
 - Wider output power range
 - Energy saving
 - More precise temperature control
- Environment Protection
 - Non-ozone depletion substances refrigerant (R32)
- Long Installation Piping
 - Long piping up to 20 meters
- Easy to use remote control
- Quality Improvement
 - Random auto restart after power failure for safety restart operation
 - Gas leakage protection
 - Prevent compressor reverse cycle
 - Inner protector to protect Compressor
 - Noise prevention during soft dry operation
- Operation Improvement
 - Quiet mode to reduce the indoor/outdoor unit operating sound
 - Powerful mode to reach the desired room temperature quickly
 - 24-hour timer setting
 - +8/15°C HEAT operation is designed to provide heating at low temperature settings. It is used in houses unoccupied during winter, for the purpose of protecting equipment or housing appliances which may be destroyed by extreme cold weather
 - nanoe™X operation provides clean air, moisturises your skin and hair, deodorizes odours in the room.
- Serviceability Improvement
 - Breakdown Self Diagnosis function
- Communications network

5. Location of Controls and Components

5.1 Indoor Unit

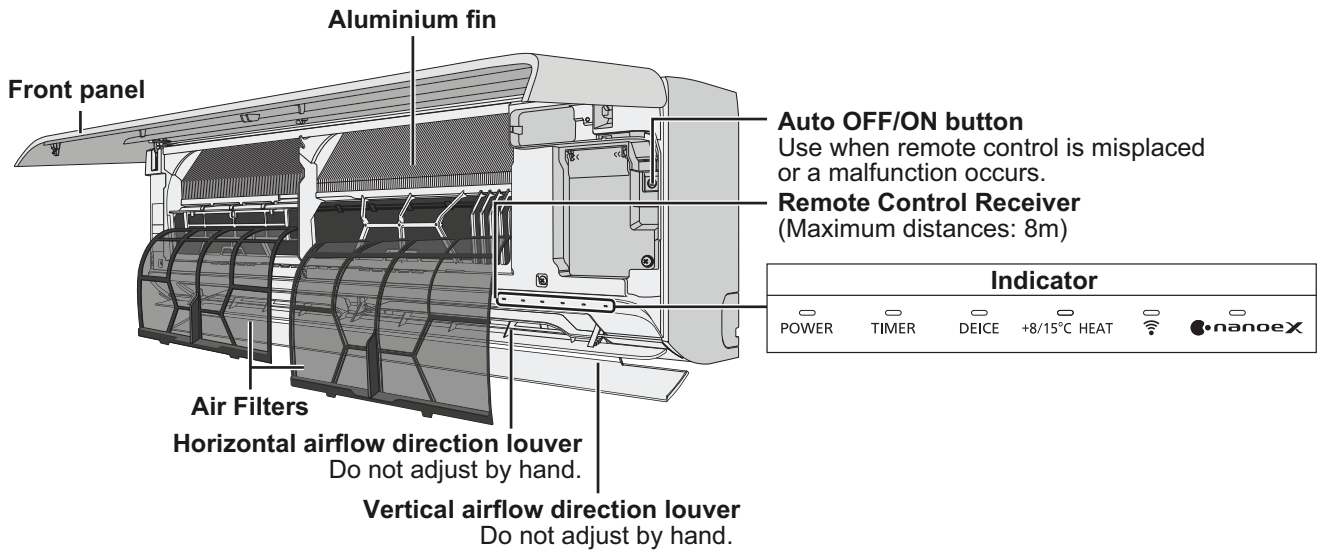

5.2 Outdoor Unit

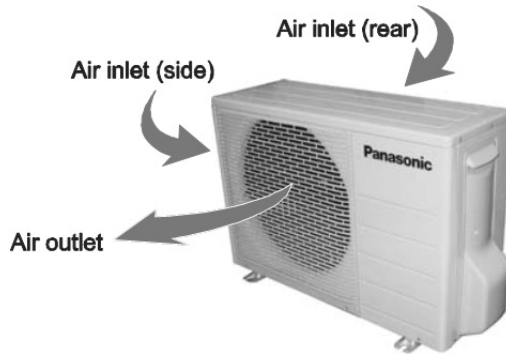

5.3 Remote Control

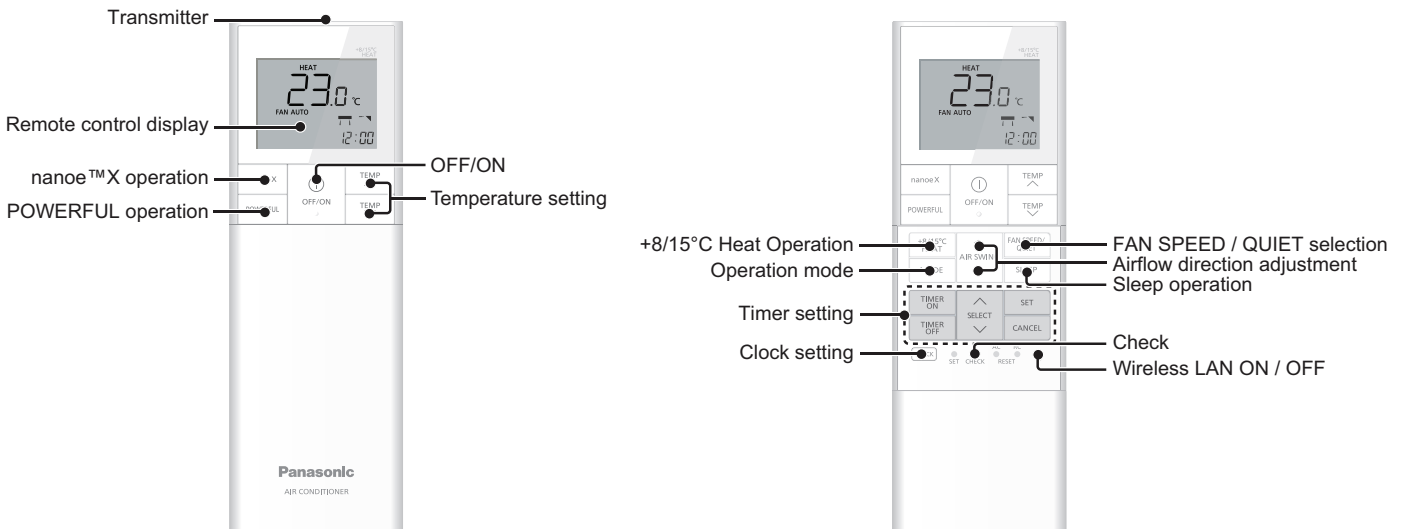

6. Dimensions

6.1 Indoor Unit

<Top View>

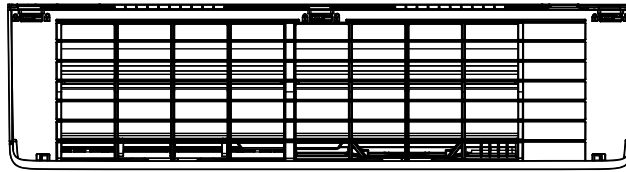

<Side View>

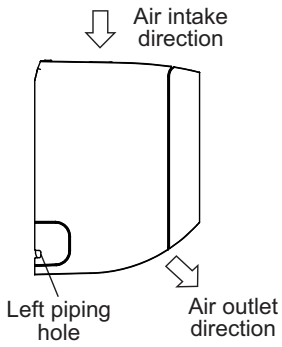

<Front View>

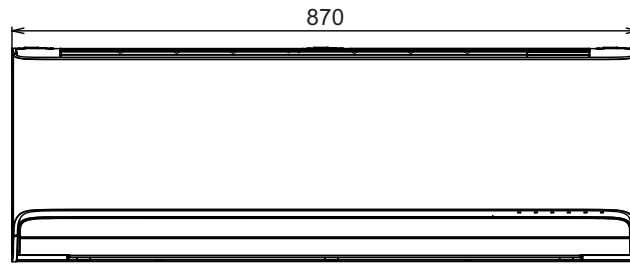

<Side View>

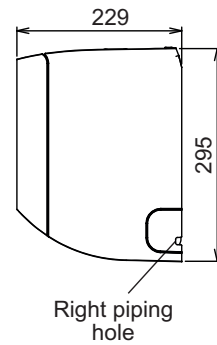

<Bottom View>

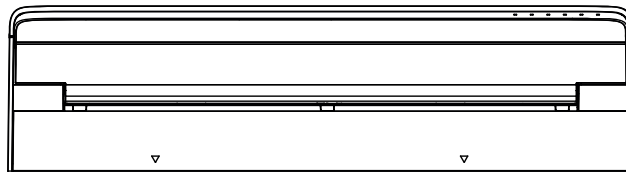

<Remote Control>

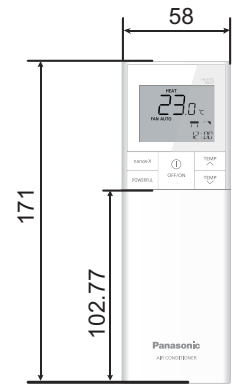

<Rear View>

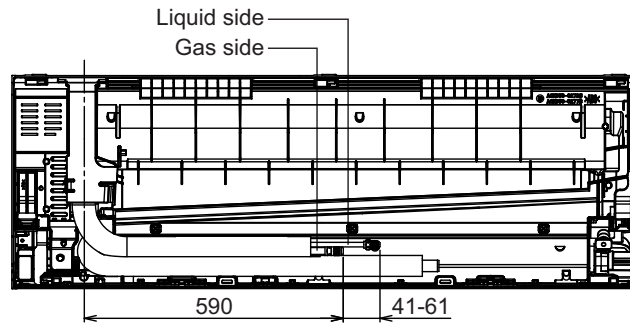

<Remote Control Holder>

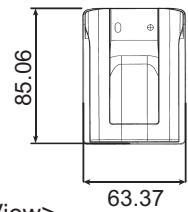

Relative position between the indoor unit and the installation plate <Front View>

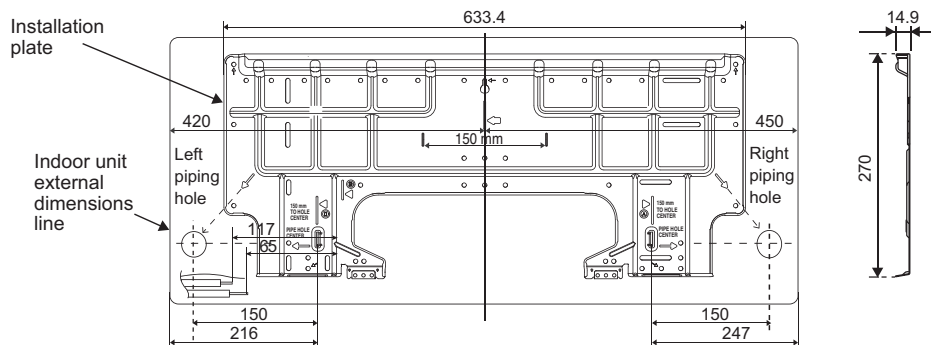

Unit: mm

6.2 Outdoor Unit

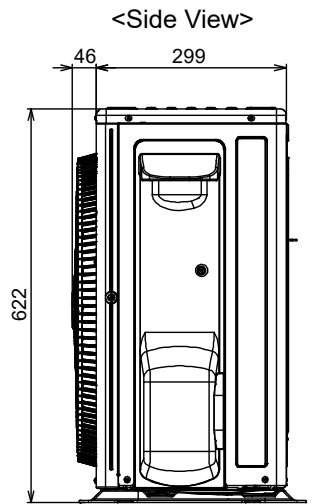
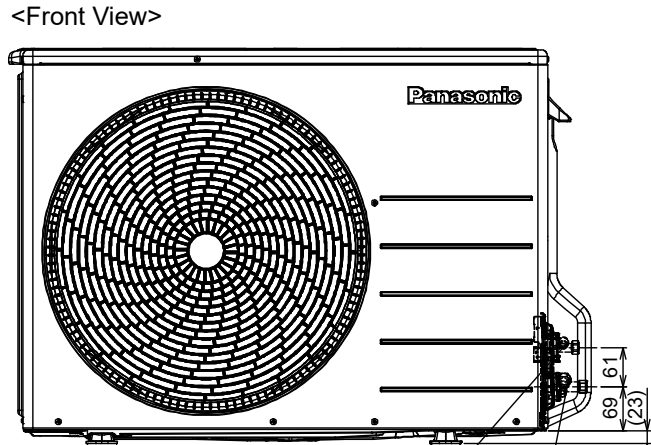
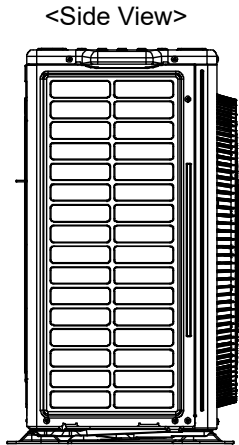
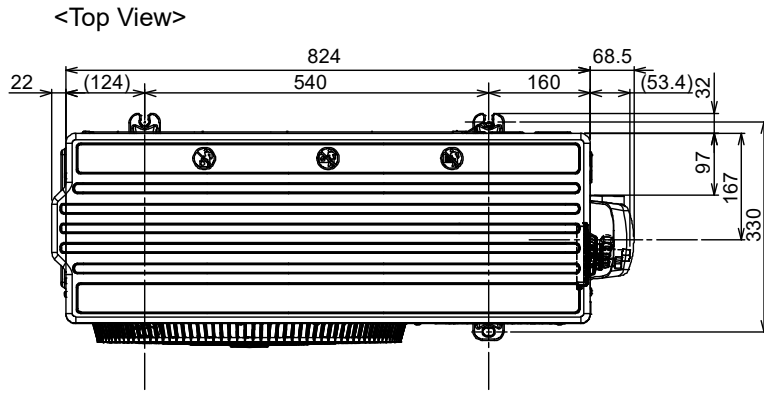
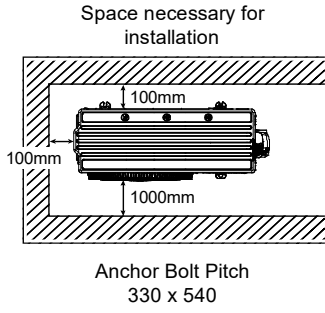

Unit : mm

3-way valve at Gas side
(Low Pressure)
2-way valve at Liquid side
(High Pressure)

7. Refrigeration Cycle Diagram

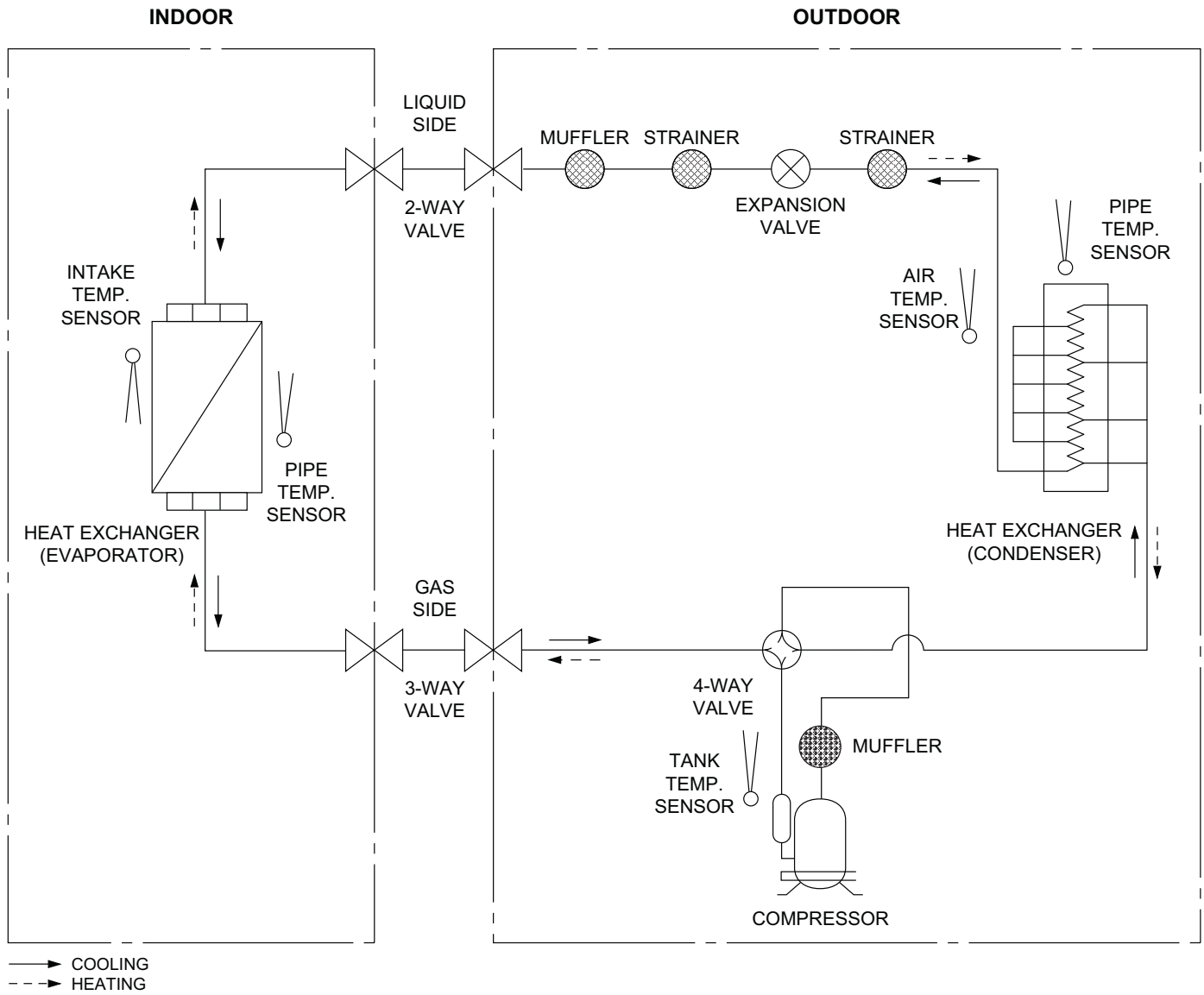

8. Block Diagram

8.1 Indoor Power Supply Connection

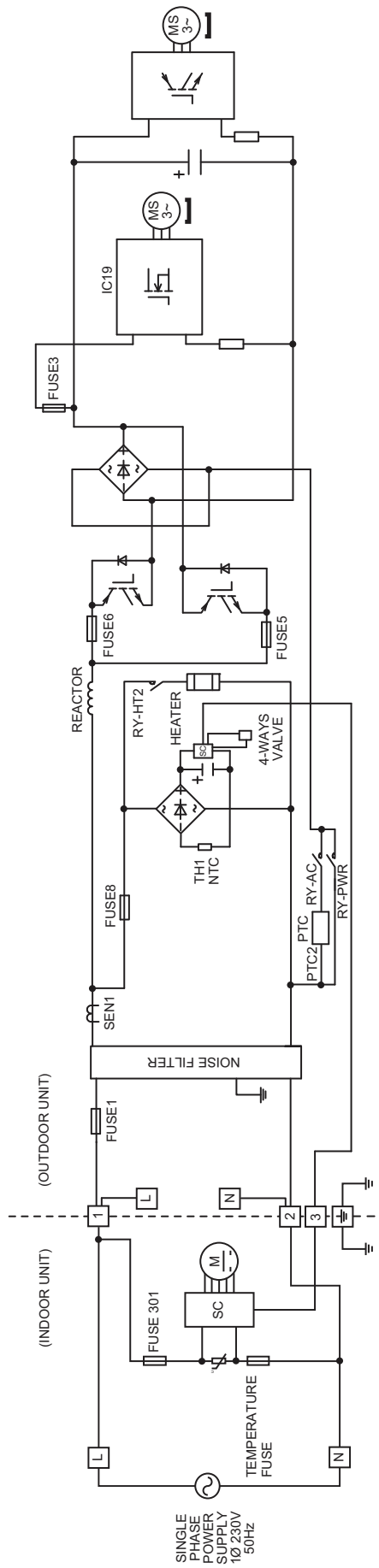

8.2 Outdoor Power Supply Connection

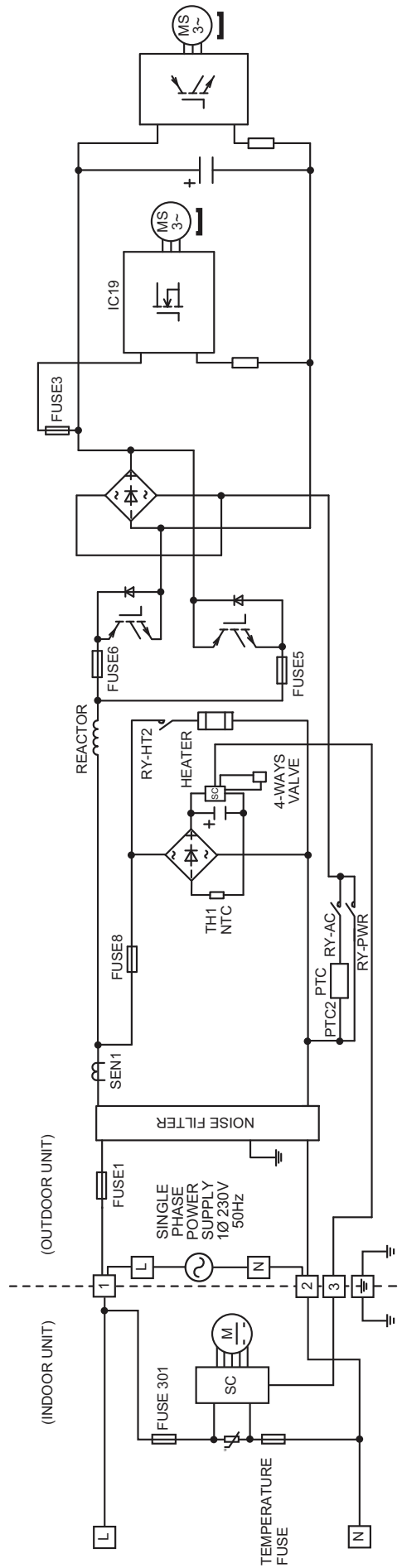

9.2 Outdoor Unit

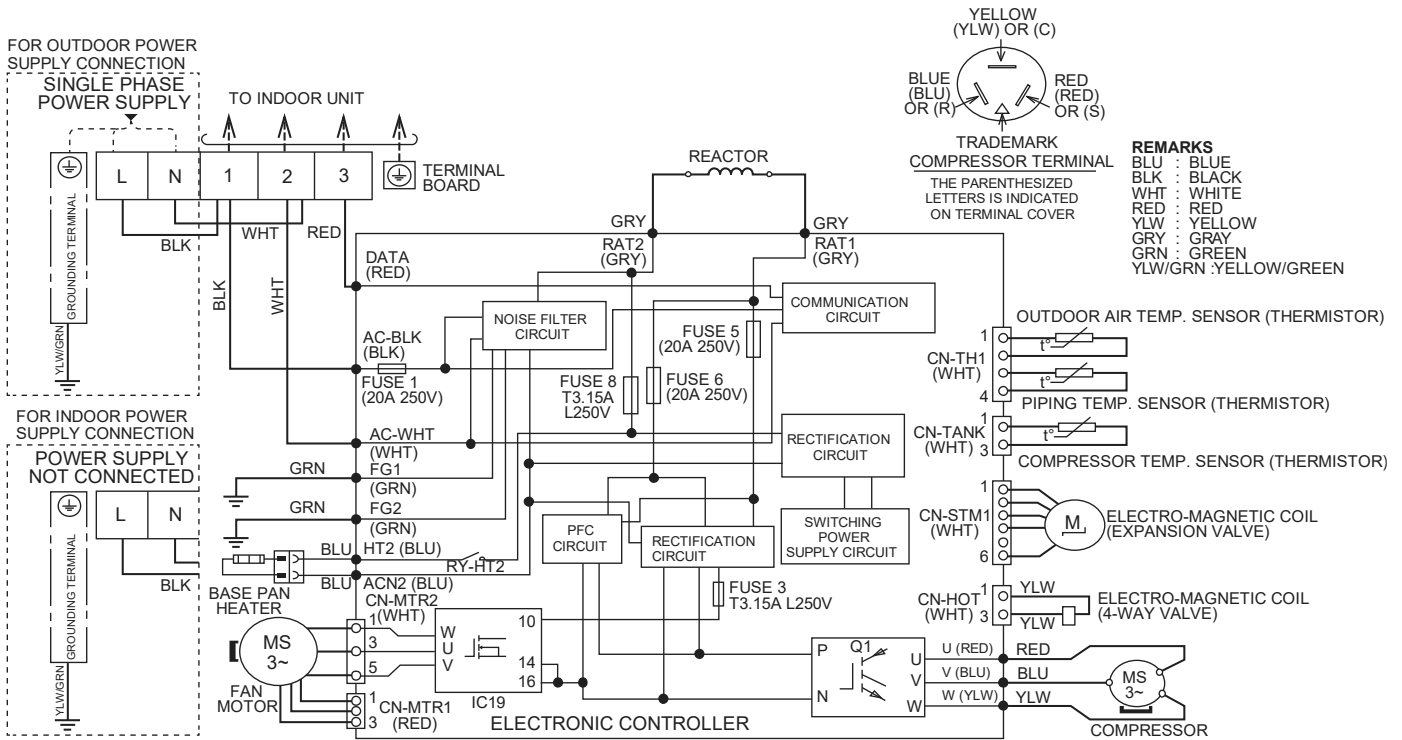

Resistance of Compressor Windings

CONNECTION	9RD132XGB21
U - V	1.708Ω
U - W	1.708Ω
V - W	1.708Ω

Winding resistance at 20°C.

10. Electronic Circuit Diagram

10.1 Indoor Unit

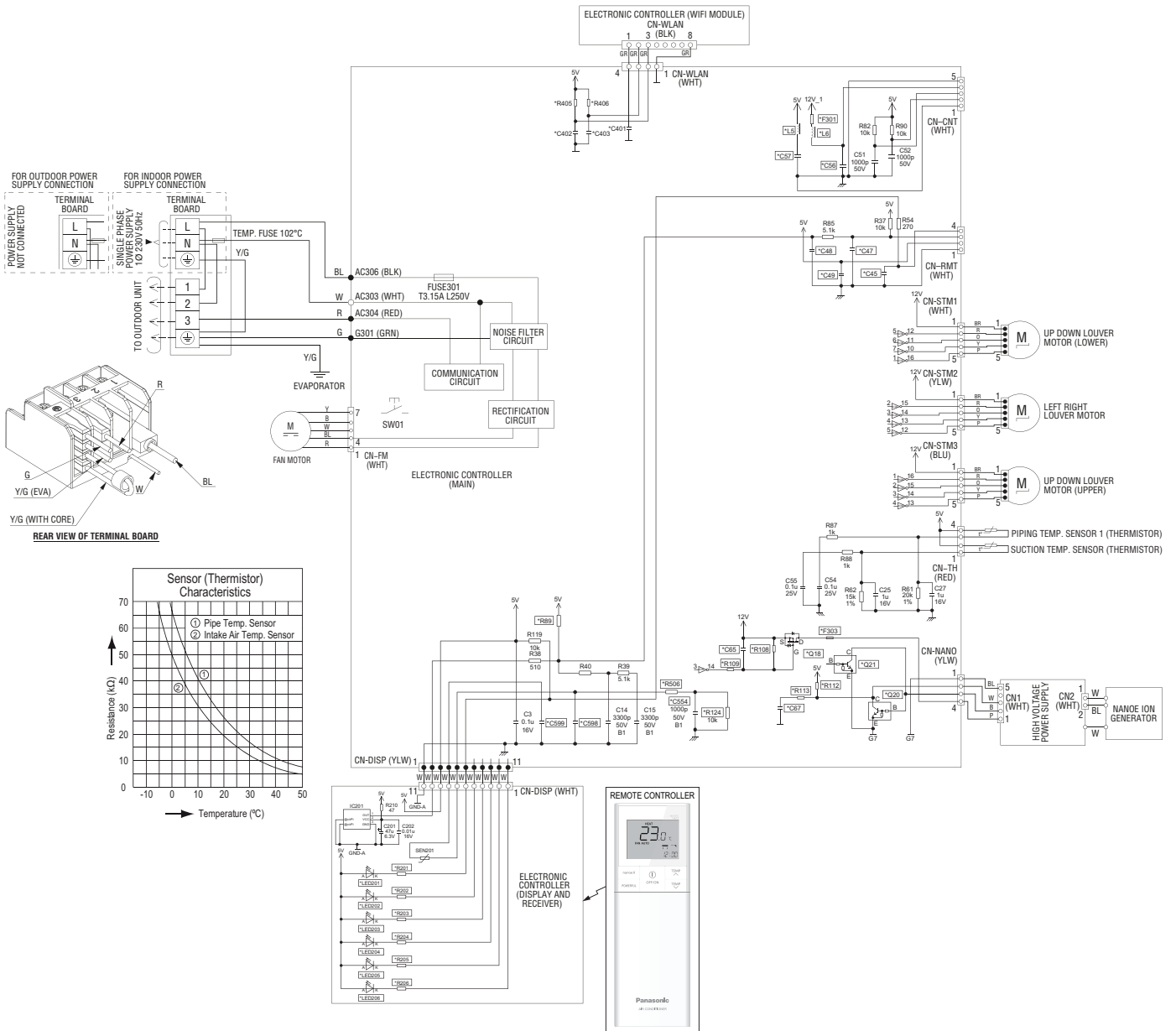

10.2 Outdoor Unit

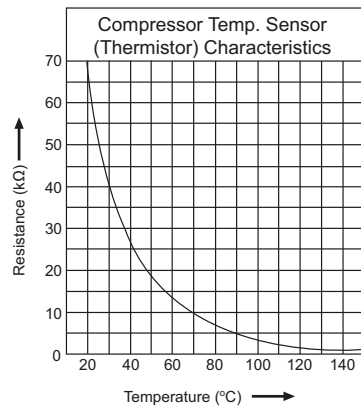
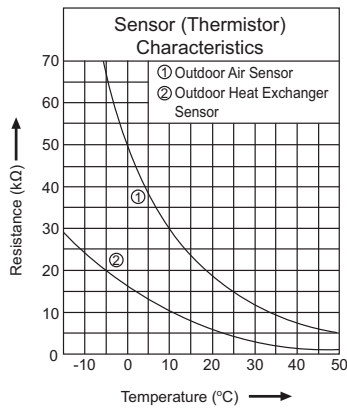
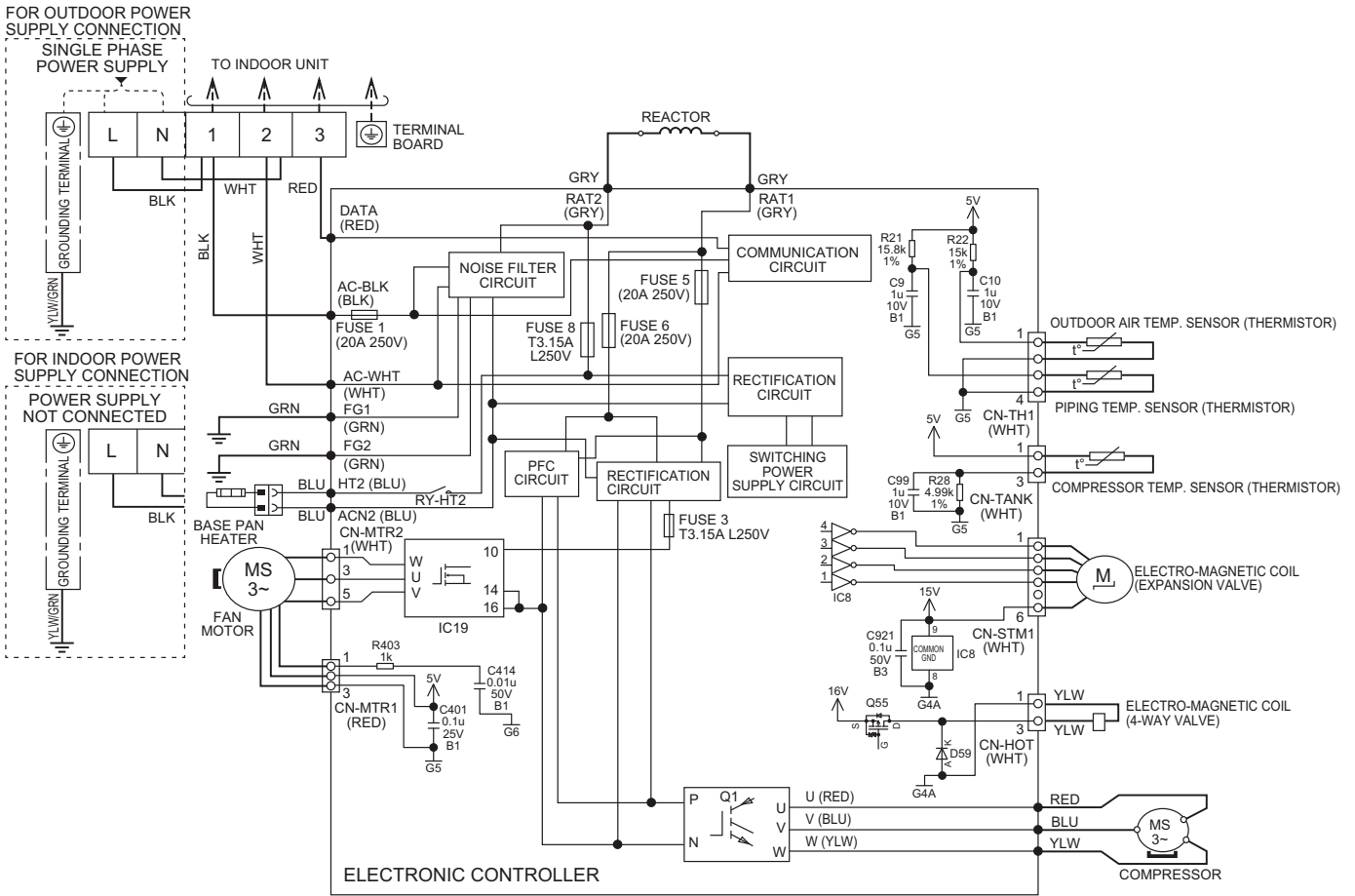

11. Printed Circuit Board

11.1 Indoor Unit

11.1.1 Main Printed Circuit Board

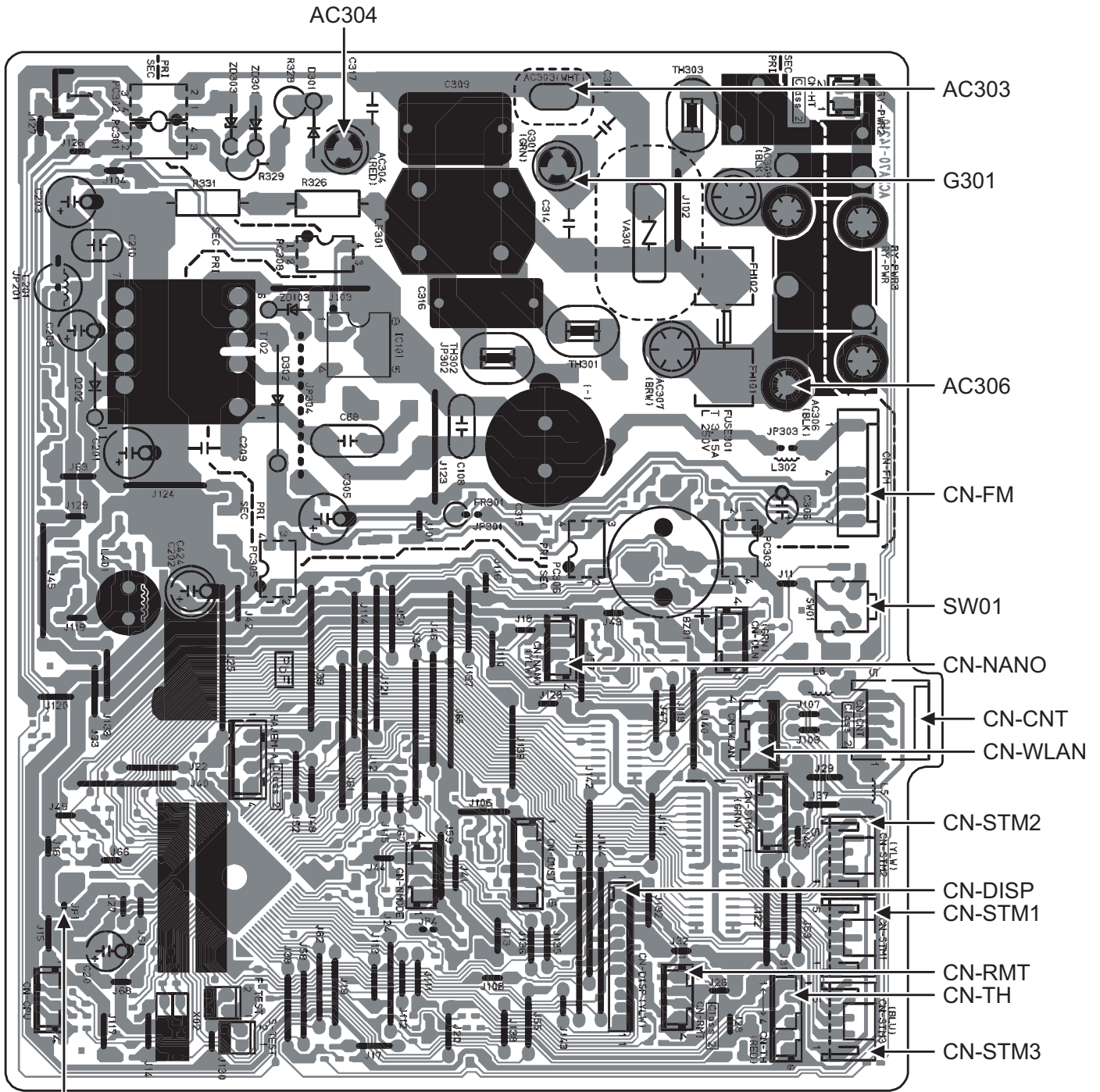

JP1 (Random Auto Restart Enable/Disable)

11.1.2 Indicator & Receiver Printed Circuit Board

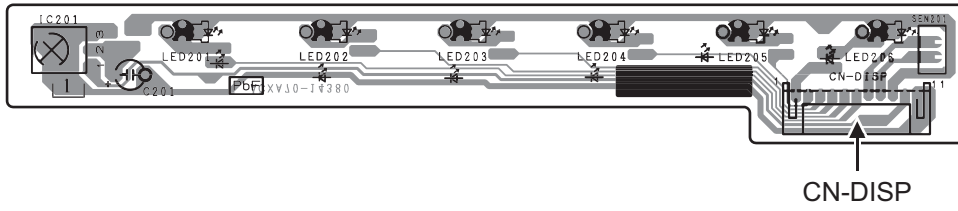

11.1.3 nanoe™X Printed Circuit Board

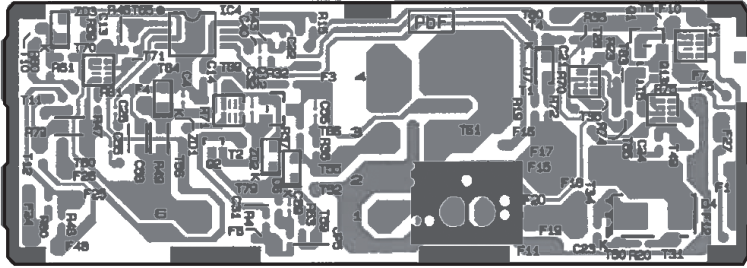

11.1.4 Wireless LAN Module Printed Circuit Board (Network Adapter)

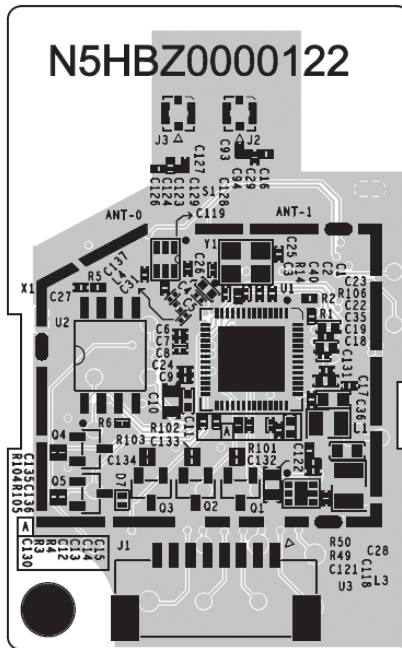

11.2 Outdoor Unit

11.2.1 Main Printed Circuit Board

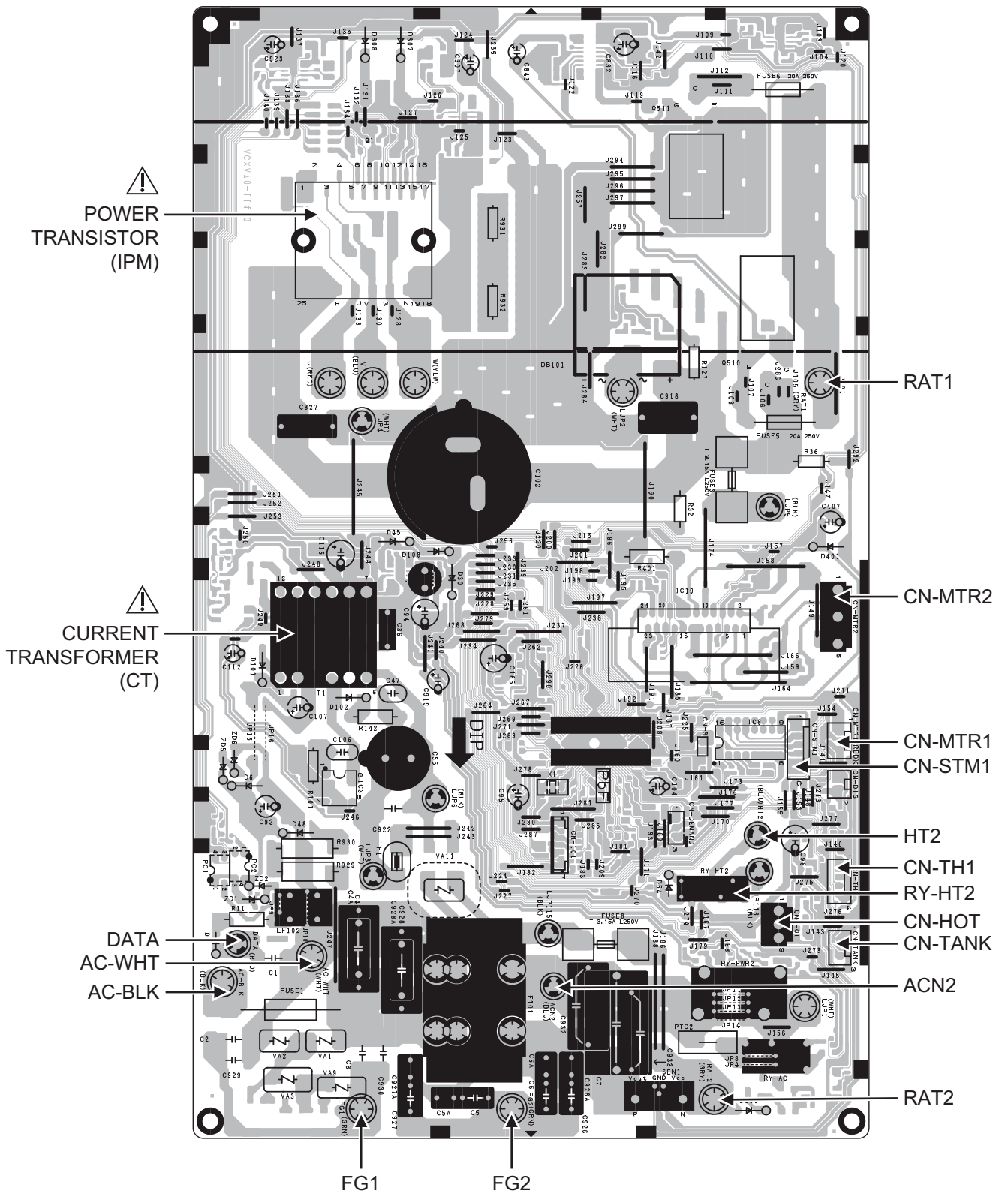

12. Installation Instruction

12.1 Select the Best Location

12.1.1 Indoor Unit

- Do not install the unit in excessive oil fume area such as kitchen, workshop and etc.
- There should not be any heat source or steam near the unit.
- There should not be any obstacles blocking the air circulation.
- A place where air circulation in the room is good.
- A place where drainage can be easily done.
- A place where noise prevention is taken into consideration.
- Do not install the unit near the door way.
- Ensure the spaces indicated by arrows from the wall, ceiling, fence or other obstacles.
- Recommended installation height for indoor unit is at 1.8 m or more from the floor.

12.1.2 Outdoor Unit

- If an awning is built over the unit to prevent direct sunlight or rain, be careful that heat radiation from the condenser is not obstructed.
- There should not be any animal or plant which could be affected by hot air discharged.
- Keep the spaces indicated by arrows from wall, ceiling, fence or other obstacles.
- Do not place any obstacles which may cause a short circuit of the discharged air.
- If piping length is over the [piping length for additional gas], additional refrigerant should be added as shown in the table.

12.1.3 Indoor/Outdoor Unit Installation Diagram

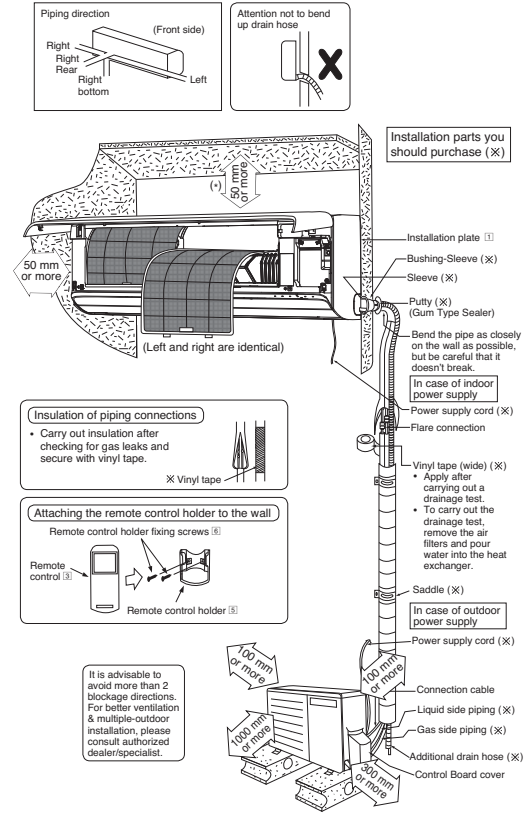

- This illustration is for explanation purposes only. The indoor unit will actually face a different way.
- (*) If holder at the rear of chassis (Refer column "12.2.3 Indoor Unit Installation") need to be used to prop up the unit, this distance shall be 65 mm or more.

Table A

Model	Capacity W (HP)	Piping size		Std. Length (m)	Max Elevation (m)	Min. Piping Length (m)	Max. Piping Length (m)	Additional Refrigerant (g/m)	Piping Length for add. gas (m)	Max. Refrigerant Charge (kg)	Indoor A _{min} (m ²)
		Gas	Liquid								
HZ25***	1.0HP	9.52 mm (3/8")	6.35 mm (1/4")	5	10	3	20	10	7.5	1.19	Not applicable (*)
HZ35***	1.5HP				10	3	20	10	7.5	1.19	Not applicable (*)

(*) Systems with total refrigerant charge, m_c , lower than 1.84kg are not subjected to any room area requirements.

Example: For HZ25***

If the unit is installed at 10 m distance, the quantity of additional refrigerant should be 25 g ... (10-7.5) m x 10 g/m = 25g.

$$A_{min} = (m_c / (2.5 \times (LFL)^{(5/4)} \times h_0))^2 \quad \text{** not less than safety factor margin}$$

- A_{min} = Required minimum room area, in m²
- m_c = Refrigerant charge in appliance, in kg
- LFL = Lower flammability limit (0.307 kg/m³)
- h_0 = Installation height of the appliance (1.8 m for wall mounted)
- SF = Safety factor with a value of 0.75

** The required minimum room area, A_{min} , shall also be governed by the safety factor margin formula below :

$$A_{min} = m_c / (SF \times LFL \times h_0)$$

The higher value shall be taken when determining the room area.

12.2 Indoor Unit

12.2.1 How to Fix Installation Plate

The mounting wall shall be strong and solid enough to prevent it from the vibration.

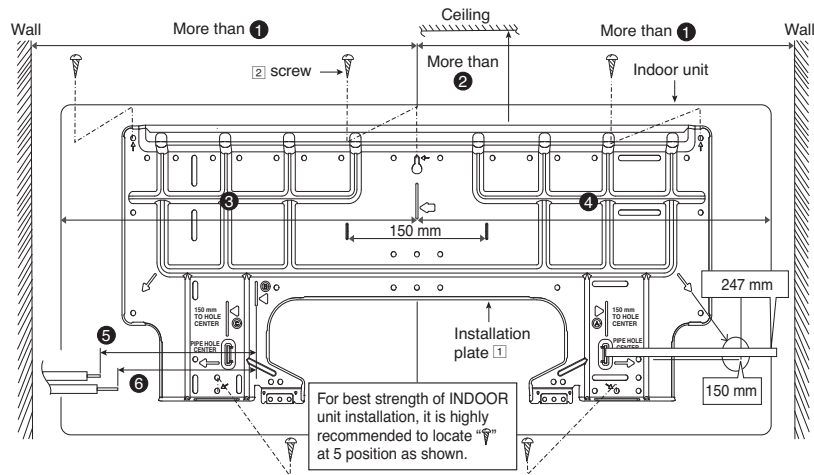

Model	Dimension					
	1	2	3	4	5	6
HZ25***, HZ35***	500 mm	70 mm (*)	420 mm	450 mm	117 mm	65 mm

- The center of installation plate should be at more than ① at right and left of the wall.
 - The distance from installation plate edge to ceiling should more than ②.
 - From installation plate center to unit's left side is ③.
 - From installation plate center to unit's right side is ④.
- Ⓑ
- For left side piping, piping connection for liquid should be about ⑤ from this line.
 - For left side piping, piping connection for gas should be about ⑥ from this line.

Dimension ②
(*) :- If holder at the rear of chassis (Refer column "12.2.3 Indoor Unit Installation") need to be used to prop up the unit, this distance shall be 85 mm or more.

- 1 Mount the installation plate on the wall with 5 screws or more (at least 5 screws). (If mounting the unit on the concrete wall, consider using anchor bolts.)
 - Always mount the installation plate horizontally by aligning the marking-off line with the thread and using a level gauge.
- 2 Drill the piping plate hole with $\varnothing 70$ mm hole-core drill.
 - Line according to the left and right side of the installation plate. The meeting point of the extended line is the center of the hole.
Another method is by putting measuring tape at position as shown in the diagram above. The hole center is obtained by measuring the distance namely 150 mm for left and right hole respectively.
 - Drill the piping hole at either the right or the left and the hole should be slightly slanting to the outdoor side.

12.2.2 To Drill a Hole in the Wall and Install a Sleeve of Piping

- 1 Insert the piping sleeve to the hole.
- 2 Fix the bushing to the sleeve.
- 3 Cut the sleeve until it extrudes about 15 mm from the wall.

⚠ CAUTION

- ❗ When the wall is hollow, please be sure to use the sleeve for tube assembly to prevent dangers caused by mice biting the connection cable.

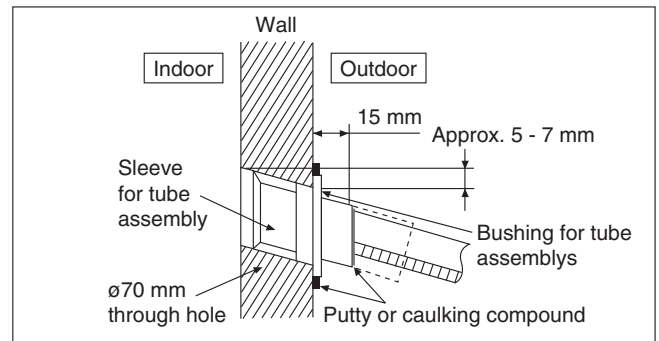

- 4 Finish by sealing the sleeve with putty or caulking compound at the final stage.

12.2.3 Indoor Unit Installation

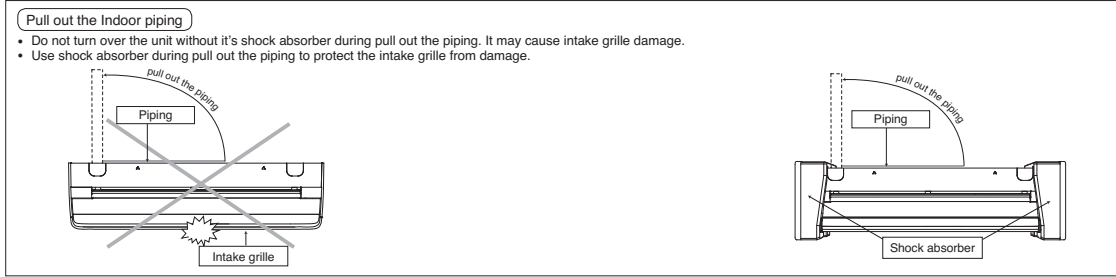

12.2.3.1 For the Right Rear Piping

- Step-1** Pull out the Indoor piping
- Step-2** Install the Indoor Unit
- Step-3** Secure the Indoor Unit
- Step-4** Insert the connection cable

12.2.3.2 For the Right and Right Bottom Piping

- Step-1** Pull out the Indoor piping
- Step-2** Install the Indoor Unit
- Step-3** Insert the connection cable
- Step-4** Secure the Indoor Unit

12.2.3.3 For the Embedded Piping

- Step-1** Change the drain hose position
- Step-2** Bend the embedded piping
 - Use a spring bender or equivalent to bend the piping so that the piping is not crushed.
- Step-3** Pull the connection cable into Indoor Unit
 - The indoor unit and outdoor unit connection cable can be connected without removing the front grille.
- Step-4** Cut and flare the embedded piping
 - When determining the dimensions of the piping, slide the unit all the way to the left on the installation plate.
 - Refer to the column "Cutting and flaring the piping".
- Step-5** Install the Indoor Unit
- Step-6** Connect the piping
 - Please refer to "Connecting the piping" column in outdoor unit section. (Below steps are done after connecting the outdoor piping and gas-leakage confirmation).
- Step-7** Insulate and finish the piping
 - Please refer to "Insulation of piping connection" column as mentioned in indoor/outdoor unit installation.
- Step-8** Secure the Indoor Unit

- Fasten the chassis to the installation plate with screws (Self purchase, Screw size: M4, max. length 10mm) to provide a neat appearance of indoor unit.

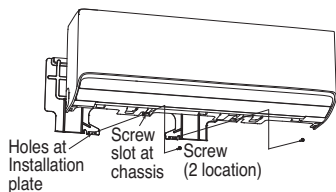

Right Rear piping

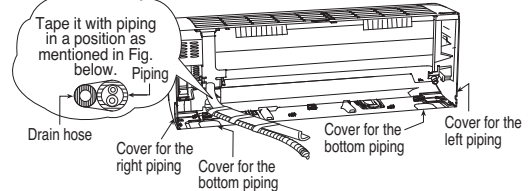

How to keep the cover

In case of the cover is cut, keep the cover at the rear of chassis as shown in the illustration for future reinstallation.

(Left, right and 2 bottom covers for piping.)

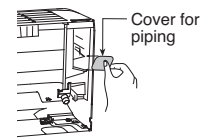

Right and Right bottom piping

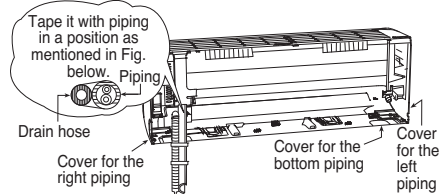

Install the indoor unit

Hook the indoor unit onto the upper portion of installation plate. (Engage the indoor unit with the upper edge of the installation plate). Ensure the hooks are properly seated on the installation plate by moving it in left and right.

There is an option to use the holder at the rear of chassis to prop up the indoor unit as shown in the illustration for ease of installation. Push the holder back to original position before secure the indoor unit.

Alternatively, bottom plate of the indoor unit can be removed to enlarge the space for installation. Please refer column "How to take out front grille".

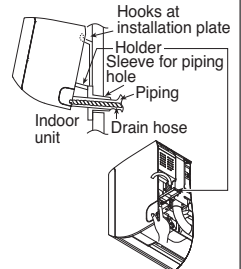

- Press the area of orange color to release holder.

Secure the Indoor Unit

Press the lower left and right side of the unit against the installation plate until hooks engages with their slot (sound click).

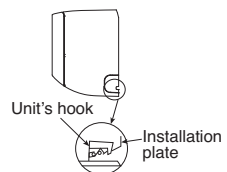

Insert the connection cable

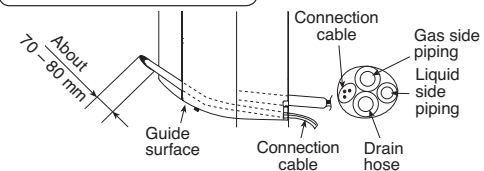

To take out the unit, push the ∇ marking at the bottom unit, and pull it slightly towards you to disengage the hooks from the unit.

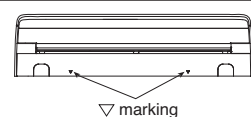

(This can be used for left rear piping also.)

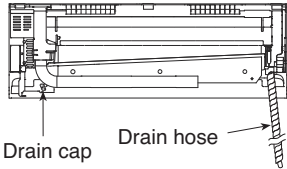
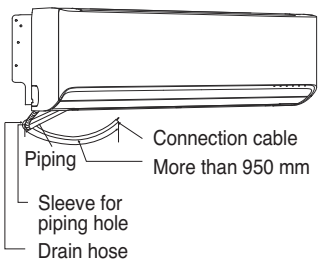
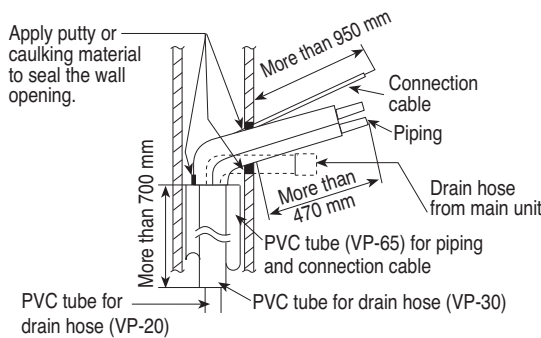
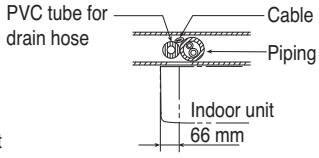
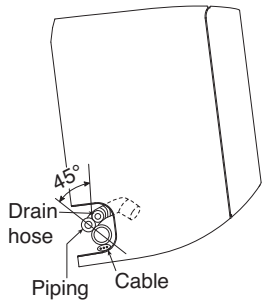
<p>Change the drain hose position</p> <p>Rear view for left piping installation</p>  <p>Drain cap Drain hose</p>	 <p>Connection cable More than 950 mm</p> <p>Piping</p> <p>Sleeve for piping hole</p> <p>Drain hose</p>
<ul style="list-style-type: none"> How to pull the piping and drain hose out, in case of the embedded piping.  <p>Apply putty or caulking material to seal the wall opening.</p> <p>More than 950 mm</p> <p>Connection cable</p> <p>Piping</p> <p>Drain hose from main unit</p> <p>More than 470 mm</p> <p>PVC tube (VP-65) for piping and connection cable</p> <p>More than 700 mm</p> <p>PVC tube for drain hose (VP-20)</p> <p>PVC tube for drain hose (VP-30)</p>  <p>PVC tube for drain hose</p> <p>Cable</p> <p>Piping</p> <p>Indoor unit 66 mm</p>	<ul style="list-style-type: none"> In case of left piping how to insert the connection cable and drain hose.  <p>45°</p> <p>Drain hose</p> <p>Piping</p> <p>Cable</p> <p>(For the right piping, follow the same procedure)</p>

12.2.4 Connect the Cable to the Indoor Unit

- The inside and outside connection cable can be connected without removing the front grille.
- Decide on the type of power supply connection to be used, indoor power supply or outdoor power supply.

In case of indoor power supply

- Install the indoor unit on the installing holder that mounted on the wall.
- Open the front panel and grille door by loosening the screw.
- Cable connection to the power supply through Isolating Devices (Disconnecting means).
 - Connect approved type polychloroprene sheathed **power supply cord** 3 x 1.5 mm² type designation 60245 IEC 57 or heavier cord to the terminal board, and connect the others end of the cord to Isolating Devices (Disconnecting means).
 - Do not use joint power supply cord. Replace the wire if the existing wire (from concealed wiring, or otherwise) is too short.
 - In unavoidable case, joining of power supply cord between isolating devices and terminal board of air conditioner shall be done by using approved socket and plug with earth pin rated 15/16 A. Wiring work to both socket and plug must follow to national wiring standard.
- Bind all the power supply cord lead wire with tape and route the power supply cord via the left escapement.
- Connection cable** between indoor unit and outdoor unit shall be approved polychloroprene sheathed 4 x 1.5 mm² flexible cord, type designation 60245 IEC 57 or heavier cord. Do not use joint connection cable. Replace the wire if the existing wire (from concealed wiring, or otherwise) is too short. Allowable connection cable length of each indoor unit shall be 30 m or less.
- Bind all the indoor and outdoor connection cable with tape and route the connection cable via the right escapement.

- 9 Remove the tapes and connect the power supply cord and connection cable between indoor unit and outdoor unit according to the diagram below.

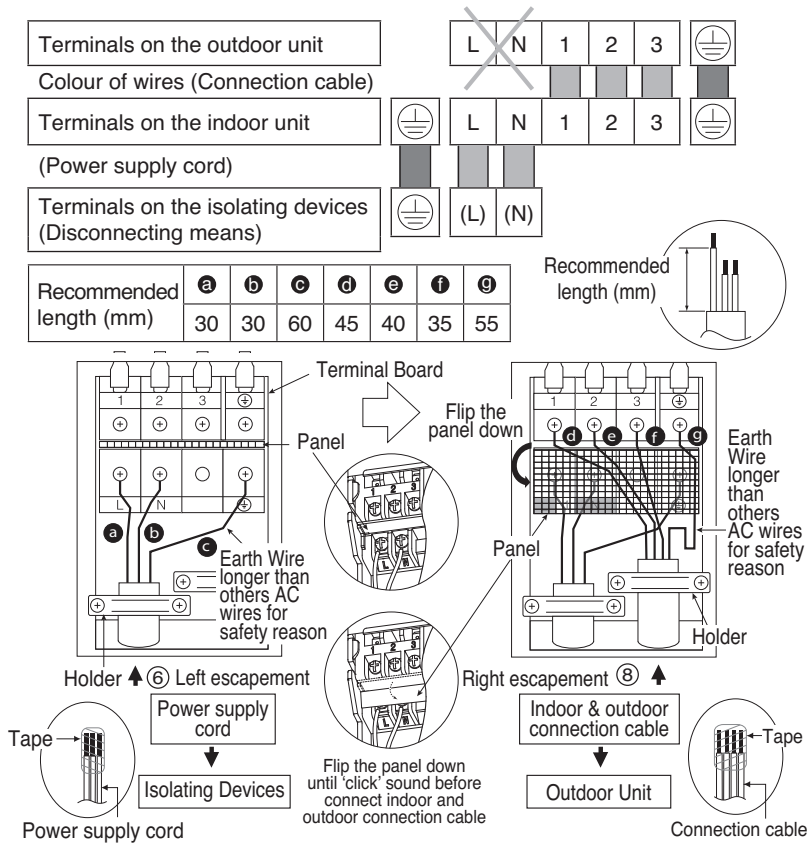

- 10 Secure the power supply cord and connection cable onto the control board with the holder.

- 11 Close grille door by tighten with screw and close the front panel.

In case of outdoor power supply

- 3 Connection cable** between indoor unit and outdoor unit shall be approved polychloroprene sheathed $4 \times 1.5 \text{ mm}^2$ flexible cord, type designation 60245 IEC 57 or heavier cord. Do not use joint connection cable. Replace the wire if the existing wire (from concealed wiring, or otherwise) is too short. Allowable connection cable length of each indoor unit shall be 30 m or less.
- 4** Bind all the indoor and outdoor connection cable with tape and route the connection cable via the left escapement.
- 5** Remove the tapes and connect the connection cable between indoor unit and outdoor unit according to the diagram below.

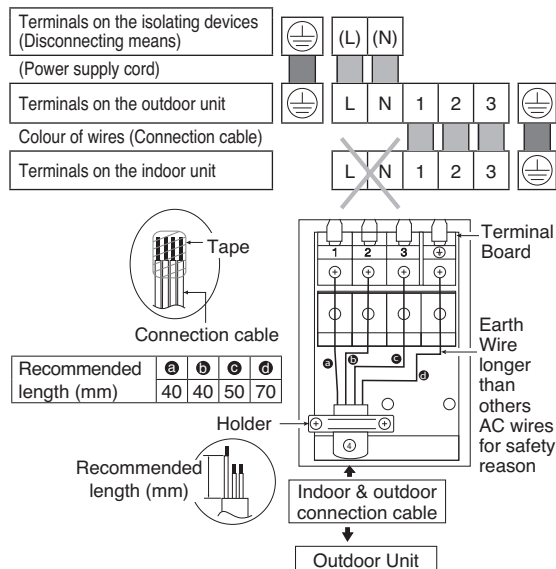

6 Secure the connection cable onto the control board with the holder.

⚠ WARNING
⚡ This equipment must be properly earthed.

- Ensure the colour of wires of outdoor unit and the terminal Nos. are the same to the indoor's respectively.
- Earth wire shall be Yellow/Green (Y/G) in colour and longer than other AC wires for safety reason.

12.2.4.1 Wire Stripping and Connecting Requirement

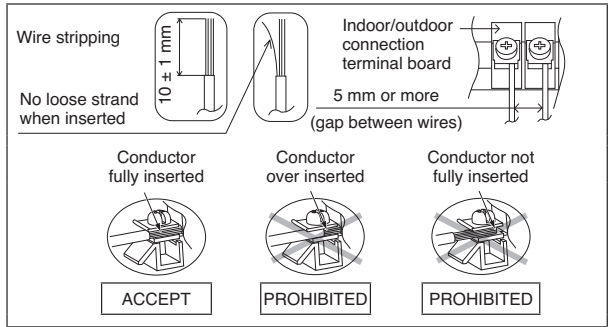

⚠ WARNING RISK OF FIRE JOINING OF WIRES MAY CAUSE OVERHEATING AND FIRE.	In case of indoor power supply	In case of outdoor power supply
	<ul style="list-style-type: none"> ❗ Use complete wire without joining. ❗ Use approved socket and plug with earth pin. ❗ Wire connection in this area must follow to national wiring rules. <p style="text-align: center;">⊘ Do not joint wires</p> <p style="text-align: center;"> ⚠ CAUTION Do not connect power supply to indoor and outdoor unit at the same time. Risk of fire if wrong connection of power supply. </p>	

12.2.4.2 Cutting and Flaring the Piping

- 1 Please cut using pipe cutter and then remove the burrs.
- 2 Remove the burrs by using reamer. If burrs is not removed, gas leakage may be caused. Turn the piping end down to avoid the metal powder entering the pipe.
- 3 Please make flare after inserting the flare nut onto the copper pipes.

12.3 Outdoor Unit

12.3.1 Install the Outdoor Unit

- After selecting the best location, start installation to Indoor/Outdoor Unit Installation Diagram.
 - Fix the unit on concrete or rigid frame firmly and horizontally by bolt nut ($\varnothing 10$ mm).
 - When installing at roof, please consider strong wind and earthquake. Please fasten the installation stand firmly with bolt or nails.

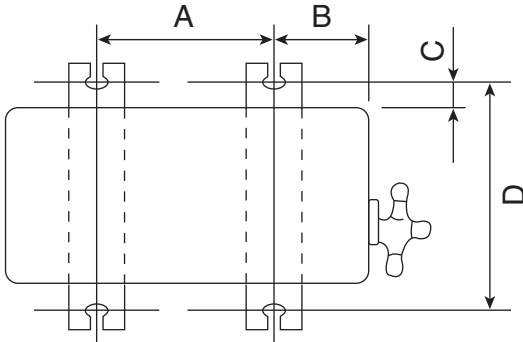

Model	A	B	C	D
HZ25***, HZ35***	540 mm	160 mm	18.5 mm	330 mm

12.3.2 Connect the Piping

12.3.2.1 Connecting the Piping to Indoor

For connection joint of all models

Please make flare after inserting flare nut (locate at joint portion of tube assembly) onto the copper pipe. (In case of using long piping)

Connect the piping

- Align the center of piping and sufficiently tighten the flare nut with fingers.
- Further tighten the flare nut with torque wrench in specified torque as stated in the table.

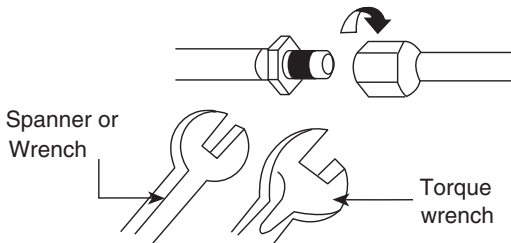

Additional Precautions For R32 Models when connecting by flaring at indoor side



Ensure to do the re-flaring of pipes before connecting to units to avoid leaking.

Seal sufficiently the flare nut (both gas and liquid sides) with neutral cure (Alkoxy type) & ammonia-free silicone sealant and insulation material to avoid the gas leak caused by freezing.

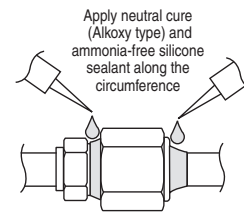

Neutral cure (Alkoxy type) & ammonia-free silicone sealant is only to be applied after pressure testing and cleaning up by following instructions of sealant, only to the outside of the connection. The aim is to prevent moisture from entering the connection joint and possible occurrence of freezing. Curing sealant will take some time. Make sure sealant will not peel off when wrapping the insulation.

12.3.2.2 Connecting the Piping to Outdoor

Decide piping length and then cut by using pipe cutter. Remove burrs from cut edge.

Make flare after inserting the flare nut (locate at valve) onto the copper pipe. Align center of piping to valve and then tighten with torque wrench to the specified torque as stated in the table.



Do not overtighten, overtightening may cause gas leakage.

Piping size	Torque
6.35 mm (1/4")	[18 N•m (1.8 kgf•m)]
9.52 mm (3/8")	[42 N•m (4.3 kgf•m)]
12.7 mm (1/2")	[55 N•m (5.6 kgf•m)]
15.88 mm (5/8")	[65 N•m (6.6 kgf•m)]
19.05 mm (3/4")	[100 N•m (10.2 kgf•m)]

12.3.3 Air Tightness Test on the Refrigerating System

Do not purge the air with refrigerants but use a vacuum pump to vacuum the installation.

There is no extra refrigerant in the outdoor unit for air purging.

- Before system is charged with refrigerant and before the refrigerating system is put into operation, below site test procedure and acceptance criteria shall be verified by the certified technicians, and/or the installer.
- Be sure to check whole system for gas leakage.

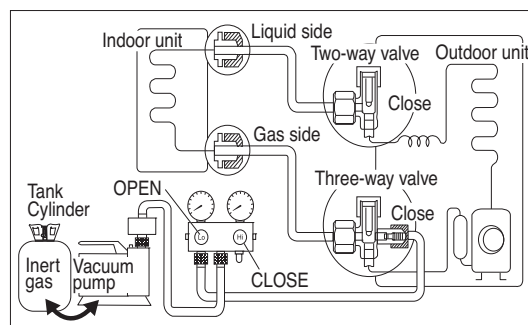
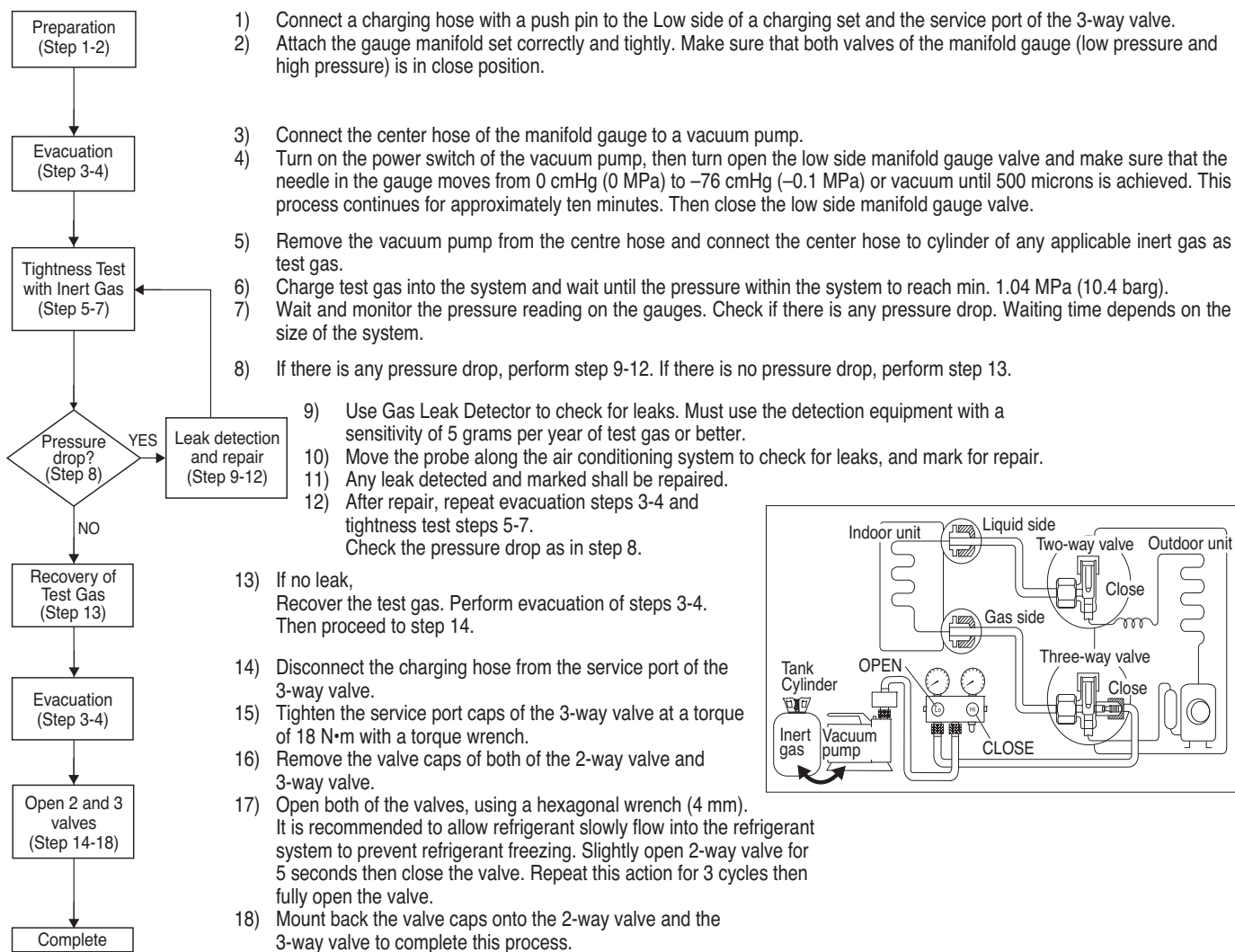

Notes:

Recommended use of any of the following leak detector,

- I) Universal Sniffer leak detector
- II) Electronic halogen leak detector
- III) Ultrasonic Leak Detector

12.3.4 Connect the Cable to the Outdoor Unit

- 1 Remove the control board cover from the unit by loosening the screw.
- 2 Connect cables to the unit.

In case of indoor power supply

- 3 **Connection cable** between indoor unit and outdoor unit shall be approved polychloroprene sheathed $4 \times 1.5 \text{ mm}^2$ flexible cord, type designation 60245 IEC 57 or heavier cord. Do not use joint connection cable. Replace the wire if the existing wire (from concealed wiring, or otherwise) is too short. Allowable connection cable length of each indoor unit shall be 30 m or less.

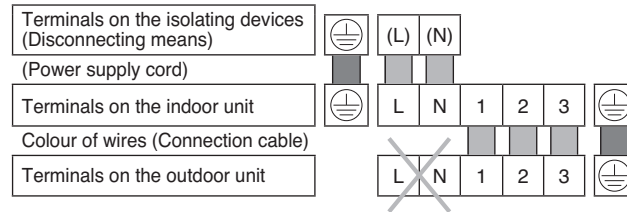

- 4 Secure the cable onto the control board with the holder (clammer).
- 5 Attach the control board cover back to the original position with screw.

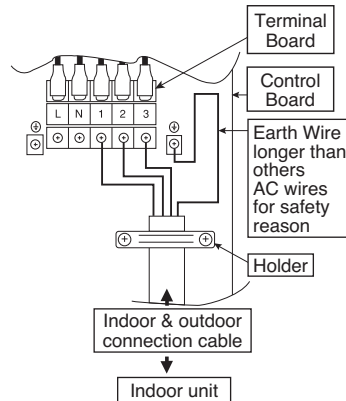

⚠ WARNING

⚡ This equipment must be properly earthed.

In case of outdoor power supply

- 3 Cable connection to the power supply through Isolating Devices (Disconnecting means).
 - Connect approved type polychloroprene sheathed **power supply cord** $3 \times 1.5 \text{ mm}^2$ type designation 60245 IEC 57 or heavier cord to the terminal board, and connect the others end of the cord to Isolating Devices (Disconnecting means).
 - Do not use joint power supply cord. Replace the wire if the existing wire (from concealed wiring, or otherwise) is too short.
 - In unavoidable case, joining of power supply cord between isolating devices and terminal board of air conditioner shall be done by using approved socket and plug with earth pin rated 15/16 A. Wiring work to both socket and plug must follow to national wiring standard.
- 4 **Connection cable** between indoor unit and outdoor unit shall be approved polychloroprene sheathed $4 \times 1.5 \text{ mm}^2$ flexible cord, type designation 60245 IEC 57 or heavier cord. Do not use joint connection cable. Replace the wire if the existing wire (from concealed wiring, or otherwise) is too short. Allowable connection cable length of each indoor unit shall be 30 m or less.

- Connect the power supply cord and connection cable between indoor unit and outdoor unit according to the diagram below.

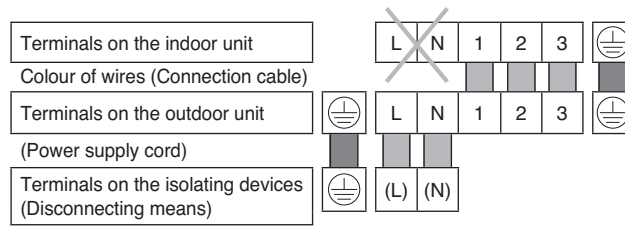

- Secure the power supply cord and connection cable onto the control board with the holder.
- Attach the control board cover back to the original position with screw.

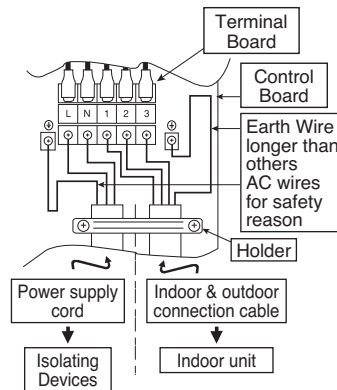

⚠ WARNING
 ⚡ This equipment must be properly earthed.

- For wire stripping and connection requirement, refer to instruction 12.2.4 of indoor unit.
- Isolating Devices (Disconnecting means) should have minimum 3.0 mm contact gap.
- Earth wire shall be Yellow/Green (Y/G) in colour and longer than other AC wires for safety reason.

12.3.5 Piping Insulation

- Please carry out insulation at pipe connection portion as mentioned in Indoor/Outdoor Unit Installation Diagram. Please wrap the insulated piping end to prevent water from going inside the piping.
- If drain hose or connecting piping is in the room (where dew may form), please increase the insulation by using POLY-E FOAM with thickness 6 mm or above.

12.3.6 How to Take Out Front Grille

- 1 Pull down 3 caps at the bottom, then remove 3 mounting screws.
- 2 Cling finger around screw area slot, pull the bottom plate downward until a click sound indicates hook is unleashed. Move the bottom plate forward carefully.
- 3 Open front panel.
- 4 Remove 3 mounting screws on the front grille.
- 5 Slide the 3 lock knobs on the upside of front grille to unlock position.
- 6 Set the upper vane to horizontal position.
Set the lower vane to slightly below horizontal position.
- 7 Pull the front grille towards you to remove the front grille.

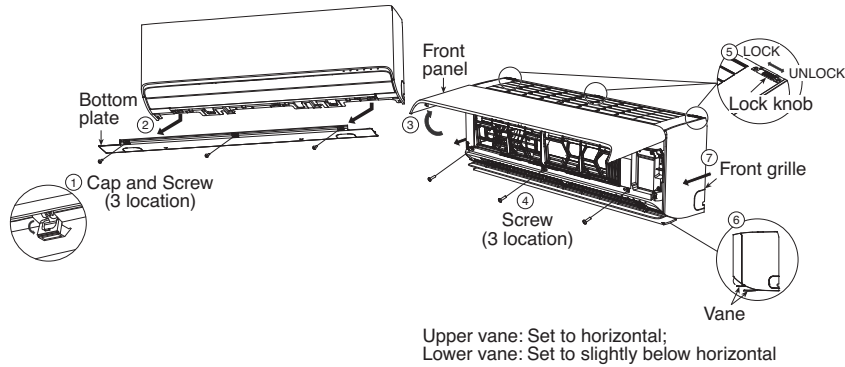

12.3.7 Auto Switch Operation

The below operations will be performed by pressing the “AUTO” switch.

- 1 **AUTO OPERATION MODE**
The Auto operation will be activated immediately once the Auto Switch is pressed and release within 5 sec..
- 2 **TEST RUN OPERATION (FOR PUMP DOWN/SERVICING PURPOSE)**
The Test Run operation will be activated if the Auto Switch is pressed continuously for more than 5 sec. to below 8 sec..
A “pep” sound will occur at the fifth sec., in order to identify the starting of Test Run operation.
- 3 **HEATING TRIAL OPERATION**
Press the “AUTO” switch continuously for more than 8 sec. to below 11 sec. and release when a “pep pep” sound is occurred at eight sec. (However, a “pep” sound is occurred at fifth sec..) then press Remote controller “A/C Reset” button once.
Remote controller signal will activate operation to force heating mode.
- 4 **REMOTE CONTROLLER RECEIVING SOUND ON/OFF**
The ON/OFF of Remote controller receiving sound can be change over by the following steps:
 - a) Press “AUTO” switch continuously for more than 16 sec. to below 21 sec..
A “pep”, “pep”, “pep”, “pep” sound will occur at the sixteenth sec..
 - b) Press the “AC Reset” button once, “pep” sound will occur indicates that Remote controller receiving sound setting mode is activated.
 - c) Press “AUTO” switch again. Everytime “AUTO” switch is pressed (within 60 sec. interval), Remote controller receiving sound status will be reversed between ON and OFF.
Long “peep” sound indicates that Remote controller receiving sound is ON.
Short “pep” sound indicates that Remote controller receiving sound is OFF.

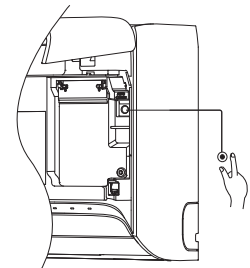

12.3.8 Heating Only Operation

- 1 Use remote controller to set heating only operation. When the unit in standby mode, follow the steps below:

- a) Press continuously for more than 5 seconds to enter special setting mode.
- b) Press to choose function 61, and then press to set “01”
- c) Press to activate “Heating only operation”

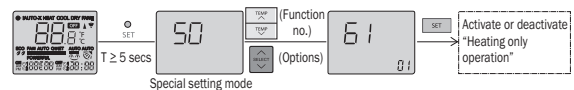

12.3.9 Check the Drainage

- Open front panel and remove air filters.
(Drainage checking can be carried out without removing the front grille.)
- Pour a glass of water into the drain tray-styrofoam.
- Ensure that water flows out from drain hose of the indoor unit.

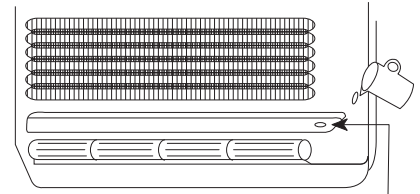

Drain tray-styrofoam

12.3.10 Outdoor Unit Drain Water

- Water will drip from the basepan hole area during defrost function.
- To avoid water dripping, do not stand or place objects at this area.

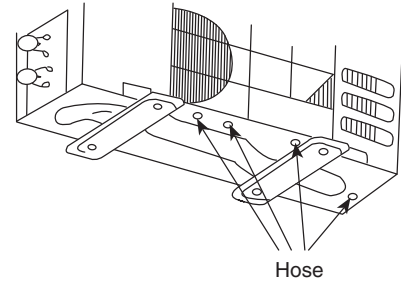

12.3.11 Evaluation of the Performance

- Operate the unit at cooling/heating operation mode for fifteen minutes or more.
- Measure the temperature of the intake and discharge air.
- Ensure the difference between the intake temperature and the discharge is more than 8°C during Cooling operation or more than 14°C during Heating operation.

Note:

- During extremely cold winter, turn on the power supply and standby the unit for at least 15 minutes before test run. Allow sufficient time to warm up refrigerant and prevent wrong error code judgement.

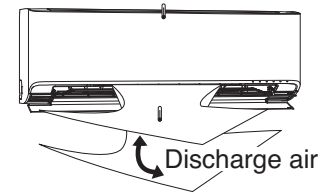

12.3.12 How to Replace Network Adapter

- Remove the front grille (refer how to take out front grille) from the unit.
- Remove the indicator piece by releasing the hook.
- Remove 1 mounting screw, then remove the network adaptor holder.
- After that, network adaptor can be easily replaced.

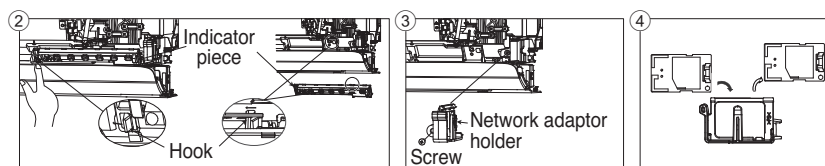

12.3.13 In Case of Reusing Existing Refrigerant Piping

- Observe the followings to decide reusing the existing refrigerant piping.
Poor refrigerant piping could result in product failure.
 - In the circumstances listed below, do not reuse any refrigerant piping. Instead, make sure to install a new piping.
 - Heat insulation is not provided for either liquid-side or gas-side piping or both.
 - The existing refrigerant pipe has been left in an open condition.
 - The diameter and thickness of the existing refrigerant piping does not meet the requirement.
 - The piping length and elevation does not meet the requirement.
 - Perform proper pump down before reuse piping.
 - In the circumstances listed below, clean it thoroughly before reuse.
 - Pump down operation cannot be performed for the existing air-conditioner.
 - The compressor has a failure history.
 - Oil color is darken. (ASTM 4.0 and above).
 - The existing air-conditioner is gas/oil heat pump type.
 - Do not reuse the flare to prevent gas leak. Make sure to install a new flare.
 - If there is a welded part on the existing refrigerant piping, conduct a gas leak check on the welded part.
 - Replace deteriorated heat insulating material with a new one.
Heat insulating material is required for both liquid-side and gas-side piping.

12.3.14 Proper Pump Down Method

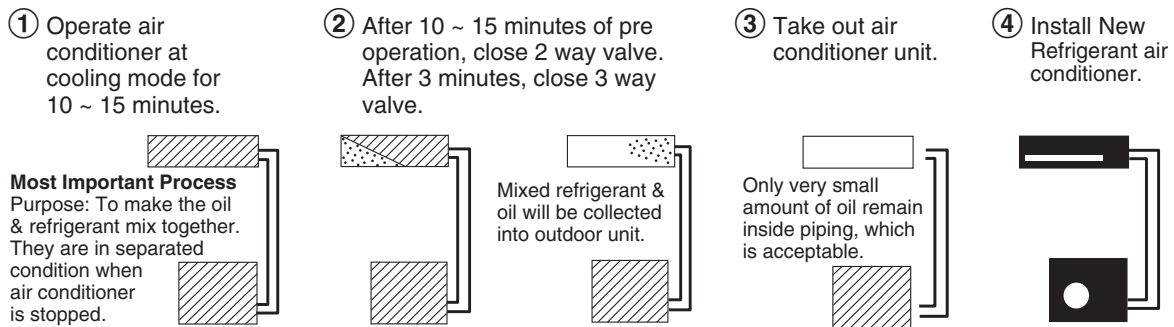

13. Installation and Servicing Air Conditioner using R32

13.1 About R32 Refrigerant

For air conditioning refrigerants such as R410A, the refrigerants were collected back in order to prevent their air dissipation, to curbe the global warming impact, in case they were released into the atmosphere. In the “4th Environmental Basic Plan”, 80% reduction of greenhouse gas emissions by 2050 is required, and due to this requirement, further reduction in the emission of high greenhouse effect gas, such as CFCs, is required. Therefore, the conversion of air conditioning refrigerant into the ones who has smaller greenhouse effect, even if it is dissipated into the atmosphere, became our responsibility.

Nevertheless, in case of air conditioning refrigerant, it would be the best if there is a refrigerant which has smaller impact on global warming, but ensures good energy efficiency and performance, and is safe; however, there is no such refrigerant which satisfies all these conditions. As a result, we have been considering the practical usage, within the safety frame-work, of R32 refrigerant which has short lifetime in the atmosphere, and has smaller effect of global warming, but is slightly flammable.

In 2004, due to the revision of air conditioner safety standards by the International Electro-safety Commission (IEC), the safety standards of air conditioners using slightly flammable refrigerant was issued. In 2010, the regulations of American Society of Heating, Refrigerating and Air-Conditioning Engineers in the United States (ANSI/ASHRAE34) was issued adopting the grades for refrigerants which are difficult to inflame due to their slow burning rates, and as a result have smaller damages in cases of fire. The burning rate of R32 is lower by 10cm / per second, and safety standardization for various usage is now being processed.

13.2 Characteristics of R32 Refrigerant

1. Chemical Characteristics

R32 is one of the refrigerants used in R410A, has almost no toxicity, and chemically stable compound formed by hydrogen, carbon and fluorine.

R32 has short lifetime of 4 to 9 years in case of being released into the atmosphere; therefore, it has smaller greenhouse gas effect but has slight inflammability because of the large proportion of hydrogen.

Chemical Characteristic Table of R32, R410A and R22.

	R32	R410A	R22
Chemical Formula	CH ₂ F ₂	CH ₂ F ₂ / CHF ₂ CF ₃	CH ₂ ClF
Composition (mixture ratio wt.%)	Single Composition	R32 / R125A (50 / 50 wt.%)	Single Composition
Boiling Point (°C)	-51.7	-51.5	-40.8
Pressure (physical) *1	3.14	3.07	1.94
Capacity (physical) *2	160	141	100
COP (physical) *3	95	91	100
Ozone Depletion Potential (ODP)	0	0	0.055
Global Warming Potential (GWP) *4	675	2090	1810
Inflammability *5	Slightly Inflammable (A2L)	Non-inflammable (A1)	Non-inflammable (A1)
Toxicity	None	None	None

*1 : Physical property of temperature condition 50°C

*2 : Relative value of temperature condition 0/50°C, providing R22=100

*3 : Te/Tc/SC/SH=5/50/3/0°C

*4 : GWP=Global Warming Potential, each figure is based on “4th IPCC4 Report”

*5 : Based on ANSI / ASHRAE std. 34-2010

2. Characteristic of Pressure

As shown in Table 2, R32 does not have much difference in vapor pressure at the same refrigerant temperature comparing to R410A, but comparing to R22, it is higher at 1.6 times more. Thus, the same as in case of R410A, it is necessary to do installation and service using high-pressure tools and components.

Table 2. Saturated vapor pressure comparison table

(Unit: MPa)

Temperature	Refrigerant		
	R32	R410A	R22
-20	0.30	0.30	0.14
0	0.71	0.70	0.40
20	1.37	1.35	0.81
40	2.38	2.32	1.43
60	3.84	3.73	2.33
65	4.29	4.17	2.60

Reference : Thermal properties table of Japan Society of Refrigerating and Air Conditioning Engineers (60, 65°C)
NIST REFPROP V8.0 (-20 ~ 40°C)

13.3 Refrigerant piping installation • Tools used in services

13.3.1 Required Tools

R32 refrigerant air conditioners use the common parts as R410A air conditioners for two-way valves and three-way valves (diameters of service ports); thus, they maintain commonality in the maintenance of the compressive strength, the size of pipe flaring, and the size of flare nuts as R410A. Therefore, for refrigerant pipe installation and services, you can use tools for R410A.

However, mixing of refrigerants is not allowed, so that you have to separate the cylinders for the recovery of refrigerants.

Tools used for installation • relocation • replacement of air conditioning units

Works	R32	R410A	R22
Flaring	Flare tools for R410A (clutch type)		Flare tools for R22 (clutch type)
Connection of pipes	Torque wrench (diameter 1/4 3/8)		
	Torque wrench (diameter 1/2 5/8) *1		Toque wrench (diameter 1/2 5/8)
Manifold gauge charging hose	R32 & R410A Common (As at November 2013)		R22 Only
Air purging	Vacuum pump + Reducer / expander		Vacuum pump
Gas leakage test	Detection liquid or soup water, HFC detector		

*1. Nut diameters of 1/2 5/8, the size of torque wrench common with R410A

For other installation, you can use general tools such as screw drivers (+, -), metal saws, electric drills, long-nose pliers, hole core drills (ø70 or ø65), linen tape, levels, temperature gauges, clamp meters, electric knives, nippers, pipe cutters, reamers or scrapers, spring benders, (diameters 1/4 3/8 1/2 5/8), monkey wrenches, fixing wrenches (17 or 12 mm), feeler gauges, hexagon wrenches (4 mm), testers, megohm testers, etc.

Tools used for services

Works	R32	R410A	R22
Insertion of refrigerant	Digital scale for refrigerant charging, refrigerant cylinders, cylinder adopters and packing *a		
Recovery of refrigerant	Refrigerant recovery devices, refrigerant cylinders, manifold gauges, charging hoses *b		

*a. Use cylinder for each refrigerant, cylinder adopter and packing.

*b. Use refrigerant recovery cylinder separately for each refrigerant (**no mixture of refrigerant allowed**). Please be aware that there are some refrigerant collection devices which do not have self-certification.

13.3.2 Tools for R32 (common with R410A)

1. Flare gauges

Use flare gauges when you perform flaring with flare tools (clutch type). Flare gauges are used to set the pipe ends at 0.5 ~ 1.5 mm from clump bars of flare tools.

Flare gauges



2. Flare tools (clutch type)

Flare tools have larger holes of clump bars in order to set the pipe end at 0 ~ 0.5 mm, and have stronger springs inside to ensure solid flaring torques. These flare tools can be used commonly for R22.

Flare tools (clutch type)



3. Torque wrenches (diameters 1/2, 5/8)

In order to strengthen the compressive strength, the diameters of wrenches change depending on the flare nut sizes.

Torque wrenches

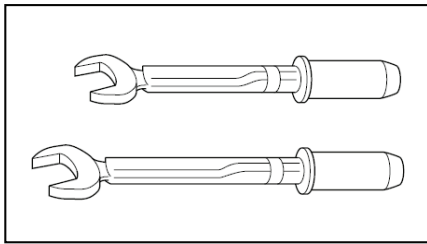

Differences in torque wrenches

	R32 (common R410A)	R22
1/2 (diameter × torque)	26 mm × 55 N•m (550 kgf•cm)	24 mm × 55 N•m (550 kgf•cm)
5/8 (diameter × torque)	29 mm × 65 N•m (650 kgf•cm)	27 mm × 65 N•m (650 kgf•cm)

4. Manifold gauges

R22 gauges cannot be used because of the high pressures.

Each port of manifold has different shapes in order to prevent inserting wrong refrigerant.

*However, the port shape for R410A and R32 is the same; therefore, attention need to be paid not to insert wrong refrigerant.

Differences in high/low pressure gauges

	R32 (common R410A)	R22
High pressure gauges (red)	-0.1 ~ 5.3 MPa -76 cmHg ~ 53 kgf / cm ²	-76 cmHg ~ 35 kgf / cm ²
Low pressure gauges (blue)	-0.1 ~ 3.8 MPa -76 cmHg ~ 38 kgf / cm ²	-76 cmHg ~ 17 kgf / cm ²

Difference in manifold port sizes

	R32 (common R410A)	R22
Port sizes	1/2 UNF20	7/16 UNF20

5. Charging hoses

The pressure resistance of charge hoses is increased. At the same time, the material is changed to HFC resistant, and the size of each manifold adopter is changed, as the port size of manifold gauge itself. Further, some hoses are with anti-gas pressure backflow valves placed near the adopters. (hoses with the valves recommended)

Manifold gauges / Charging hoses

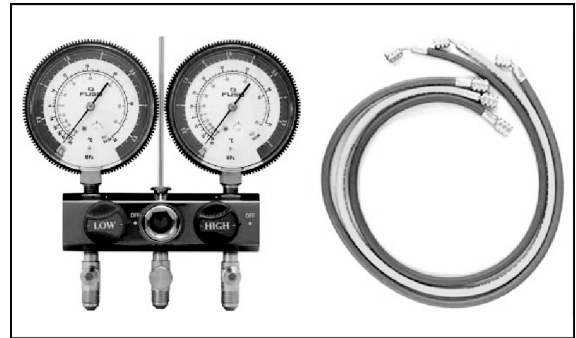

Differences in charging hoses

		R32 (common R410A)	R22
Pressure Resistance	Normal operation pressure	5.1 MPa (52 kgf / cm ²)	3.4 MPa (35 kgf / cm ²)
	Burst pressure	27.4 MPa (280 kgf / cm ²)	17.2 MPa (175 kgf / cm ²)
Material		HNBR rubber Internal nylon coating	NBR rubber

6. Vacuum pump and Vacuum pump adopter

When using a vacuum pump, it is necessary to set a solenoid valve in order to prevent backflow of vacuum pump oil into the charge hoses, and use a vacuum pump with oil backflow prevention function, or use the vacuum pump with vacuum pump adopter. If vacuum pump oil (mineral oil-based) mixes with R410A (R32), it may cause damage to the machine.

Vacuum pump

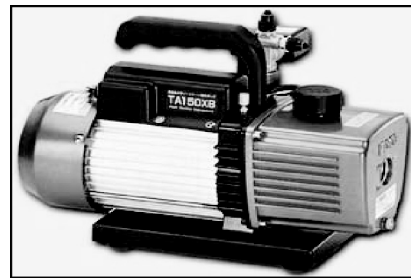

Vacuum pump adopter



7. HFC refrigerant_Electric gas leakage tester
 R32 refrigerant is often used for other mixed refrigerant (R410A, R404A, R407C etc.). Therefore, the usage of existing HFC detectors is possible, but in order to detect more accurately, we recommend to use detectors specially set and adjusted for R32 detection.

HFC refrigerant_Electric gas leakage tester



8. Digital scale for refrigerant charging
 R32 and R410A have high pressure level and their evaporation speed is high. Thus, if you recover the refrigerant by cylinder charging method, the refrigerant evaporates within the weighing scale glass, which makes reading the scale difficult, rather than liquidating the refrigerant into the cylinder. (Charging cylinders for R22 have different pressure resistance, scale, connection port size; therefore, they are not usable) At the same time, the digital scale for refrigerant charging is strengthened by receiving the weight of the refrigerant cylinders with four pillars at the corners. The connection ports of charging hoses have two separate ports for R22 (7/16 UNF20) and R32/R410A (1/2 UNF20) therefore, they can be used for the insertion of the existing refrigerants.

Digital scale for refrigerant charging



9. Refrigerant cylinders
 Refrigerant cylinders for R410A are painted in pink, and the ones for R32 are painted in other colors that might subject to change according to the international standards. R32 is a single refrigerant, so that both liquid and gas insertion are possible. Additional charging is also possible. (R410A is a mixed refrigerant, so only liquid insertion is possible)

Refrigerant cylinders



10. Connection ports of refrigerant cylinders and packing
 Charging ports which fit to the charging hose connection port size (1/2 UNF20) is needed. At the same time, the packing has to be of HFC resistant materials.

Connection ports and packing



11. Tools used for refrigerant piping installations and services

	Tools for R410A	Common with R32	Possibility of usage for R22
1.	Pipe cutters, reamers or scrapers	○	○
2.	Flare tools (clutch type)	○	○
3.	Torque wrench (1/4, 3/8)	○	○
4.	Torque wrench (1/2, 5/8)	○	×
5.	Manifold gauges · charging hoses	○	×
6.	Vacuum pumps, vacuum pump adopters	○ Connection 5/16	○ Connection 1/4
7.	Electric gas leakage testers for HFC *1	○	△
8.	Digital scale for refrigerant charging	○	○
9.	HCF recovery devices (connection port 5/16) *2	○ Connection 5/16	○ Connection 1/4
10.	Refrigerant cylinders (pressure resistant: FC3)	Same specs ×	×
11.	Refrigerant cylinders (pink)	Other (colors that might subject to change according to the international standards).	×
12.	Refrigerant cylinder connection ports and packing	○	×
13.	Allen wrench (4 mm) Electric knives	○	○
*1	Those testers only for HCFC22 (R22), but not for HCF32 (R32) and HCF410A (R410A) cannot be for common use.		
*2	Recovery devices which are self-certified for each HCF type can be used.		
	<p>[Knowledge for the common usage of tools for R410A & R32]</p> <ul style="list-style-type: none"> • R410A and R32 machines use different compressor oils. • If unregulated compressor oil gets mixed into, it may cause damage to the machine function. • Careful pump down will ensure the recovery of compressor oil, and it will minimize the remaining amount of the oil in the manifold gauge and charging hose. • If you only perform the recovery of refrigerant and not be able to perform pump down, <u>you have to dispose the compressor oil in the charging hose.</u> 		
	<p>[Precaution of repairing refrigerant cycle]</p> <ul style="list-style-type: none"> • In the brazing, open 2-way and 3way valves, and make sure the refrigerant is completely recovered back and not remaining the system. • When repairing outside, make sure no refrigerant is in the air, ensure good air flow, and perform the brazing. 		
	<p>[Inserting wrong refrigerant]</p> <ul style="list-style-type: none"> • It may cause “not cooling” and “not heating” customer claims because each component (expansion valve, compressor, PCB) of the refrigeration cycle is specially adjusted for R32. • At the same time, it is not subject to product warranty, if wrong refrigerant was inserted into the system. 		

13.4 New installation, Relocation, Repairing of Refrigerant Cycle System The Procedures

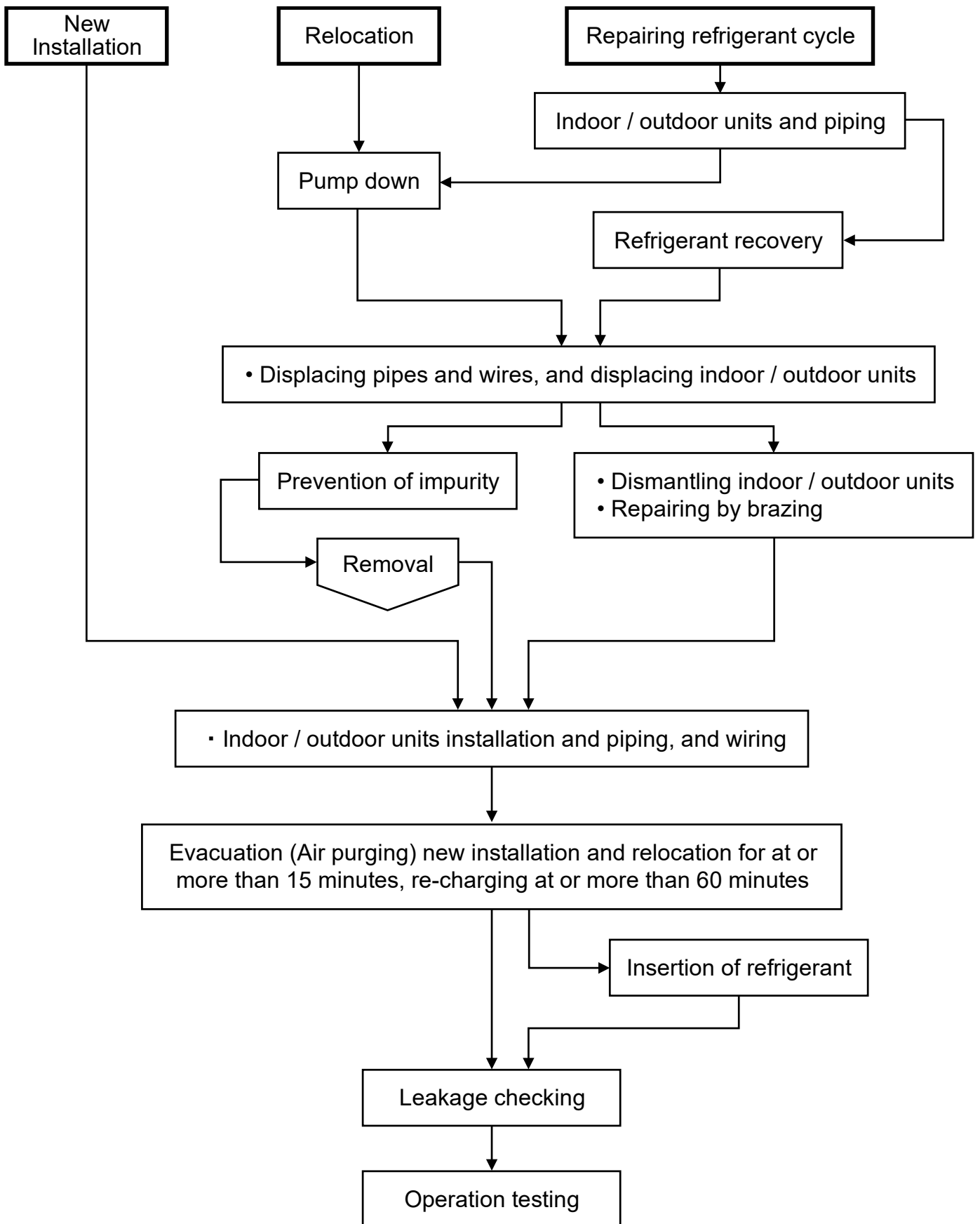

13.5 Piping installation of R32

13.5.1 Pipe materials used and flaring

Copper pipes are used for refrigerant piping. Pipes which comply with JIS Regulations need to be used. Room air conditioners which use R410A and R32 have higher pressure; thus, using pipes which comply with the Regulations is important.

The pipe thickness is regulated by revised JIS B 8607 "Flaring and brazing fittings for refrigerant" and the pipe thickness for R410A, R32 is shown in the table.

Pipe thickness

O and OL materials		Thickness (mm)		
Diameter	Diameter (mm)	R410A	R32	R22
1/4	6.35	0.80		
3/8	9.52	0.80		
1/2	12.70	0.80		
5/8	15.88	1.00		

Caution

- For connection piping, use copper phosphate seamless pipes (1220T) as regulated in "JIS H 3300" and the pipe thickness is 0.8 mm.
- In the market, there are some pipes of 0.7 mm thickness, but do not use these pipes (0.8 mm thickness has to be strictly followed).
- It is recommended to use pipes whose adhesion amount of oil is at or less than 40 mg / 10 m. At the same time, do not use pipes with dent, de-shape, and color change (especially inside).

13.5.2 Processing and connection of pipes

For refrigerant pipe installation, be aware of moisture and dirt do not get into the pipes, and make sure of no refrigerant leakage.

◎ The procedure of flaring and precautions

- Cutting of pipes : use pipe cutter and cut the pipe slowly not to de-shape the pipe.
- Removal of burrs on the edge of pipe (reamer or scraper)
If the condition of pipe edge after the deburring is no good or if burrs attaches on the flaring, it may cause refrigerant leakage. Turn the pipe end down and perform deburring carefully.
- Insert the flare nut (use the nut which is a part of the CZ parts)
- Flaring

Ensure the cleanliness of clump bar and pipe, and perform flaring carefully.

Use the existing flare tools or flare tools for R410A. Be aware that the sizes and dimensions of flaring is different in each flaring tool. If you use the existing flaring tools, use flaring gauge to measure the length of the flaring part.

Piping size (mm)	Dimensions "a" (mm) R22			Dimensions "a" (mm) R410A/R32		
	Flare tools		Flare tools for R410A	Flare tools		Flare tools for R410A
	Clutch type	Wing nut type	Clutch type	Clutch type	Wing nut type	Clutch type
6.35 (1/4")	0.5 ~ 1.0	1.0 ~ 1.5	0 ~ 0.5	1.0 ~ 1.5	1.5 ~ 2.0	0 ~ 0.5
9.52 (3/8")	0.5 ~ 1.0	1.0 ~ 1.5	0 ~ 0.5	1.0 ~ 1.5	1.5 ~ 2.0	0 ~ 0.5
12.70 (1/2")	0.5 ~ 1.0	1.5 ~ 2.0	0 ~ 0.5	1.0 ~ 1.5	2.0 ~ 2.5	0 ~ 0.5
15.88 (5/8")	0.5 ~ 1.0	1.5 ~ 2.0	0 ~ 0.5	1.0 ~ 1.5	2.0 ~ 2.5	0 ~ 0.5

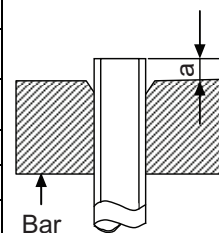

Nut outer diameter (mm)	
R22	R410A/R32
17	17
22	22
24	26
27	29

13.6 Installation, Relocation, and Service

13.6.1 Air purge and gas leak test for new installation (using new refrigerant pipes) using vacuum pump

(From the point of view of global environment protection, do not release CFCs into the atmosphere during installation work)

1. Connect the charging hose of manifold gauge to the service port of 3-way valve (pushing insect pin).
2. Fully open the handle Lo of manifold gauge and operate vacuum pump.
(If the needle of the low-pressure gauge reaches the vacuum immediately, check 1 procedure again)
3. Perform vacuuming 15 minutes or more, and make sure low pressure gauge reaches to -0.1 MPa (-76cmHg).
When the vacuuming completes, fully open the handle Lo of manifold gauge and stop the operation of vacuum pump, and leave it for 1 ~ 2 minutes. Then, remove the connection side of the charging hose of vacuum pump adaptor after checking the needle of manifold gauge does not turn back.
4. Open the stem of 2-way valve to 90° in anti-clock wise, and close the 2-way valve after 10 seconds, and perform gas leakage test.
5. Remove the charge hose from the service port of 3-way valve, and open the stems of 2-way and 3-way valves (open the valves to anti-clock wise carefully, do not use full strength to open)
6. Tighten the service port cap with torque wrench $18\text{ N}\cdot\text{m}$ ($1.8\text{ kgf}\cdot\text{m}$)
Tighten the caps of 2-way and 3-way valves with torque wrench $18\text{ N}\cdot\text{m}$ ($1.8\text{ kgf}\cdot\text{m}$)
7. After the tightening of each cap, check gas leakage around the cap.

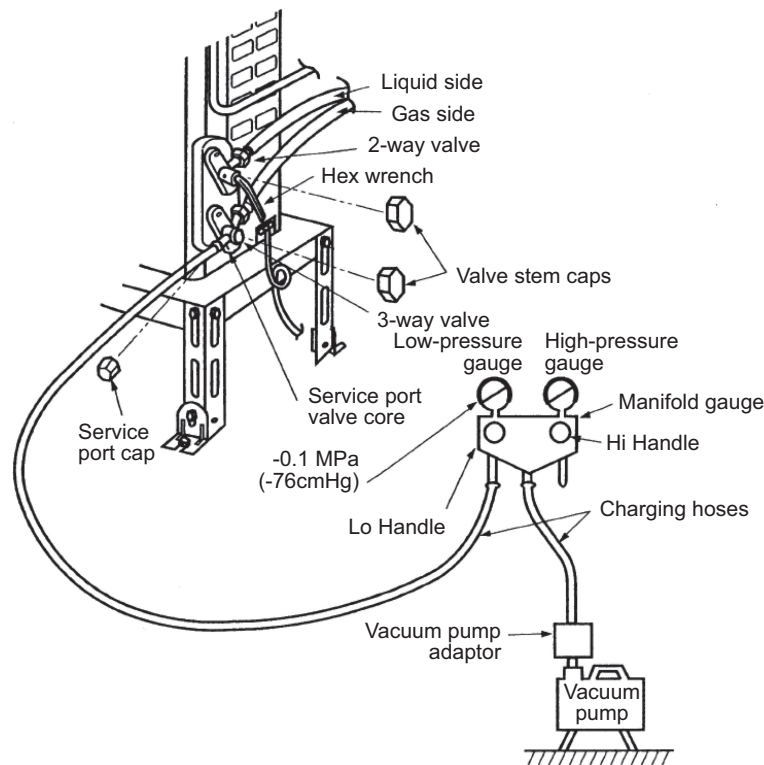

13.6.2 Process of refrigerant recovery

1. Connect the center charging hose of manifold gauge to the in-let side of recovery device.
2. Connect the valves of the discharge side of recovery device and liquid side of refrigerant cylinder with red hose (charging hose).
3. Connect the yellow float switch cable of the recovery device to the refrigerant cylinder.
4. Open the low pressure side valve of manifold gauge.
5. Insert electric plug of recovery device into electrical outlet (the fan operation starts).
6. Turn the valve 1 and 2 of recovery device to pressure equalization point.
7. After a few seconds, turn back the valve 1 and 2 to the original position.
8. Turn the switch of the recovery device to "ON". (the compressor operation starts)
9. When the low pressure of manifold gauge is close to "0", close the low pressure side valve, turn "OFF" the recovery device switch.
10. Remove the center charging hose of manifold gauge from the recovery device.

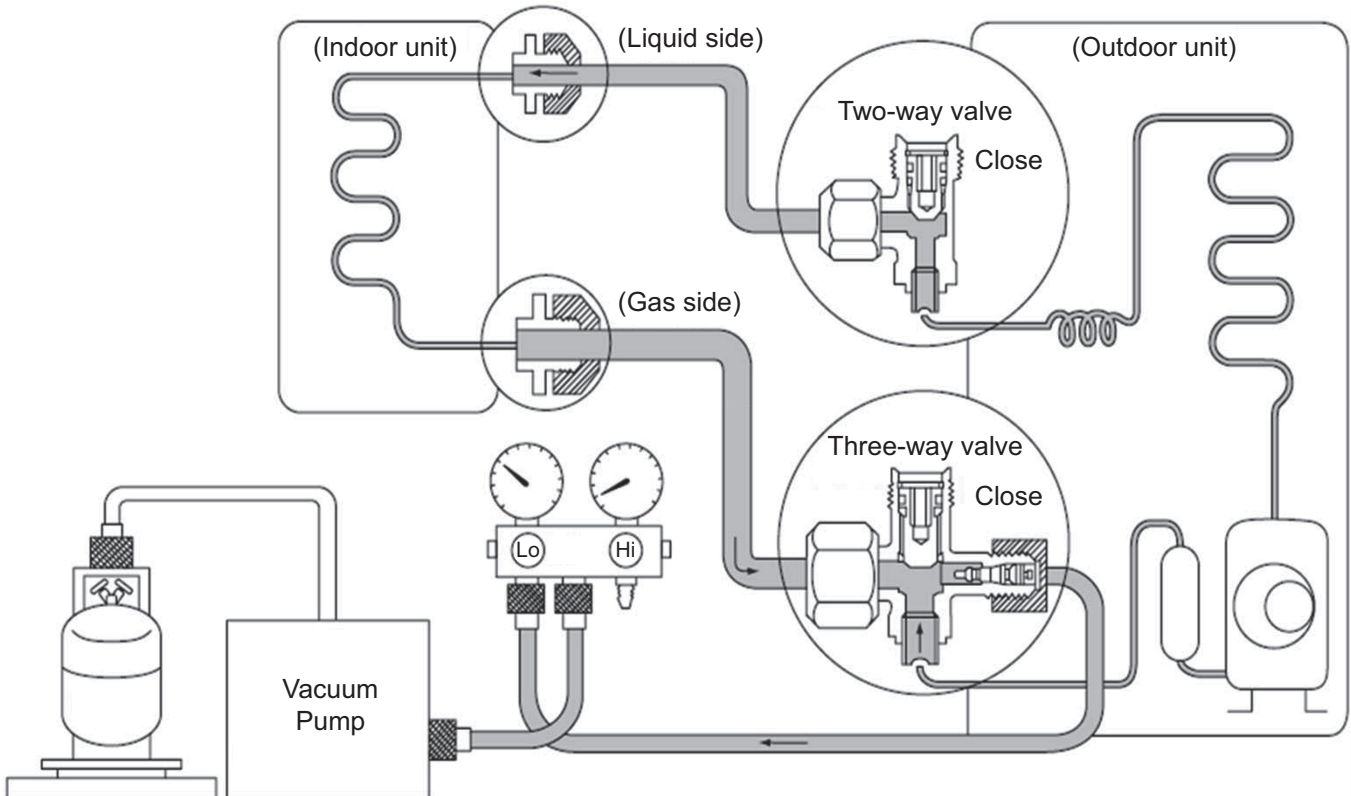

13.6.3 Relocation

1. Removing the air conditioning unit

a) Recovery of outdoor unit refrigerant by pumping down

Press “forced cooling button” (as a general rule, since 1998 the name of cooling testing button is changed, and this name is unified within the air conditioning industry), and then you are able to start cooling operation in which the room temperature is low, and you can recover the refrigerant from the outdoor unit.

1. Check the valve stems of two-way and three-way valves are open by being turned to anti-clockwise (Remove the caps, and confirm the bars are fully open. Use hexagon wrench <4 mm> to open and close the valves).
2. Press the “Emergency Operation” button of the indoor units for five seconds and release [Forced cooling operation] (for old models, press “forced cooling” button). Then, operate the air conditioning unit for about 10 minutes.
3. Turn the stem of the two-way valve to the clock-wise and close the valve.
4. After about 2 ~ 3 minutes, turn the stem of the three-way valve quickly to the clock-wise, and stop the operation.

Caution: In the pump down operation, stop the compressor before removing the refrigerant pipes.

If you do not stop the compressor operation, and if the valve is open and remove the refrigerant pipes, the air may be sucked into the system and causes extreme high temperature in the refrigerant cycle. This may result in rupture or injury, etc.

5. Attach and tighten the caps of two-way and three-way valves with torque wrench.
6. Remove the connecting pipes (liquid side and gas side).

b) Removal of indoor and outdoor units

1. Remove the connecting pipes and wires between the indoor and outdoor units.
2. Attach capping flare nuts on the edges of the pipes, connecting the indoor and outdoor units, in order to prevent dust and moisture get into the pipes.
3. Remove the indoor and outdoor units.

2. Unit installation

Use new refrigerant pipes for the installation, and perform air purging using vacuum pump and gas leakage testing stated in 14.5.1.

13.6.4 Replacement of air conditioning units and evacuation (when re-using the existing pipes)

When replacing the air conditioning units, you might use the existing pipes, but it is recommended to perform flaring again. In case of unit replacement, even if the unit is new refrigerant air conditioner, if the refrigerant oil is different, it may cause problem. Further, when re-using the existing refrigerant pipes, it is recommended to evacuate the pipes as much as possible, due to the reason that much refrigerant oil may be attached on the surface of the pipes. If the pipes are used without evacuation, the remaining refrigerant oil may cause under-performance and abnormal refrigerant cycle caused by non-compatibility of those oils.

13.6.5 Inter-changeability of refrigerant

Do not operate air conditioning units inserting wrong (or mixed) refrigerant (R22, R410A, R32). It may cause malfunction of the units, and at the same time, may cause serious incident such as rupture of the refrigerant cycle.

13.6.6 Re-insertion of refrigerant in service

When re-insertion is needed, follow the procedures to ensure the insertion of new refrigerant at correct amount.

1. Attach charging hose (blue) to the service port of the outdoor unit.
2. Attach charging hose (red) to the vacuum pump. Fully open the 2-way and 3-way valves.
3. Place the refrigerant cylinder on the digital scale for refrigerant charging and connect the charge hose (yellow) to the connection port of the vacuum pump and the digital scale. Leave the cylinder valve fully open.
4. Fully open the handles Lo and Hi of the manifold gauge, and switch on the vacuum pump, and then perform evacuation for at or more than one hour.
5. Confirm the compound gauge of -0.1 MPa (-76 cmHg) and fully open the handles of Lo and Hi, and switch off the vacuum pump. Leave it for about 1 ~ 2 minutes and confirm the needle of the compound gauge does not turn back.

Refer to the picture below to follow the procedures below.

6. Remove the charging hose (red) of the manifold gauge from the vacuum pump adaptor.
7. After adjusting the digital scale to zero, open the cylinder valve and the valve Lo of the manifold gauge, and insert the refrigerant.
8. If it is not possible to insert the refrigerant at regulated amount at once, operate the cooling mode and gradually insert the refrigerant (recommended amount approx. $150 \text{ g} / 1 \text{ time}$)
*Do not insert much refrigerant at once.
9. Close the open/close valve and insert the refrigerant in the charging hose to the outdoor unit.
*Perform this procedure during operating cooling operation. Close the stem of the two-way valve, and when the pressure of the manifold gauge becomes zero (0), quickly remove the charging hose (blue). Immediately open the 2-way valve, and stop the cooling operation.
10. Final checking • • • Confirm the 2-way and 3-way valves are fully open.
Attach the caps of the service port and control valve, and then check the gas leakage around the caps.

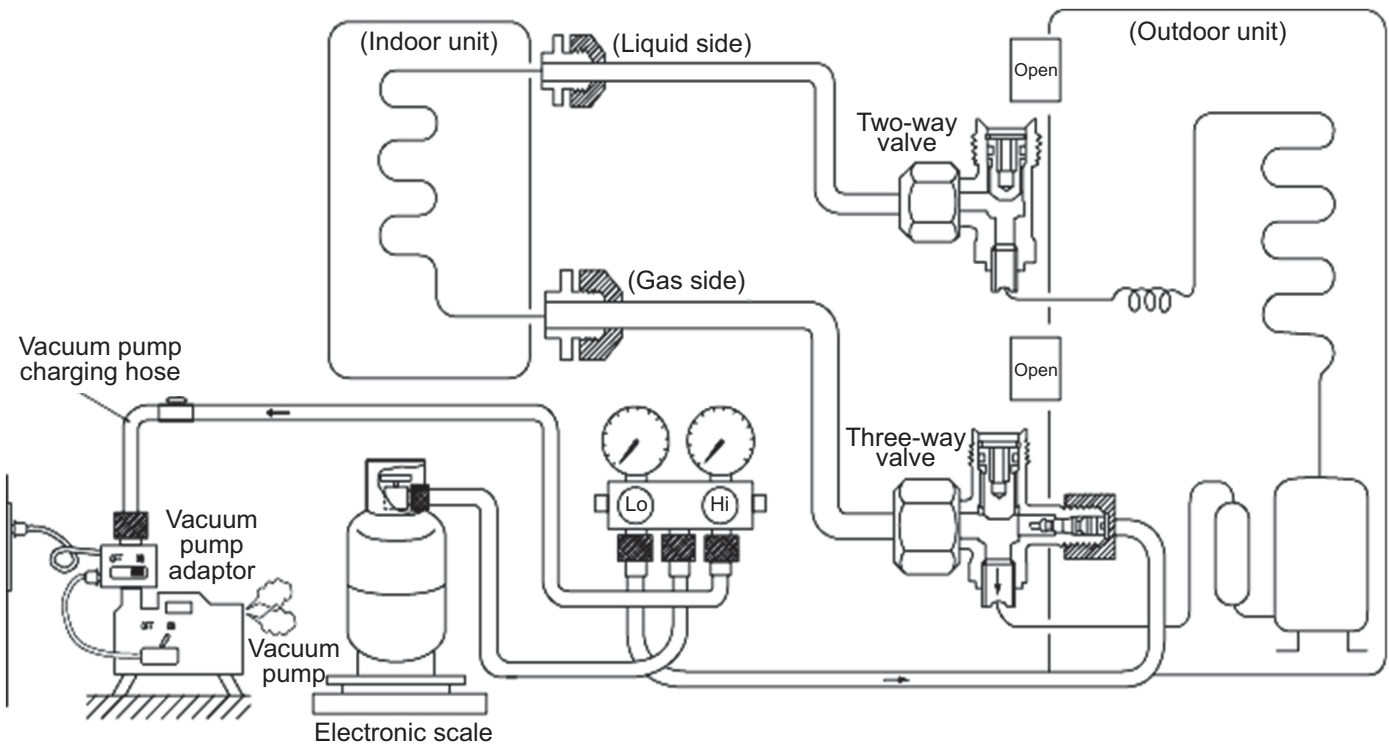

13.7 Repairing of refrigerant cycle / Brazing point

13.7.1 Preparation for repairing of refrigerant cycle / brazing

Brazing which is a technique needed for repairing refrigerant cycle requires advanced technique and experience, and this brazing procedure can only be performed by the workers who completed "Gas Welding Skill Training" regulated by the Occupational Safety and Health Act, and went through the training programs of refrigerant operations.

Dismantling and re-connecting (assembling) refrigerant system requires working space, and the space has to ensure good air flow and fire prevention (water bucket and fire extinguisher). Moreover, the worker has to ensure the wearing of goggles, gloves, safety shoes, and long sleeve shirts, and be aware of work safety and attempt to prevent secondary defect (quality assurance of products). For brazing the indoor / outdoor unit structural components (heat exchangers, compressors, expansion valves, four-way valve blocks), after the recovery of all refrigerant, confirm that no refrigerant remains in the system, and fully open the 2-way and 3-way valves. When the brazing is conducted outside, check and make sure no refrigerant is contained in the air (be careful with vaporized refrigerant).

Furthermore, protect the compressor terminal with metal plates, and heat but use wet clothes to cool down (releasing the heat) the expansion valves, and four way valves (prevent destruction of parts). In brazing, it is important to pour the brazing material without melting the base metal based on capillary action principle. In case of holes and oxidizing caused by overheating, do not perform re-brazing or alteration but replace the parts.

13.7.2 Adjustment of vacuum pump pressure

1. Cylinder with adjustment handle

1. Check and confirm the adjustment handle of the 1st pressure adjuster is loosen (anticlockwise). If cylinder valve is opened when the 1st gauge pressure adjust handle is closed, the 2nd gauge might get broken.

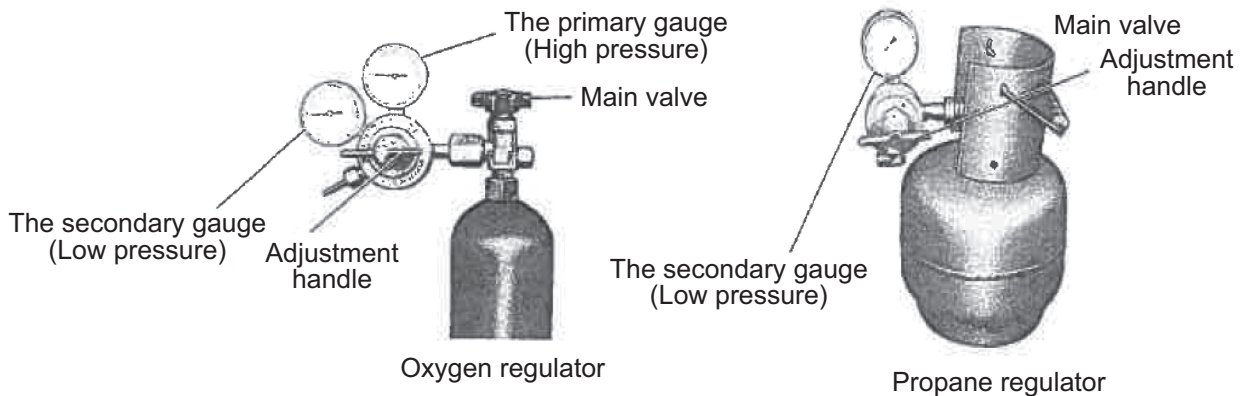

2. Open the cylinder valve, and check the remaining amount with the first side pressure gauge.
3. Check the pressure of 2nd gauge and turn the adjustment handle to clock-wise direction to adjust the pressure.
 - ⊙ Oxygen 2nd side gauge pressure 0.5 MPa (5.0 kgf / cm²)
 - ⊙ Propane 2nd side gauge pressure 0.05 MPa (0.5 kgf / cm²)

2. Cylinder without adjustment valve
 2nd side gauge pressure is adjusted by the adjuster.
 Check the both side valves of the torch and open the cylinder valve to check the remaining refrigerant in the cylinder.
 Caution: Do not attach oil component on the connection port of the adjuster.
 Especially, use an oxygen cylinder adjuster which is no oil substance type. Do not dismantle or repair the adjuster and pressure gauge.

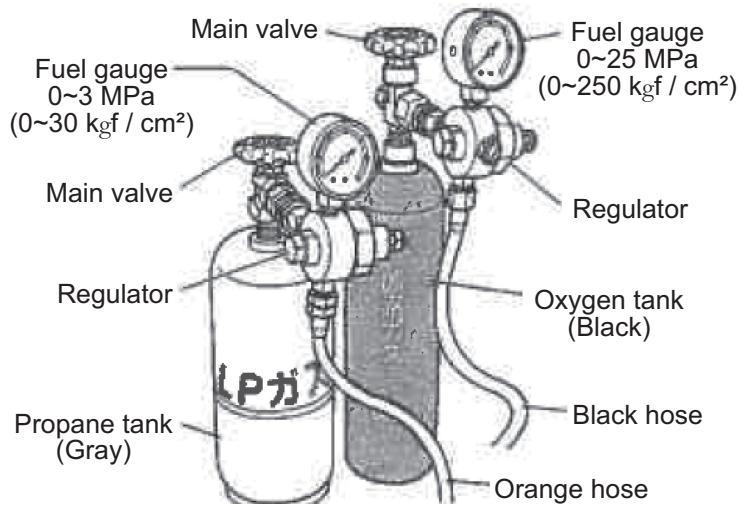

13.7.3 Checking of gas provision

Checking there is no fire around the torch, and then confirm the provision of gas.

1. Slightly open the "propane valve" of the torch, and make sure the gas comes out from the torch crater and then close the "propane valve".
 2. Slightly open the "oxygen valve" of the torch and make sure the gas comes out from the torch crater and then close the "oxygen valve".
- Check there is no gas leakage around the hose connection.

13.7.4 Adjustment of flame

1. Slightly open the "propane valve" of the torch and lit with spark lighter.
 This moment, the flame is only by propane and the color is red.
 2. Gradually open the "oxygen valve" of the torch to mix oxygen, and adjust the amount of propane and oxygen with the valve to make the flame suitable for brazing work.
- If the white core flame splits into two, the torch crater might be clogged. In this case, remove the crater from the torch and check.

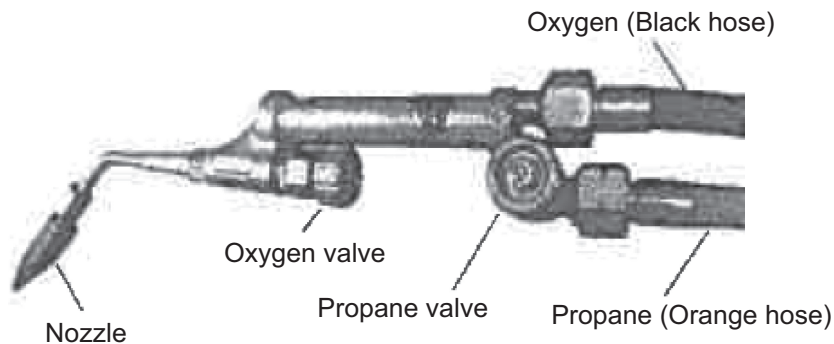

13.7.5 Types of flame

Types of flame change based on the proportion of propane and oxygen.

[Neutral Flame]

Perform brazing with this flame

(This is a flame when oxygen and propane are mixed at proper proportion, and has lesser effect on the brazed metals)

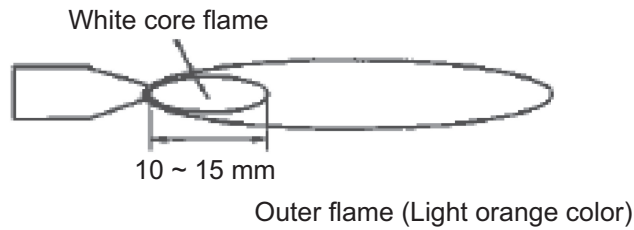

[Carbide Flame]

When propane is excessive, the flame has white color flame in between the white core flame and outer flame. (This is due to the lack of oxygen and the proportion of unburned propane is excessive. The black carbon created during the brazing work may contaminate the surface of the brazed metal).

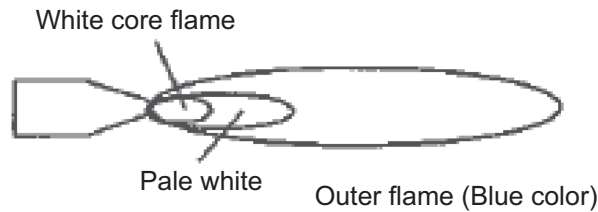

[Oxidizing Flame]

Oxygen is more compared to the neutral flame. Although the flame size is small, this has the highest flame heat. However, due to the excessive oxygen contained in the flame, the brazing point gets oxidized. (This flame may cause holes, due to the high heat. The pipe may get melt)

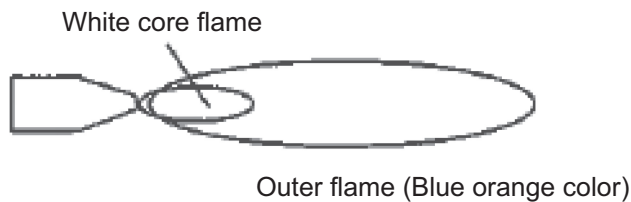

13.7.6 Closing the flame

[In case of short break]

1. Close the "propane valve" of the torch.
2. Close the "oxygen valve" of the torch.

[In case of finishing work]

1. As above, close the flame following the procedure of "In case of short break"
2. Completely close the valves of oxygen and propane cylinders
3. Release the remaining gas inside the hose by opening the "oxygen valve" and "propane valve" of the torch.
4. Confirm the 1st and 2nd side gauge pressures of "oxygen" and "propane" cylinder pressure adopter are "zero".

13.7.7 Selection of brazing material

Use BA_g brazing material (silver solder) to increase the welding performance.

Category	JIS Standard Number	Composition of ingredients (%)						Temperature (°C)			Tensile strength (Reference)		Characteristics and applications
		Ag	Cu	Zu	Cd	Ni	P	Solidus	Liquidus	Brazing temp	Kgf•cm ²	Base material	
BA _g	BA _g • 1A	49.0 ~ 51.0	14.5 ~ 16.5	14.5 ~ 18.5	17.0 ~ 19.0	—	—	approx. 625	approx. 635	635 ~ 760	45.5	S20C	Liquidity is good at low temperature, it is preferable to a small junction of the gap in the universal form.
	BA _g • 1	44.0 ~ 56.0	14.0 ~ 16.0	14.0 ~ 18.0	23.0 ~ 25.0	—	—	approx. 605	approx. 620	620 ~ 760	45.5	S20C	It has similar performance to the BA _g • 1A, and suitable for every base material except the light weight metal.
	BA _g • 2	34.0 ~ 36.0	25.0 ~ 27.0	19.0 ~ 23.0	17.0 ~ 19.0	—	—	approx. 605	approx. 700	700 ~ 845	45.5	S20C	It is a brazing filler metal in universal form, suitable for a slightly larger gap junction.
	BA _g • 3	48.0 ~ 51.0	14.5 ~ 16.5	13.5 ~ 17.5	15.0 ~ 17.0	2.5 ~ 3.5	—	approx. 630	approx. 690	690 ~ 815	35 ~ 70	SS ~ SUS	It has good corrosion resistance in stainless steel-based brazing, suitable for brazing tungsten carbide, aluminum bronze and copper.
BCuP	BCuP-2	—	remain	—	—	—	6.8 ~ 7.5	approx. 710	approx. 785	690 ~ 815	21 ~ 24.5	Cu	Good liquidity, suitable for brazing copper tube.
	BCuP-3	4.8 ~ 5.2	remain	—	—	—	5.8 ~ 6.7	approx. 645	approx. 815	720 ~ 815	21 ~ 24.5	Cu	Suitable for brazing when the joint spacing is not constant
	BCuP-5	14.5 ~ 15.5	remain	—	—	—	4.8 ~ 5.3	approx. 645	approx. 800	705 ~ 815	21 ~ 24.5	Cu	When brazing of copper and copper, it is used without a flux, but not possible for brazing basic materials

Caution

BCuP (phosphorus copper wax) is easy to react with sulfur, and makes a brittle compound water soluble, and causes gas leakage. In hot spring areas, use other brazing materials or paint the surface for protection.

13.7.8 Need of flux

Use flux to protect the base materials.

1. Remove impurity and oxide film on the metal base, and improve the flow of the brazing material.
2. Prevent oxidation of the metal surface in brazing.
3. Reduce the surface tension of the brazing material.

13.7.9 Need of nitrogen gas

In order to prevent oxidation in the pipe, perform the brazing operation in nitrogen gas flow. Flow rate 0.05 m³ / h, or pressure reducing valve at 0.02 MPa (0.2kgf / cm²) below.

13.7.10 Checking of brazing (insert) points

1. No impurity on the brazing point
If dirt or oil is attached on the brazing point, the brazing filler metal does not reach to junction, and it may cause poor welding.
2. Adequate gap space in the brazing point
The advantage of capillary current situation is used in brazing. If the gap space is too large, this phenomenon may not occur and it may cause poor welding because brazing filler metal does not flow to join the front part.

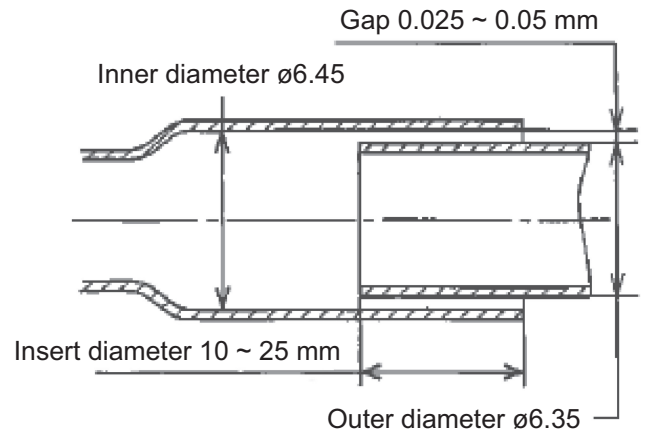

3. Appropriate size for insertion
The guideline for pipe insertion dimensions is to three times the diameter of the base material, but you need to decide the insertion size in consideration of the clogging of the brazing material. Generally, for thin pipes, you need to increase the insert size, and for thick pipe vice versa.

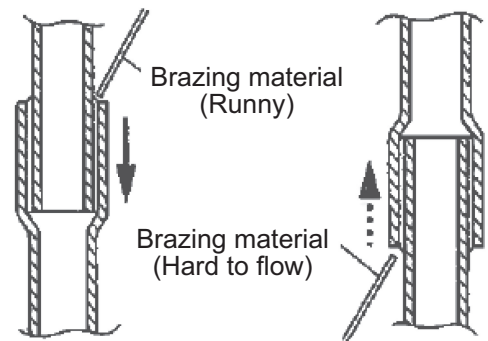

4. Brazing material to flow from top to bottom
Brazing filler metal will easily flow to the connecting portion by capillary action. Further, by bending the brazing portion of [dryer side] of the capillary tube at 15 mm from the tube top to the angle of about 120°, you can prevent the damage of dryer inside and the clogging of brazing material caused by the excessive insertion of capillary tube.

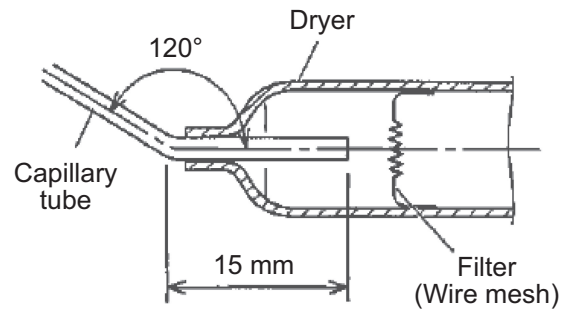

13.7.11 Brazing and heating

1. Place the flame to a pipe which has more heat capacity in order to let the brazing material melt by the pipe heat. Heat the pipe up to the melting temperature of the brazing material, but when it is overheating, assess the temperature by pipe color in order not to melt the pipe.

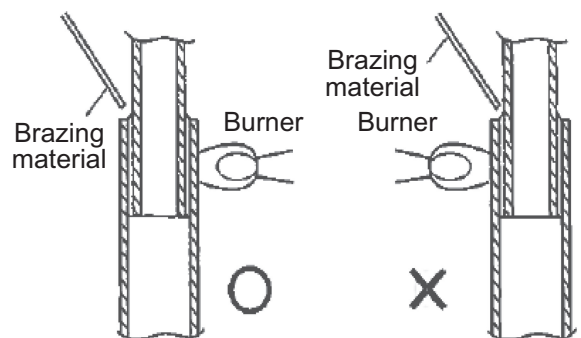

The pre-heating is to heat the base material until the melting temperature, and requires certain training to distinguish the color of the heated base material in order not to melt the material.

The color and temperature of copper tube

- Becoming red color •••••••• 480°C
- Dull red •••••••• 650°C
- Cherish red •••••••• 760°C
- Brightening cherish red •••••••• 870°C

(Reference)

Melting temperature of copper ••••••• Approx. 1083°C

Maximum temperature obtained in propane and oxygen ••••••• Approx. 1083°C

The important point is to heat the bonding part uniformly within a short period of time until reaching to the brazing temperature in the following manner.

2. Apply the flame on to the side with better heat transmission. If the pipe thickness is consistent, by heating like 30% iron and 70% copper, the copper pipe inside reaches to brazing temperature. Iron pipes have low heat transmission and only the part the flame is applied get high temperature, and this causes oxidization of the pipe. The flow of the brazing filler is affected negatively.

3. Apply the flame on to the side of larger heat capacity.

When brazing a thin tubes such as capillary tube and dryer, etc., caution has to be taken to apply the flame to the dryer side (thick pipe side), in order to prevent burn out by the heat.

4. When brazing the compressor connection pipes (suction and discharge), remove the sound insulation plate and the fan, and place the compressor stand vertically (to prevent the leakage of compressor refrigerating machine oil), and apply the flame from the compressor body side.

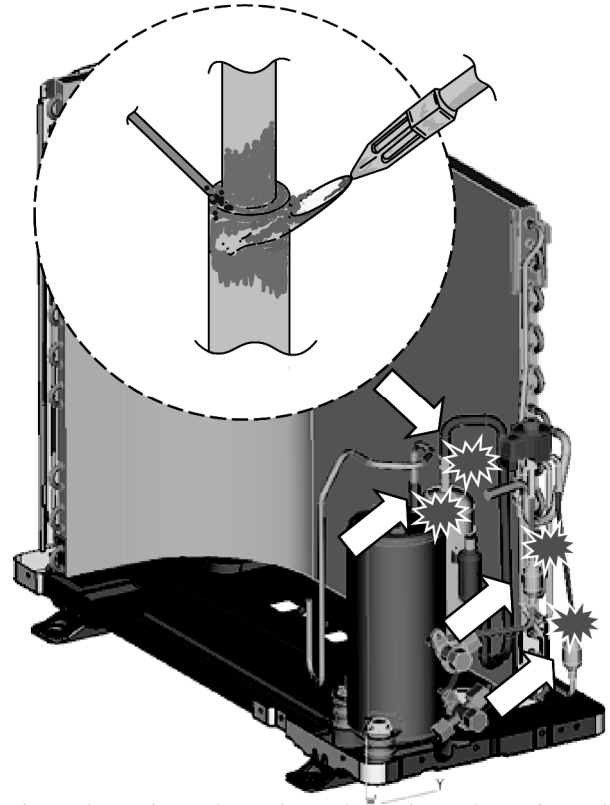

13.7.12 Terminologies of brazing

Pin holes → Small holes are generated on the surface of the brazing metal.

Wet temperature → Liquidus temperature at which the brazing material starts flowing out by heating, generally it is the liquidus-line temperature.

Blow holes → Hollows made by gas in the brazing material of brazing portion (gas reservoirs).

Pits → As a result of blow holes, small dents generated on the outside surface of welding.

Voids → The brazing material does not reach completely to the brazing part. It cannot be identified from outside.

13.8 <Reference> Analysis method for no error code, no cooling / no warming

13.8.1 Preparation for appropriate diagnosis

In order to obtain appropriate operation characteristics, minimum 15 minutes or more operation time [testing operation (rated operation)] is required.

1. Method of rated operation (rated operation)

For the models which have two buttons of “emergency operation and forced cooling operation”, press forced cooling button once. For the models which have only emergency operation button, press the button once for 5 seconds and when hear “beep” sound, release the button. Then, cooling operation starts.

2. Checking the mal-functions of indoor / outdoor units

- 1) Any obstacles against heat release and air suction? (short circuit)
(Forget to remove the outdoor unit cover or fallen leaves blocking the outdoor unit)
- 2) Are the indoor unit air filters clean? (obstructing heat suction)
- 3) Is the setting temperature on the remote controller correct? (is the setting temperature set at lower/higher than the room temperature?)

13.8.2 Understanding and verification of refrigerant cycle

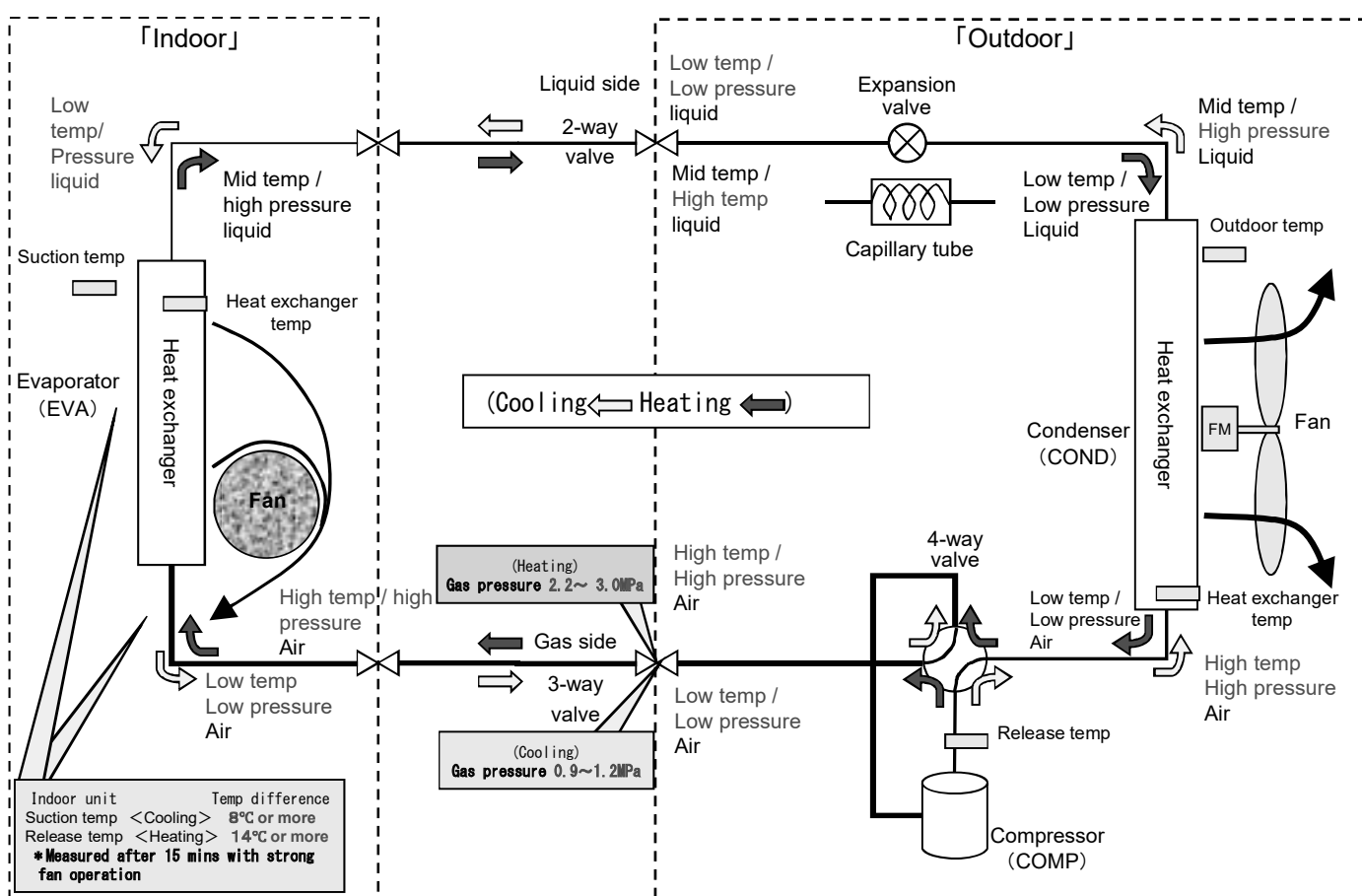

1. Measuring temperature

- 1) Indoor unit suction temperature, release temperature, temperature difference, → Measure by thermometer
- 2) 2-way valve pipe temperature in cooling mode is low temperature (benchmark : 5 ~ 10°C), in heating mode is medium temperature (benchmark : 25 ~ 35°C).
- 3) 3-way valve pipe temperature in cooling mode is low temperature (benchmark : 7 ~ 15°C) in heating mode is high temperature (benchmark : 38 ~ 50°C).

2. Measuring electric current

- Measuring electric current in operation → check by clamp meter (refer to table of technical characteristic guideline)

3. Measuring pressure

- Measuring gas pressure → check the pressure by manifold gauge (refer to table of technical characteristic guideline)

4. Any sound from the expansion valve?
 (when starting the operation and the outdoor unit is turned on, the expansion valve is re-set, check if there is any edged sound or clack sound)

13.8.3 Guidance for diagnosis of refrigerant cycle

Comparison with normal operation	Cooling mode	
	High	Low
Refrigerant pressure	Excess insertion of refrigerant	Clogged capillary, expansion valve malfunction
	Heat releasing obstruction	Clog by moisture
	Dirty condenser, attachment of impurity	Lack of refrigerant gas
	Compressor malfunction	
Operation electric current	Excess insertion of refrigerant	Lack of refrigerant gas
	Heat releasing obstruction	Compressor malfunction
	Dirty condenser, impurity	Mixture of air
		(Insufficient evacuation)
2-way valve temperature	Excess insertion of refrigerant	Clogged capillary, expansion valve malfunction
	Compressor malfunction	Lack of refrigerant gas
3-way valve temperature	Lack of refrigerant gas • Compressor malfunction	Excess insertion of refrigerant
	Clogged capillary, expansion valve malfunction	

Suction temperature & Release air temperature	Temperature difference at or less than 8°C in cooling operation • • • Causes		
	• Heat releasing obstruction	• Dirty condenser	• Attachment of impurity
	• Lack of refrigerant gas	• Excess insertion of refrigerant	
	• Mixture of air	• Mixture of moisture	
	• Clogged capillary	• Expansion valve malfunction	• Compressor malfunction

- ◎ Above all are based on the condition that the installation work is properly performed (no issues in indoor / outdoor pipe connections, etc.)

14. Operation Control

14.1 Basic Function

Inverter control, which equipped with a microcomputer in determining the most suitable operating mode as time passes, automatically adjusts output power for maximum comfort always. In order to achieve the suitable operating mode, the microcomputer maintains the set temperature by measuring the temperature of the environment and performing temperature shifting. The compressor at outdoor unit is operating following the frequency instructed by the microcomputer at indoor unit that judging the condition according to internal setting temperature and intake air temperature.

14.1.1 Internal Setting Temperature

Once the operation starts, remote control setting temperature will be taken as base value for temperature shifting processes.

These shifting processes are depending on the air conditioner settings and the operation environment. The final shifted value will be used as internal setting temperature and it is updated continuously whenever the electrical power is supplied to the unit.

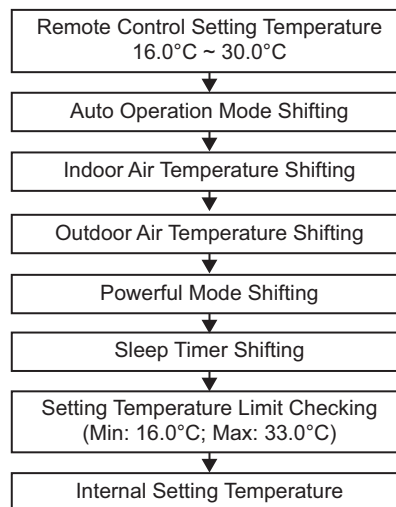

14.1.2 Cooling Operation

14.1.2.1 Thermostat control

- Compressor is OFF when Intake Air Temperature - Internal Setting Temperature $< -1.5^{\circ}\text{C}$ continue for 3 minutes.
- When compressor is OFF (Thermostat OFF) and AUTO FAN is set, the fan will stop periodically.
- Compressor is ON after waiting for 3 minutes, if the Intake Air Temperature - Internal Setting Temperature $>$ Compressor OFF point.

14.1.3 Soft Dry Operation

14.1.3.1 Thermostat control

- Compressor is OFF when Intake Air Temperature - Internal Setting Temperature $< -2.0^{\circ}\text{C}$ continue for 3 minutes.
- When compressor is OFF (Thermostat OFF) and AUTO FAN is set, the fan will stop periodically.
- Compressor is ON after waiting for 3 minutes, if the Intake Air Temperature - Internal Setting Temperature $>$ Compressor OFF point.

14.1.4 Heating Operation

14.1.4.1 Thermostat control

- Compressor is OFF when Intake Air Temperature - Internal Setting Temperature $> +1.5^{\circ}\text{C}$ continue for 3 minutes.
- Compressor is ON after waiting for 3 minutes, if the Intake Air Temperature - Internal Setting Temperature $<$ Compressor OFF point.

14.1.5 Automatic Operation

- This mode can be set using remote control and the operation is decided by remote control setting temperature, remote control operation mode and indoor intake air temperature.
- During operation mode judgment, indoor fan motor (with speed of Lo-) is running for 30 seconds to detect the indoor intake air temperature.
- Every 10 minutes, the indoor temperature is judged.
- For the 1st judgment
 - If indoor intake temperature - remote control setting temperature $\geq 2.0^{\circ}\text{C}$, COOL mode is decided.
 - If $-2.0^{\circ}\text{C} \leq$ indoor intake temperature - remote control setting temperature $< 2.0^{\circ}\text{C}$, DRY mode is decided.
 - If indoor intake temperature - remote control setting temperature $< -2.0^{\circ}\text{C}$, HEAT mode is decided.

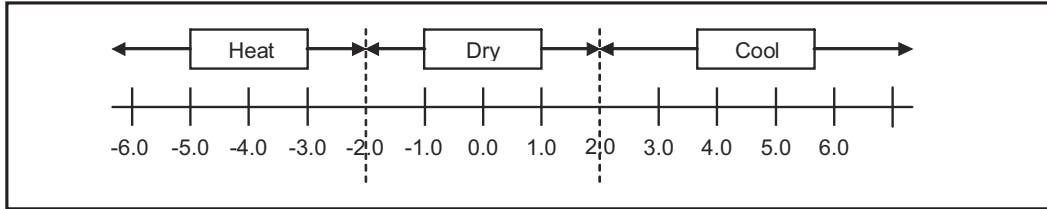

- For the 2nd judgment onwards
 - If indoor intake temperature - remote control setting temperature $\geq 3.0^{\circ}\text{C}$, if previous operate in DRY mode, then continue in DRY mode. otherwise COOL mode is decided.
 - If $-2.0^{\circ}\text{C} \leq$ indoor intake temperature - remote control setting temperature $< 3.0^{\circ}\text{C}$, maintain with previous mode.
 - If indoor intake temperature - remote control setting temperature $< -2.0^{\circ}\text{C}$, HEAT mode is decided.

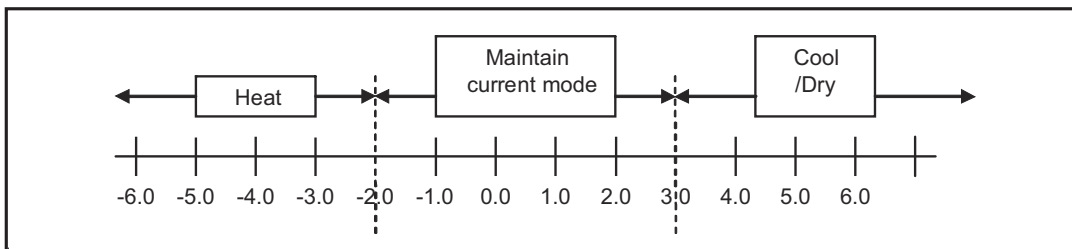

14.1.6 Fan Operation

- Fan Operation is used to circulate air in a room.
- During operation, indoor fan run continuously but outdoor fan and compressor stop.
- Temperature setting is not applicable.

14.2 Indoor Fan Motor Operation

A. Basic Rotation Speed (rpm)

i. Manual Fan Speed

[Cooling, Dry, Fan]

- Fan motor's number of rotation is determined according to remote control setting.

Remote control	○	○	○	○	○
Tab	Hi	Me+	Me	Me-	Lo

- When thermostat off, the fan speed will be limited to max Me fan.
- In COOL mode, when the room temperature reaches near the set temperature, the compressor stops, then the indoor unit fan speed reduced.
- To prevent the room humidity rising, the indoor fan will resume running according to the set fan speed when room temperature increase.

[Heating]

- Fan motor's number of rotation is determined according to remote control setting.

Remote control	○	○	○	○	○
Tab	SHi	Me+	Me	Me-	Lo

ii. Auto Fan Speed

[Cooling, Dry]

- According to room temperature and setting temperature, indoor fan speed is determined automatically.
- When set temperature is not achieved, the indoor fan will operate according to pattern below.

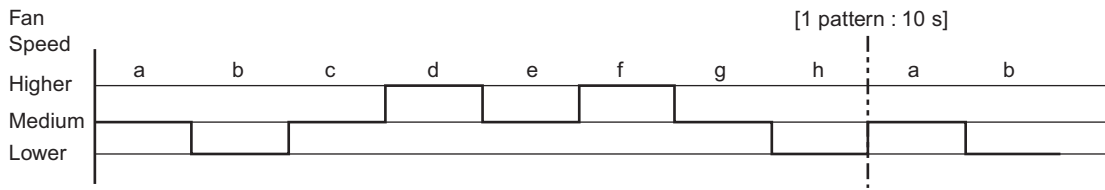

- When set temperature achieved, the indoor fan speed will be fixed. When thermostat off, the fan stop periodically.

[Fan]

- Indoor fan speed is fixed at predetermined speed.

[Heating]

- According to indoor pipe temperature, automatic heating fan speed is determined as follows.

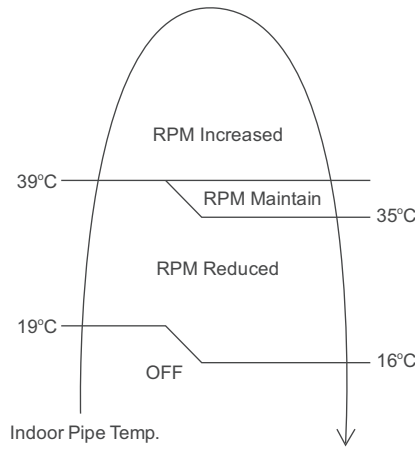

B. Feedback control

- Immediately after the fan motor started, feedback control is performed once every second.
- During fan motor on, if fan motor feedback ≥ 2550 rpm or < 50 rpm continue for 10 seconds, then fan motor error counter increase, fan motor is then stop and restart. If the fan motor counter becomes 7 times, then H19 - fan motor error is detected. Operation stops and cannot on back.

14.3 Outdoor Fan Motor Operation

It starts when compressor starts operation and it stops 30 seconds after compressor stops operation.

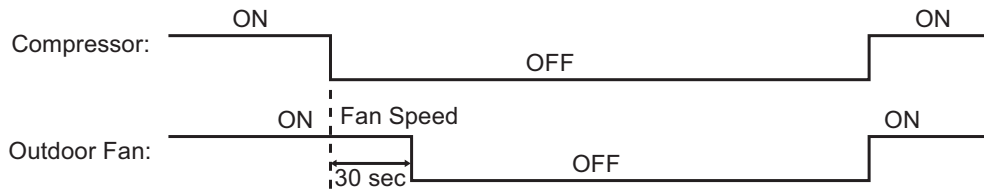

14.4 Airflow Direction

1. There are two types of airflow, vertical airflow (directed by horizontal vane) and horizontal airflow (directed by vertical vanes).
2. Control of airflow direction can be automatic (angles of direction is determined by operation mode, heat exchanger temperature and intake air temperature) and manual (angles of direction can be adjusted using remote control).

14.4.1 Vertical Airflow

Operation Mode	Airflow Direction		Upper Vane Angle (°)					Lower Vane Angle (°)				
			1	2	3	4	5	1	2	3	4	5
Cooling/Dry/Fan	Auto	Not yet achieve set temperature	7 ~ 40					4 ~ 45				
		Achieve set temperature	7					4				
	Auto Swing		7 ~ 40					4 ~ 45				
	Manual		7	15	20	30	40	4	14	25	34	45
Heating	Auto with Heat Exchanger Temperature	A	15					19				
		B	54					43				
		C	20					25				
	Auto Swing		20 ~ 56					25 ~ 49				
	Manual		15	20	35	50	56	19	25	34	43	49

1. Automatic vertical airflow direction can be set using remote control; the vane swings up and down within the angles as stated above. For heating mode operation, the angle of the vane depends on the indoor heat exchanger temperature as Figure 1 below. It does not swing during fan motor stop. When the air conditioner is stopped using remote control, the vane will shift to close position.
2. Manual vertical airflow direction can be set using remote control; the angles of the vane are as stated above and the positions of the vane are as Figure 2 below. When the air conditioner is stopped using remote control, the vane will shift to close position.

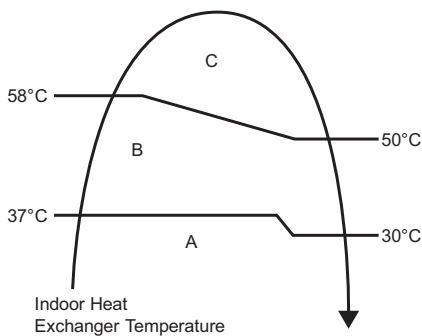
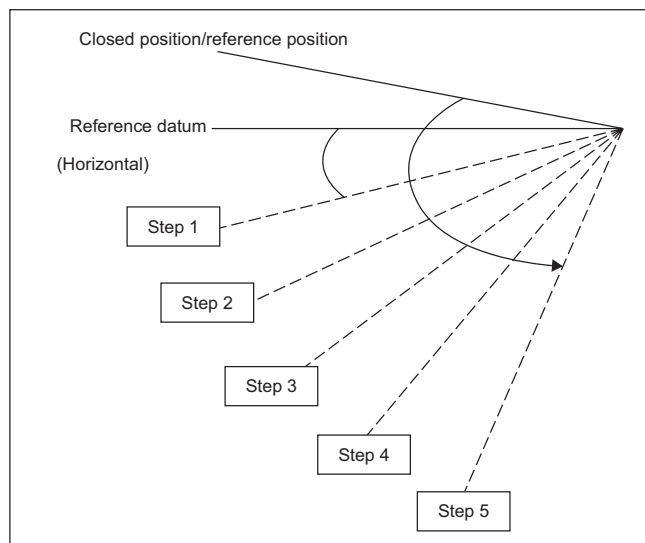

Figure 1



* The horizontal vane angle tolerance is within +/- 5 degree.

14.4.2 Horizontal Airflow

- Automatic horizontal airflow direction can be set using remote control; the vane swings left and right within the angles as stated below. For heating mode operation, the angle of the vane depends on the indoor heat exchanger temperature as Figure 1 below. It does not swing during fan motor stop.

Operation Mode		Vane Angle (°)
Heating, with heat exchanger temperature	A	60 ~ 120
	B	90
Cooling, Fan and Soft Dry		60 ~ 120

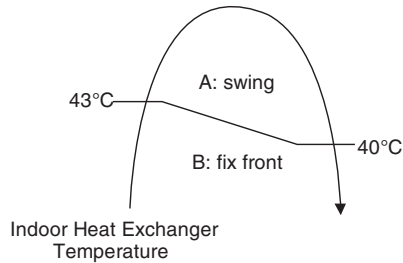

Figure 1

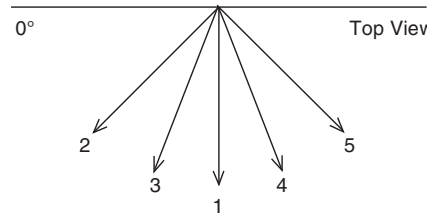

Figure 2

- Manual horizontal airflow direction can be set using remote control; the angles of the vane are as stated below and the positions of the vane are as Figure 2 above.

Pattern	1	2	3	4	5
Airflow Direction Patterns at Remote Control					
Vane Angle (°)	90	60	75	105	120

* The vertical vane angle tolerance is within +/- 5 degree.

14.5 Quiet Operation (Cooling Mode/Cooling Area of Dry Mode)

A. Purpose

To provide quiet cooling operation compare to normal operation.

B. Control condition

a. Quiet operation start condition

- When "FAN SPEED/QUIET" button at remote control is pressed continuously until QUIET will be shown on remote control display.

b. Quiet operation stop condition

- When one of the following conditions is satisfied, quiet operation stops:

- POWERFUL button is pressed.
- Stop by OFF/ON switch.
- Timer "off" activates.
- When FAN SPEED/QUIET button is pressed again and fan speed is change to Low.
- +8/15°C Heat is activated.
- Sleep mode timer delay OFF.

- When quiet operation is stopped, operation is shifted to normal operation with previous setting.
- When operation mode is changed, quiet operation is shifted to quiet operation of the new mode.
- During quiet operation, if timer "on" activates, quiet operation maintains.
- After off, when on back, quiet operation is memorised.

C. Control contents

- Fan speed is changed to QLo.

14.6 Quiet Operation (Heating)

A. Purpose

To provide quiet heating operation compare to normal operation.

B. Control condition

a. Quiet operation start condition

- When “FAN SPEED/QUIET” button at remote control is pressed continuously until QUIET will be shown on remote control display.

b. Quiet operation stop condition

1. When one of the following conditions is satisfied, quiet operation stops:

- a. POWERFUL button is pressed.
- b. Stop by OFF/ON switch.
- c. Timer “off” activates.
- d. When FAN SPEED/QUIET button is pressed again and fan speed is change to Low.
- e. +8/15°C Heat is activated.
- f. Sleep mode timer delay OFF.

2. When quiet operation is stopped, operation is shifted to normal operation with previous setting.

3. When operation mode is changed, quiet operation is shifted to quiet operation of the new mode.

4. During quiet operation, if timer “on” activates, quiet operation maintains.

5. After off, when on back, quiet operation is memorised.

C. Control contents

1. Fan speed is changed to QLo.

14.7 Powerful Mode Operation

- When the powerful mode is selected, the internal setting temperature will shift lower up to 1°C (for Cooling/Soft Dry) or higher up to 1°C (for Heating) than remote control setting temperature to achieve the setting temperature quickly.

14.8 Timer Control

- There are 2 sets of ON and OFF timer available to turn the unit ON or OFF at different preset time.
- If more than one timer had been set, the upcoming timer will be displayed and will activate in sequence.

14.8.1.1 ON Timer Control

- ON timer 1 and ON timer 2 can be set using remote control, the unit with timer set will start operate earlier than the setting time.

This is to provide a comfortable environment when reaching the set ON time.

- 60 minutes before the set time, indoor (at fan speed of Lo-) and outdoor fan motor start operate for 30 seconds to determine the indoor intake air temperature and outdoor air temperature in order to judge the operation starting time.
- From the above judgment, the decided operation will start operate earlier than the set time as shown below.

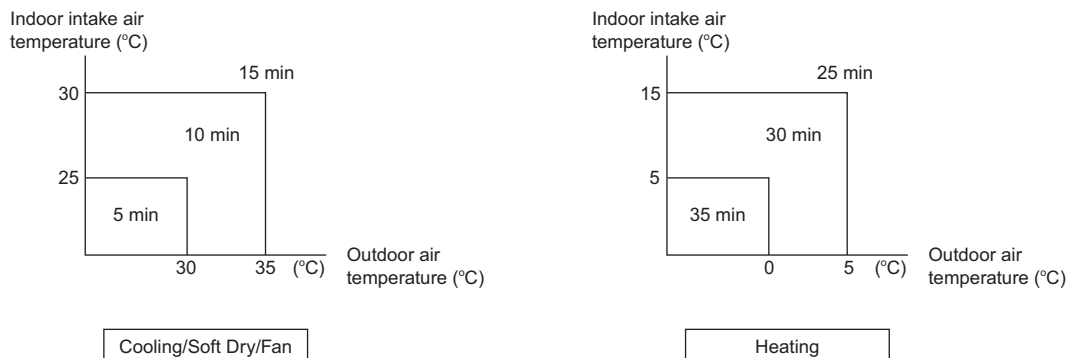

14.8.2 OFF Timer Control

OFF timer 1 and OFF timer 2 can be set using remote control, the unit with timer set will stop operate at set time.

14.9 Sleep Mode Operation

This operation provide comfortable environment while sleeping. It will automatically adjust the sleep pattern temperature during the activation period.

This operation is incorporated with the activation timer (0.5, 1, 2, 3, 4, 5, 6, 7, 8 or 9 hours).

Start Condition:

- Sleep button on remote controller is pressed.
- Select OFF timer: 0.5, 1, 2, 3, 4, 5, 6, 7, 8, 9 hours.

Control content:

- Sleep function maximum running hour is 9 hours.
- When Sleep off timer running out, unit will automatically OFF.
- When unit resume from power failure, Sleep function will not resume.
- Sleep operation can be set together with Timer operation. Sleep operation has priority over OFF Timer.
- Indicator shall be dimmed when this operation is activated.

Control pattern:

- Cooling mode

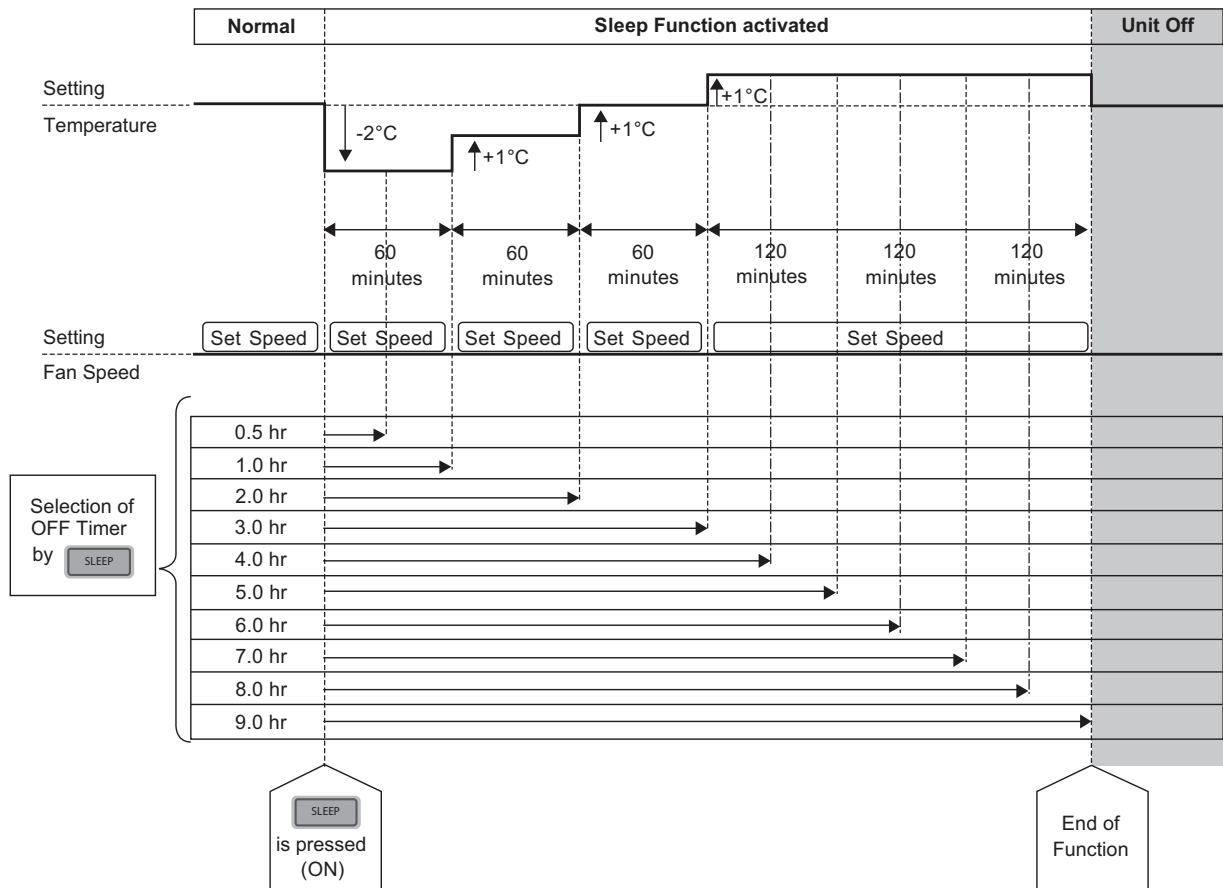

- Heating mode

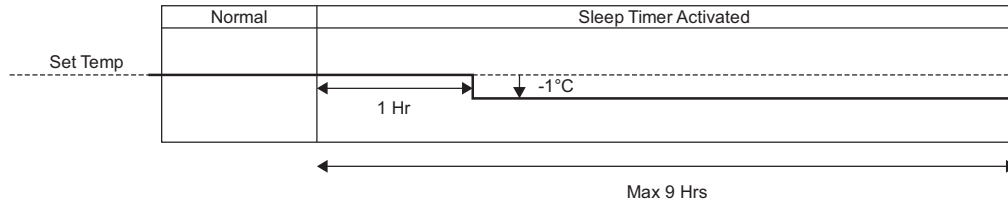

- Sleep operation will not undergo temperature shift when it collaborate with below operation. However, it will execute the delay timer.
 - Powerful mode operation

Stop Condition:

- When sleep operation is cancel by pressing respective button until sleep timer reaches 0.0h.
- ON/OFF button is pressed.

When sleep operation ends.

14.10 Auto Restart Control

1. When the power supply is cut off during the operation of air conditioner, the compressor will re-operate within three to four minutes (there are 10 patterns between 2 minutes 58 seconds and 3 minutes 52 seconds to be selected randomly) after power supply resumes.
2. This type of control is not applicable during ON/OFF Timer setting.
3. This control can be omitted by open the circuit of JP1 at indoor unit printed circuit board.

14.11 Indication Panel

LED	POWER	TIMER	DEICE	+8/15°C HEAT	📶	nanoeX
Color	White	White	White	White	White	White
Light ON	Operation ON	Timer Setting ON	Deice ON	+8/15°C HEAT ON	Wireless LAN Mode ON	nanoe™X Mode ON
Light OFF	Operation OFF	Timer Setting OFF	Deice OFF	+8/15°C HEAT OFF	Wireless LAN Mode OFF	nanoe™X Mode OFF

Note:

- If POWER LED is blinking, the possible operation of the unit are Hot Start, operation mode judgment, or ON timer sampling.
- If Timer LED is blinking, there is an abnormality operation occurs.

14.12 +8/15°C Heat Operation

- +8/15°C Heat operation provides heating at low setting temperature in unoccupied houses during winter for the purpose of protecting equipments or housing appliances which may be destroyed by the extreme cold weather.
- This operation can be ON by pressing the +8/15°C Heat button on the remote control.
- The temperature settings range are;
 - 8.0°C ~ 15.0°C (Pressing TEMP up and TEMP down button at the remote control)
- During the operation of this mode;
 - The indoor fan speed will remain at Hi fan tap all the time included deice process.
 - Powerful operation, Quiet operation and Fan Speed selection are disabled.
 - Cold draft prevention control is disabled.
- Control condition;

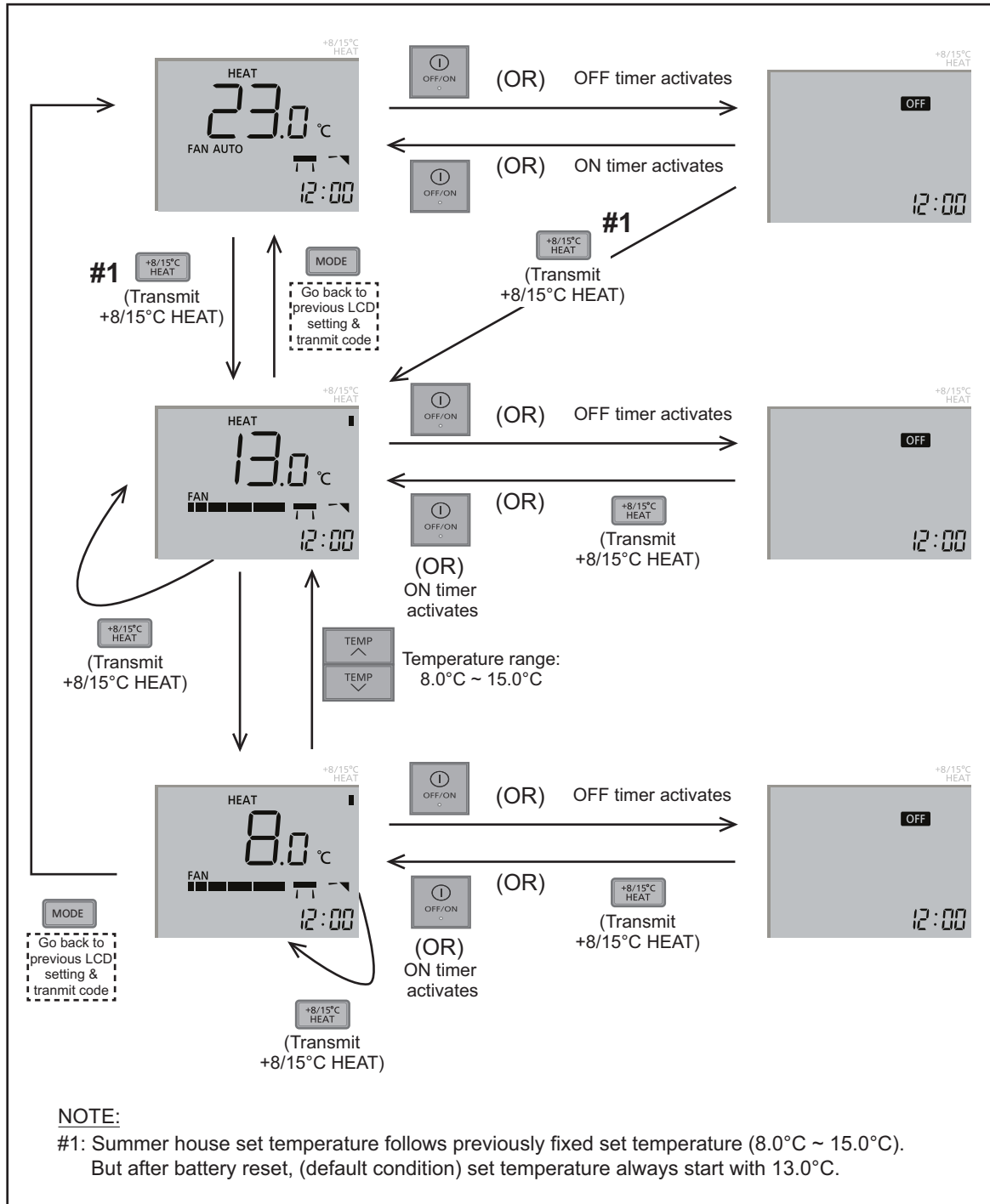

• Caution!

If the indoor temperature constantly is less than 0°C (Door, windows not close properly), the error code F11 may occur. This is because in open area, the indoor sensor will misjudge operation condition and will give error code.

14.13 nanoe™ X Operation

- Generate nanoe™ X (water wrapped ion particle) to moisturize skin, provide deodorization & sterilization effect.
- nanoe™ X operation start condition
 - During unit running at any operation mode, if nanoe™ X operation is activated, combination operation (operation mode + nanoe™ X operation) starts.
 - During unit is OFF, if nanoe™ X operation is activated, nanoe™ X individual operation starts.
- nanoe™ X operation stop condition
 - When OFF/ON button is pressed to stop the operation.
 - When nanoe™ X button is pressed.
 - When OFF Timer activates.
- nanoe™ X operation pause condition
 - When indoor fan stop (during deice, odor cut control, thermostat off, etc.). nanoe™ X operation resume after indoor fan restarts.
 - When indoor intake temperature $\geq 35^{\circ}\text{C}$ and $\leq 5^{\circ}\text{C}$. nanoe™ X operation resume after indoor intake temperature $< 35^{\circ}\text{C}$ or $\geq 5^{\circ}\text{C}$ continuously for 6 minutes.
- Indoor fan control
 - During any operation mode combines with nanoe™ X operation, fan speed follows respective operation mode. However, nanoe™ X system enabled when fan speed ≥ 430 rpm to ensure proper negative ion distribution, nanoe™ X system disabled when fan speed < 430 rpm.
 - During nanoe™ X individual operation, fan speed follow remote control setting. Auto Fan Speed for nanoe™ X individual operation is cooling medium fan. Powerful & Quiet is disabled during nanoe™ X.
- Airflow direction control
 - During any operation mode combines with nanoe™ X operation, airflow direction follows respective operation mode.
 - During nanoe™ X individual operation, Air Swing follow remote control setting.
- Timer control
 - When ON Timer activates when unit stops, previous operation resumes and restored last saved nanoe™ X operation status.
 - When ON Timer activates during any operation, no change on current operation.
 - When OFF Timer activates during any operation, all operation stops and the latest nanoe™ X operation status is saved.
- Indicator
 - When nanoe™ X starts, nanoe™ X indicator ON.
- Remote control receiving sound
 - Normal Operation → nanoe™ X Operation : Beep
 - nanoe™ X Operation → Normal Operation : Beep
 - Stop → nanoe™ X individual Operation : Beep
 - nanoe™ X individual Operation → Stop : Long Beep
- Power failure
 - During nanoe™ X individual operation, if power failure occurs, after power resumes, nanoe™ X individual operation resumes immediately.
 - During combination operation, if power failure occurs, after power resumes, combination operation resume immediately.

- nanoe™ X check mode
 - To enable nanoe™ X check mode, during nanoe™ X operation ON:

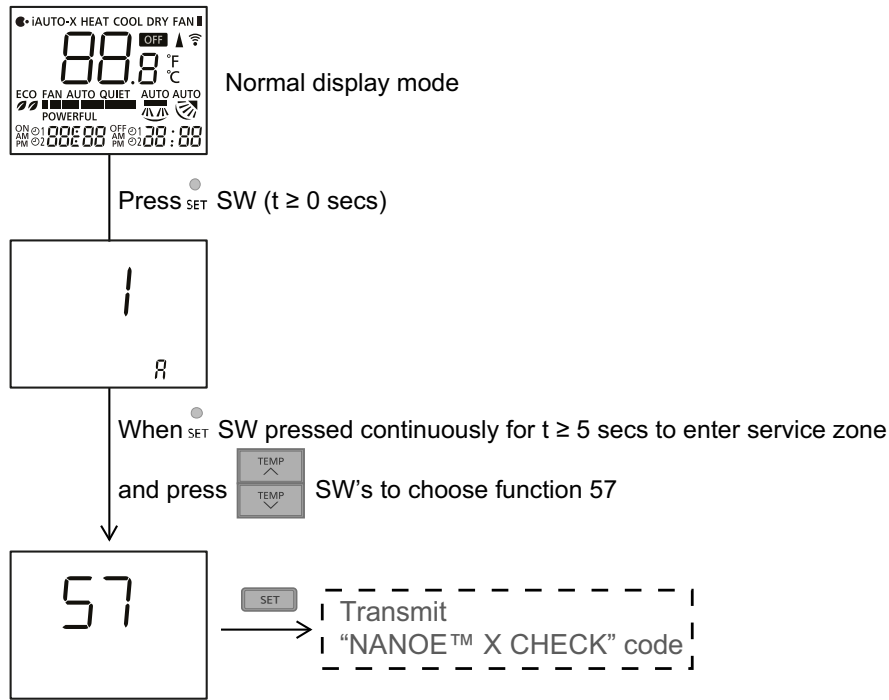

- During nanoe™ X check mode, H67 is judged when disconnection detected. Timer LED blinks.
- nanoe™ X Abnormal Detection
 - Disconnection Abnormality
 - Abnormal detection condition
 - Start from 1 sec after nanoe™ X power ON, 6 secs has passed and in this 6 secs period, abnormal signal is detected continuously for 5.9 secs.
 - Action after abnormal detection condition fulfilled
 - Disconnection counters +1, nanoe™ X power OFF for 5 minutes and then restart. However, according to action mode and disconnection counter, below will be implemented:
 - During nanoe™ X Check Mode: Disconnection abnormality will judged when disconnection counter ≥ 1. Abnormal code: H67 will memorized in EEPROM, Timer LED blinking and nanoe™ X LED Off.
 - Other Than Above: Disconnection abnormality will judged when disconnection counter ≥ 3. Abnormal code: H67 will memorized in EEPROM and nanoe™ X LED OFF, Timer LED not blinking.
 - Disconnection counters clear condition >
 - Disconnection counter will be cleared when operation stop. (Not nanoe™ X Check Mode)
 - nanoe™ X Discharge Abnormality
 - Abnormal detection condition
 - After 30 minutes nanoe™ X power ON, abnormal signal is being detected continuously for 5s.
 - Action after abnormal detection condition fulfilled
 - Abnormal discharge counter +1, nanoe™ X power OFF for 30 minutes and then restart. When abnormal discharge counter ≥ 12, abnormal code: H67 in analyze area (Area where abnormal code not displayed) will be memorized.
 - Abnormal discharge counters clear condition
 - Discharge counter will be cleared when operation become normal for 50 mins above or when operations stop.

14.14 Wireless LAN Control

14.14.1 System Overview.

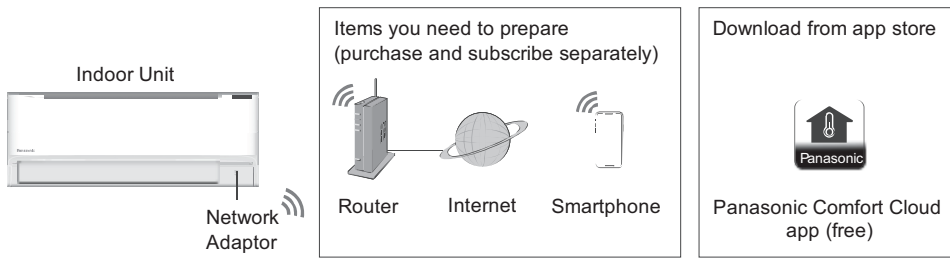

- This feature requires the app to work with a smartphone with Android 5.0 and above, or with iOS 9 and above. However, there is no guarantee that the app will work well with all versions.
- The Network Adaptor is designed specifically as a terminal for “Panasonic Comfort Cloud” app.
- The Wireless LAN network coverage must reach the indoor unit installation location.

Specification

Network Adaptor	Wireless LAN Module (built-in)
Model	DNSK-P11
Input Voltage	DC 5V (From Air Conditioner Indoor Unit)
Current Consumption	Tx/Rx max. 290/100 mA
Wireless LAN standard	IEEE 802.11 b/g/n
Frequency range	2.4 GHz band
Encryption	WPA2-PSK (TKIP/AES)

Precaution

- Do NOT disassemble or alter this Network Adaptor in any way.
- Do NOT remove this Network Adaptor from the indoor unit during operations.
- Data transmitted and received over radio waves may be intercepted and monitored.

Maximum radio-frequency power transmitted in the frequency bands

Type of wireless	Frequency band	Max. EIRP (dBm)
WLAN	2412 - 2472 MHz	20 dBm

Usage precautions

- Before using the product, be sure to read all the precautions in this manual. The Company is not liable for any defects and damages incurred by the use of this product that occur through incorrect use by yourself or a third party, unless legal liability is recognized in regard to failures.

Security Measure



- Wireless LAN uses radio waves to exchange information. Therefore, there is a risk of unauthorized access.
- Initialize the app settings on the product prior to disposal or transferring to a third party.

Before setting the network connection

- Confirm the wireless router is connected to the network correctly.
- Confirm the Wireless LAN of the smartphone is activated.
- Confirm your smartphone and this product are connected to the same wireless router.

14.14.2 Connecting Network



Before attempting to connect to the network, ensure the modem or wireless router is working and properly connected to allow internet access.

- Press  at the remote control to communicate with the home wireless LAN access point.
- Wireless LAN LED  from the indoor unit blinks to indicate the connection status to home access point.

Fast blink	The unit is establishing the connection.
Slow blink	The unit is not securing the connection.
No blink (stays on)	The unit has established the connection.

- It can establish the connection to the unit even if the unit is turned OFF.

14.14.3 App Installation

<p>For Android user (Android 5.0 and above)</p> <ul style="list-style-type: none"> • Open  • Search for "Panasonic Comfort Cloud" app. • Download and install. 	<p>For iOS user (iOS 9 and above)</p> <ul style="list-style-type: none"> • Open  • Search for "Panasonic Comfort Cloud" app. • Download and install.
--	--

Note

- The app user interface may change without notice when there is a version upgrade.
- There is no charge to use this app. However, other charges may be incurred for network connection and operation.

14.14.4 To Disconnect Wireless LAN (Off Wireless LAN LED)

- Press and release one time at the Remote Control Wireless LAN button and the LED will turn off. (LED ON -> LED OFF).

14.14.5 To Delete Wireless LAN Information

- If Wireless LAN is off (LED is Off), turn on Wireless LAN first by press and release one time the Wireless LAN button. (LED OFF -> LED ON).
- Push Wireless LAN button for 5 seconds.
- In the Remote Control Operation select "5" and push for 3 seconds.
- Initialization is finish and Wireless LAN LED will off automatically.

14.14.6 To Check Wireless LAN Signal Strength

- Confirm the air conditioner operation is stopped and press the Wireless LAN button for 5 seconds.
- Select "4" in the remote then press set button and operation stops.
- After 5 seconds, the signal strength is shown on the indoor unit Wireless LAN LED.
 - Strong Signal: Blink 3 times with an interval.
 - Moderate Signal: Blink 2 times with an interval.
 - Weak Signal: Blink once with an interval.
 - No Signal: OFF.
- It will stop automatically after 10 minutes. To stop immediately, press Wireless LAN button.

14.14.7 Wireless LAN Failure Diagnosis

14.14.7.1 Between ID Micon and Wireless LAN Module Failure Detect Condition

- When module and ID micon (CN-LAN) communication is following below condition.
 - No response against sending data.
 - Reply error against sending data.
 - Regularly sending from AC unit (Every 1 minutes).
- Either one from above condition occur, detection will start.
- If for certain time there is no communication and retry is implemented 3 times continuously confirm the error by following below table.
- When failure diagnosis H85 occur.

	Wireless LAN LED	Timer LED
When error condition check	Light up	No light
When retry	Light up	No light
After confirm failure	No light	Blinking

- Cancel Condition: From the module the reply data or the regularly sending data (normal data) is recognized by ID micon.

	Wireless LAN LED	Timer LED
When failure canceled	Light up	No light

- Failure communication parameter setting.

H85 communication error: time/retry counter	10 min/3 count
Wireless LAN disconnection judgment time	300 sec

14.14.8 Between ID AC and Broadband Router Failure Detect Condition

- Detect condition: Communication with router is interrupted.
- Confirm condition: The interrupted condition continue more than 5 minutes and retry is implemented.
- After confirm the failure operation: Not H85 error display and Wireless LAN LED is blinking.
- Cancel condition: Communication is return between Wireless LAN router.
- After cancel, return to normal operation and Wireless LAN LED is light up.

15. Protection Control

15.1 Protection Control for All Operations

15.1.1 Restart Control (Time Delay Safety Control)

- The Compressor will not turn on within 3 minutes from the moment operation stops, although the unit is turned on again by pressing OFF/ON button at remote control within this period.
- This control is not applicable if the power supply is cut off and on again.
- This phenomenon is to balance the pressure inside the refrigerant cycle.

15.1.2 Total Running Current Control

1. When the outdoor unit total running current (AC) exceeds X value, the frequency instructed for compressor operation will be decreased.
2. If the running current does not exceed X value for 5 seconds, the frequency instructed will be increased.
3. However, if total outdoor unit running current exceeds Y value, compressor will be stopped immediately for 3 minutes.

Model	HZ25XKE, HZ25XKE-5		HZ35XKE	
	X (A)	Y (A)	X (A)	Y (A)
Operation Mode				
Cooling / Soft Dry (A)	3.98	14.66	5.61	14.66
Cooling / Soft Dry (B)	3.53		5.16	
Heating	8.60		9.14	

4. The first 30 minutes of cooling operation, (A) will be applied.

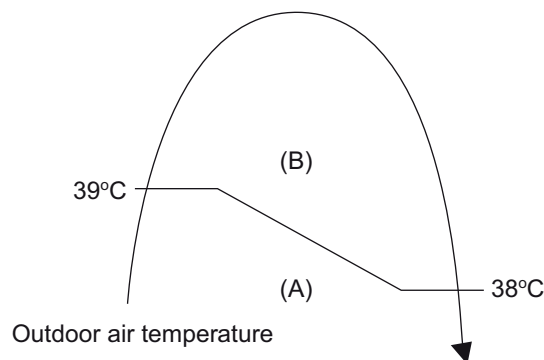

15.1.3 IPM (Power Transistor) Prevention Control

A. Overheating Prevention Control

1. When the IPM temperature rises to 120°C, compressor operation will stop immediately.
2. Compressor operation restarts after 3 minutes the temperature decreases to 110°C.
3. If this condition repeats continuously 4 times within 20 minutes, timer LED will be blinking ("F96" is indicated).

B. DC Peak Current Control

1. When electric current to IPM exceeds set value, the compressor will stop operate.
2. If the set value is exceeded again more than 30 seconds after the compressor starts, the operation will restart after 3 minutes.
3. If the set value exceeded again within 30 seconds after the compressor starts, the operation will restart after 2 minutes. If this condition repeats continuously for 7 times, all indoor and outdoor relays will be cut off, timer LED will be blinking ("F99" is indicated).

15.1.4 Compressor Overheating Prevention Control

- Instructed frequency for compressor operation will be regulated by compressor discharge temperature. The changes of frequency are as below.
- If compressor discharge temperature exceeds 103°C, compressor will be stopped, occurs 4 times per 20 minutes, timer LED will be blinking. ("F97" is indicated.)

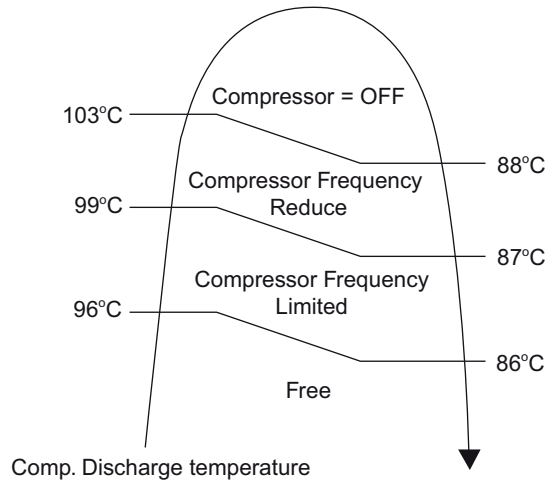

15.1.5 Low Pressure Prevention Control (Gas Leakage Detection)

a. Control start conditions

- For 5 minutes, the compressor continuously operates and outdoor total current is between 0.36A and 0.54A.
- During Cooling and Soft Dry operations:
Indoor suction temperature - indoor piping temperature is below 4°C.
- During Heating operations :
Indoor piping temperature - indoor suction is under 5°C.

b. Control contents

- Compressor stops (and restart after 3 minutes).
- If the conditions above happen 2 times within 20 minutes, the unit will:
 - Stop operation
 - Timer LED blinks and "F91" indicated.

15.1.6 Low Frequency Protection Control 1

- When the compressor operate at frequency lower than 24 Hz continued for 240 minutes, the operation frequency will be changed to 23 Hz for 2 minutes.

15.1.7 Low Frequency Protection Control 2

- When all the below conditions comply, the compressor frequency will change to lower frequency.

Temperature, T, for:	Cooling / Soft Dry	Heating
Indoor intake air (°C)	T < 14 or T ≥ 30	T < 14 or T ≥ 28
Outdoor air (°C)	T < 13 or T ≥ 38	T < 4 or T ≥ 24
Indoor heat exchanger (°C)	T < 30	T ≥ 0

15.2 Protection Control for Cooling & Soft Dry Operation

15.2.1 Outdoor Air Temperature Control

- The compressor operating frequency is regulated in accordance to the outdoor air temperature as shown in the diagram below.
- This control will begin 1 minute after the compressor starts.
- Compressor frequency will adjust base on outdoor air temperature.

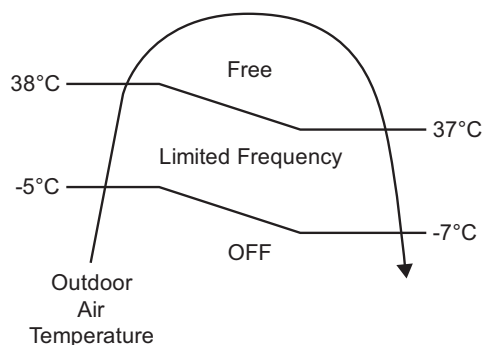

15.2.2 Cooling Overload Control

- Detects the Outdoor pipe temperature and carry out below restriction/limitation (Limit the compressor Operation frequency)
- The compressor stop if outdoor pipe temperature exceeds 60°C.
- If the compressor stops 4 times in 20 minutes, Timer LED blinking (F95 indicated: outdoor high pressure rise protection)

15.2.3 Freeze Prevention Control 1

1. When indoor heat exchanger temperature is lower than 0°C continuously for 6 minutes, compressor will stop operating.
2. Compressor will resume its operation 3 minutes after the indoor heat exchanger is higher than 5°C.
3. At the same time, indoor fan speed will be higher than during its normal operation.
4. If indoor heat exchanger temperature is higher than 13°C for 5 minutes, the fan speed will return to its normal operation.

15.2.4 Freeze Prevention Control 2

1. Control start conditions
 - During Cooling operation and soft dry operation
 - During thermo OFF condition, indoor intake temperature is less than 10°C or
 - Compressor stops for freeze prevention control
 - Either one of the conditions above occurs 5 times in 60 minutes.
2. Control contents
 - Operation stops
 - Timer LED blinks and "H99" indicated

15.2.5 Dew Prevention Control 1

- To prevent dew formation at indoor unit discharge area.
- This control will be activated if:
 - Outdoor air temperature and Indoor pipe temperature judgment by microcontroller is fulfilled.
 - When Cooling or Dry mode is operated more than 20 minutes or more.
- This control stopped if:
 - Compressor stopped.
 - Remote control setting changed (fan speed / temperature).
 - Outdoor air temperature and indoor intake temperature changed.
- Fan speed will be adjusted accordingly in this control.

15.2.6 Odor Cut Control

- To reduce the odor released from the unit.
 - Start Condition
 - AUTO FAN Speed is selected during COOL or DRY operation.
 - During freeze prevention control and timer preliminary operation, this control is not applicable.
 - Control content
 - Depends on compressor conditions:
 - Compressor OFF → Compressor ON.
The indoor unit fan stops temporarily and then starts to blow at minimum airflow for 30 seconds.
 - Compressor ON → Compressor OFF.
The indoor unit fan stops for 90 seconds and then blows at minimum airflow for 20 seconds.

15.3 Protection Control for Heating Operation

15.3.1 Intake Air Temperature Control

Compressor will operate at limited freq., if indoor intake air temperature is 30°C or above.

15.3.2 Outdoor Air Temperature Control

- The Max current value is regulated when the outdoor air temperature rise above 14°C in order to avoid compressor overloading.

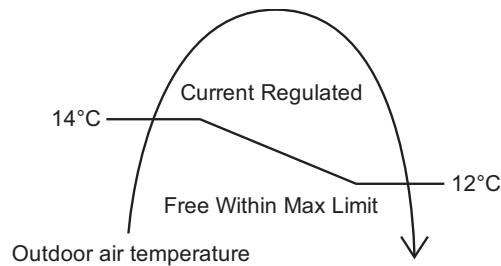

15.3.3 Overload Protection Control

- The compressor operating frequency is regulated in accordance to indoor heat exchanger temperature as shown below.
- If the heat exchanger temperature exceeds 60°C, compressor will stop.

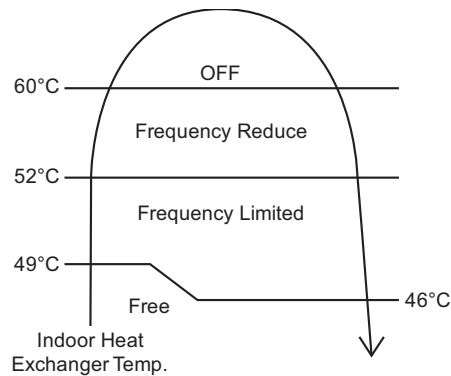

15.3.4 Compressor Oil Return Control

- When compressor starts, the compressor will be regulated for 240 seconds.

15.3.5 Cold Draught Prevention Control

- When indoor pipe temperature is low, cold draught operation starts where indoor fan speed will be reduced.

15.3.6 Deice Operation

- When outdoor pipe temperature and outdoor air temperature is low, deice operation start where indoor fan motor and outdoor fan motor stop and the Deice LED ON.

16. Servicing Mode

16.1 Auto OFF/ON Button

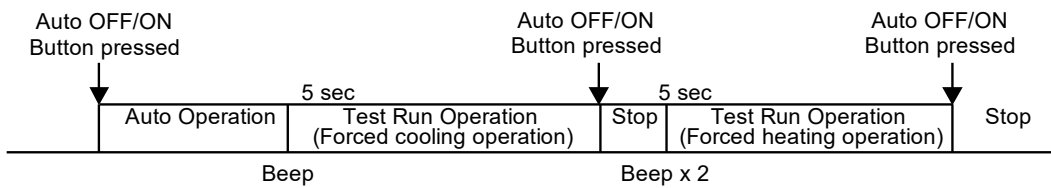

1 AUTO OPERATION MODE

The Auto operation will be activated immediately once the Auto OFF/ON button is pressed. This operation can be used to operate air conditioner with limited function if remote control is misplaced or malfunction.

2 TEST RUN OPERATION (FOR PUMP DOWN/SERVICING PURPOSE)

The Test Run operation will be activated if the Auto OFF/ON button is pressed continuously for more than 5 seconds. A “beep” sound will heard at the fifth seconds, in order to identify the starting of Test Run operation (Forced cooling operation). Within 5 minutes after Forced cooling operation start, the Auto OFF/ON button is pressed for more than 5 seconds. A 2 “beep” sounds will heard at the fifth seconds, in order to identify the starting of Forced heating operation.

The Auto OFF/ON button may be used together with remote control to set / change the advance setting of air conditioner operation.

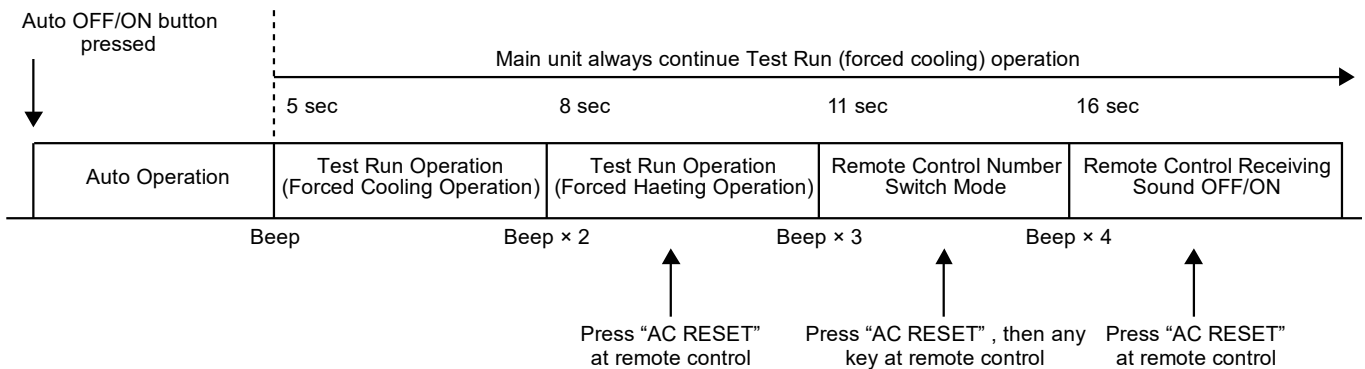

3 REMOTE CONTROL NUMBER SWITCH MODE

The Remote Control Number Switch Mode will be activated if the Auto OFF/ON button is pressed continuously for more than 11 seconds (3 “beep” sounds will occur at 11th seconds to identify the Remote Control Number Switch Mode is in standby condition) and press “AC RESET” button and then press any button at remote control to transmit and store the desired transmission code to the EEPROM.

There are 4 types of remote control transmission code could be selected and stored in EEPROM of indoor unit. The indoor unit will only operate when received signal with same transmission code from remote control. This could prevent signal interference when there are 2 or more indoor units installed nearby together. To change remote control transmission code, short or open jumpers at the remote control printed circuit board.

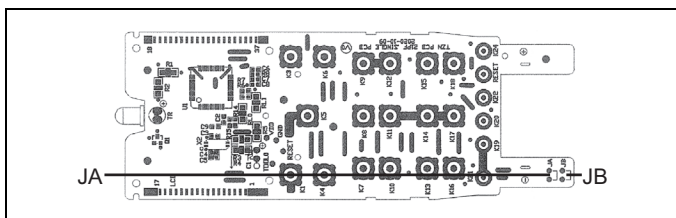

Remote Control Printed Circuit Board		
Jumper A (J-A)	Jumper B (J-B)	Remote Control No.
Short	Open	A (Default)
Open	Open	B
Short	Short	C
Open	Short	D

- During Remote Control Number Switch Mode, press any button at remote control to transmit and store the transmission code to the EEPROM.

4 REMOTE CONTROL RECEIVING SOUND OFF/ON MODE

The Remote Control Receiving Sound OFF/ON Mode will be activated if the Auto OFF/ON button is pressed continuously for more than 16 seconds (4 “beep” sounds will occur at 16th seconds to identify the Remote Control Receiving Sound Off/On Mode is in standby condition) and press “AC Reset” button at remote control.





Press “Auto OFF/ON button” to toggle remote control receiving sound.

- Short “beep”: Turn OFF remote control receiving sound.
- Long “beep”: Turn ON remote control receiving sound.

After Auto OFF/ON Button is pressed, the 20 seconds counter for Remote Control Receiving Sound OFF/ON Mode is restarted.

16.2 Heat Only Operation

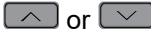
16.2.1 How to Activate/Deactivate Heat only Operation

- Use remote controller to set heating only operation. When the unit in standby mode, follow the steps below:
 - a) Press  continuously for more than 5 seconds to enter special setting mode.
 - b) Press  to choose function 61, and then press  to set “01”. (To enable the “Heat Only” mode) or “00” (To disable the “Heat Only” mode).
 - c) Press  to activate “Heating only operation” or deactivate “Heating only operation”.

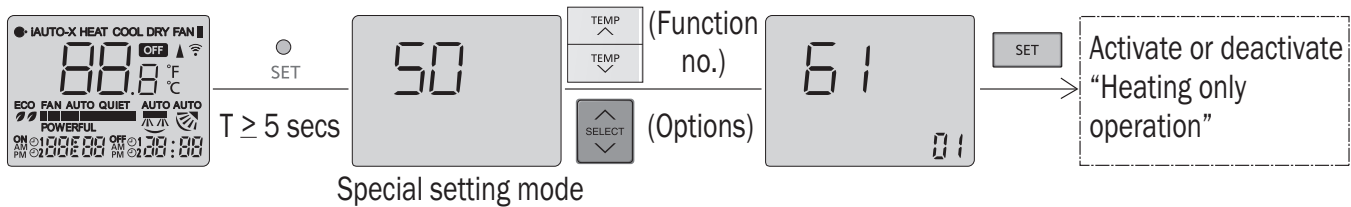

16.2.2 Operation Mode During Heating Only Operation

- The table below shows the operation mode comparison when Heating Only Operation Mode Activated and Deactivated.

Operation Mode	Heating Only Operation Mode Activated	Heating Only Operation Mode Deactivated
AUTO	After 30s sampling, regardless of the indoor intake or outdoor intake temperature judgment, the unit will run Heating operation.	After 30s sampling, the unit will judge the operation mode base on remote controller temperature setting and Indoor Intake Sensor (New Auto Mode) or Outdoor Intake Sensor (Old Auto Mode).
HEAT	The unit will run Heating operation.	The unit will run Heating operation.
COOL	The unit will stop and Power LED blinking.	The unit will run Cooling operation.
DRY	The unit will stop and Power LED blinking.	The unit will run Cooling Dry operation.
NANOE Stand-alone	The unit will stop and Power LED blinking.	The unit will run Nanoe Stand-alone operation.
Force Cooling	The unit will run Force Cooling Operation for X_CTRYTM [15] minutes	The unit will run Force Cooling operation.
Force Heating	The unit will run Force Heating operation.	The unit will run Force Heating operation.
AUTO (with Timer)	The unit will turn ON by the timer and run Auto Operation. After 30s sampling, regardless of the indoor intake or outdoor intake temperature judgment, the unit will run Heating operation.	The unit will turn ON by the timer and run Auto Operation. After 30s sampling, the unit will judge the operation mode base on remote controller temperature setting and Indoor Intake Sensor (New Auto Mode) or Outdoor Intake Sensor (Old Auto Mode).
HEAT (with Timer)	The unit will turn ON by the timer and run Heating Operation.	The unit will turn ON by the timer and run Heating Operation.
COOL (with Timer)	The unit will not turn ON by the timer. Power LED blinking.	The unit will turn ON by the timer and run Cooling Operation.
DRY (with Timer)	The unit will not turn ON by the timer. Power LED blinking.	The unit will turn ON by the timer and run Cooling Dry Operation.
Cooling Test Mode	The unit will stop and Power LED blinking.	The unit will operate according to specify Cooling test mode operation parameter.
Heating Test Mode	The unit will operate according to specify Heating test mode operation parameter.	The unit will operate according to specify Heating test mode operation parameter.



16.3 Remote Control Button

16.3.1 SET Button

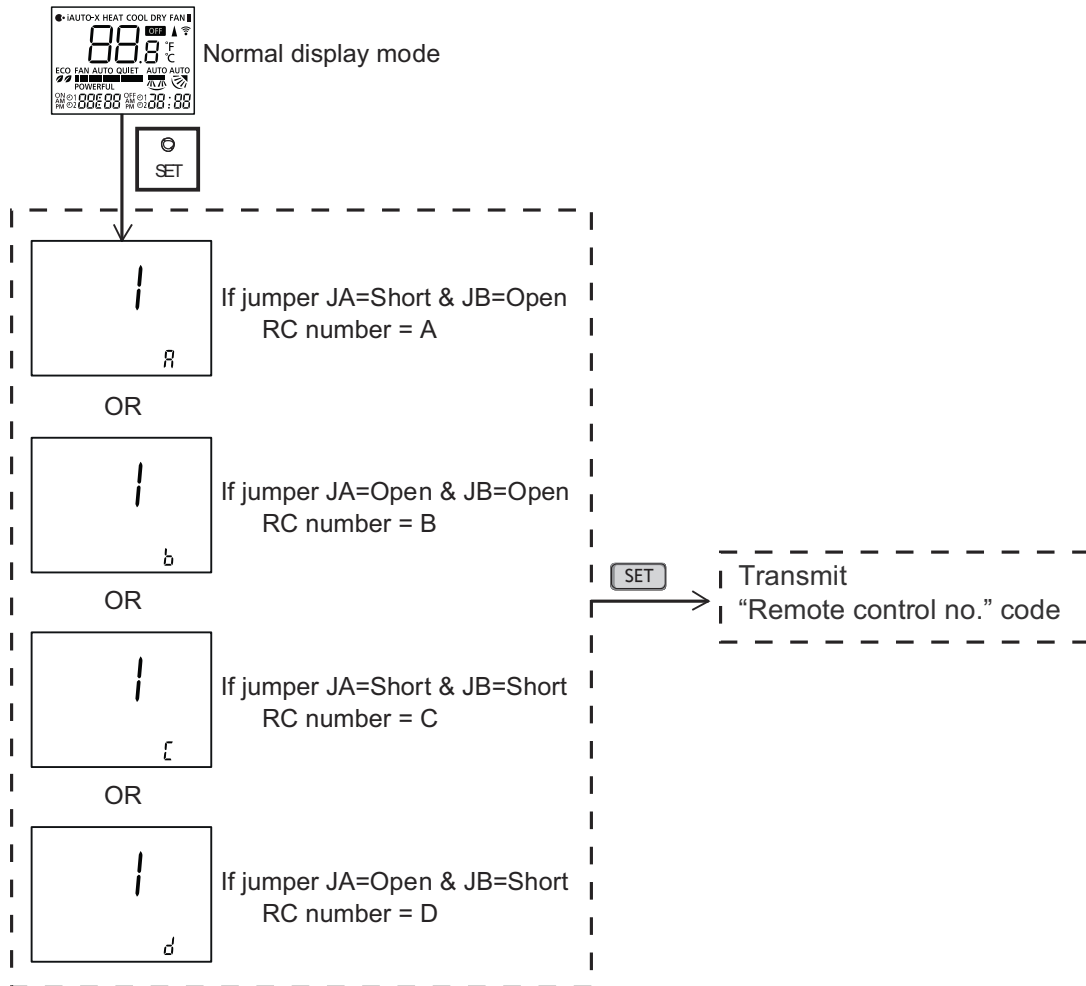
- To check remote control transmission code and store the transmission code to EEPROM.
 - Press "Set" button by using pointer.
 - Press "Timer Set" button until a "beep" sound is heard as confirmation of transmission code change.
 - LCD returns to original display if remote control does not operate for 30 seconds.



- Press **CANCEL** SW, special setting is immediately cancelled and normal mode starts.
- If no SW is pressed for 30 secs, then special setting mode is cancelled and normal mode starts.

- Under this function, only **TEMP** , **TEMP** , **SET**, **CANCEL** and **RC**  SW's are effective.

- To limit set temperature range for COOL & DRY, HEAT, AUTO mode.
 - Press “Set” button by using pointer.
 - Press TEMP increment or decrement button to choose No. 3.
 - Press Timer increment or decrement button to select desired temperature low limit of set temperature for COOL & DRY mode.

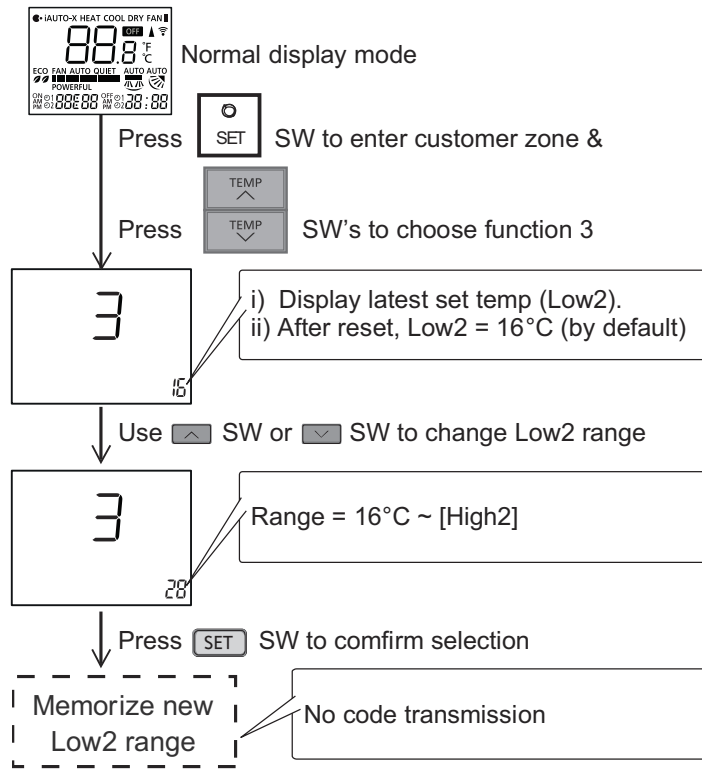

- Press Timer Set button to confirm low limit selection.
- Press TEMP increment or decrement button to choose No. 4.
- Press Timer decrement or increment button to select desired temperature high limit of set temperature for COOL & DRY mode.

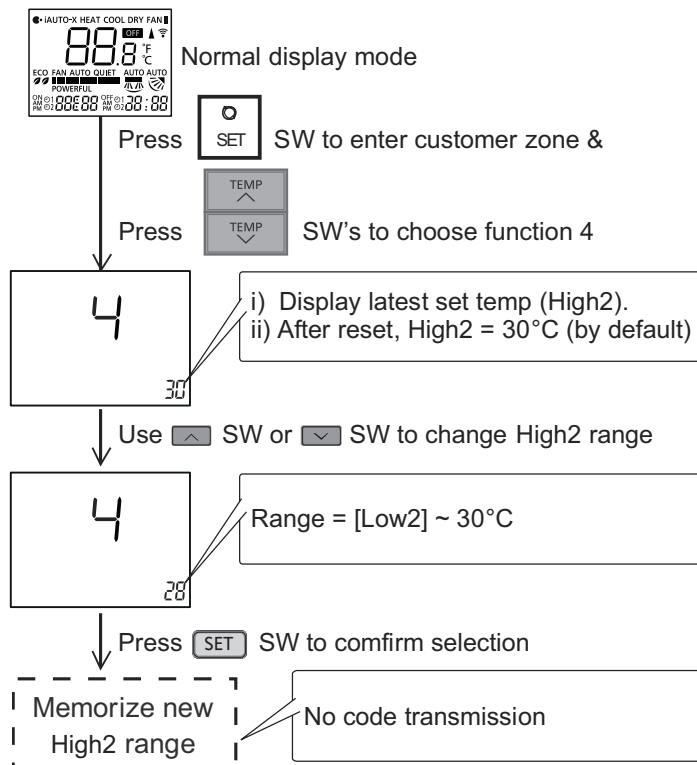

- Press Timer Set button to confirm high limit selection.

- Press TEMP increment or decrement button to choose No. 5.
- Press Timer increment or decrement button to select desired temperature low limit of set temperature for HEAT mode.

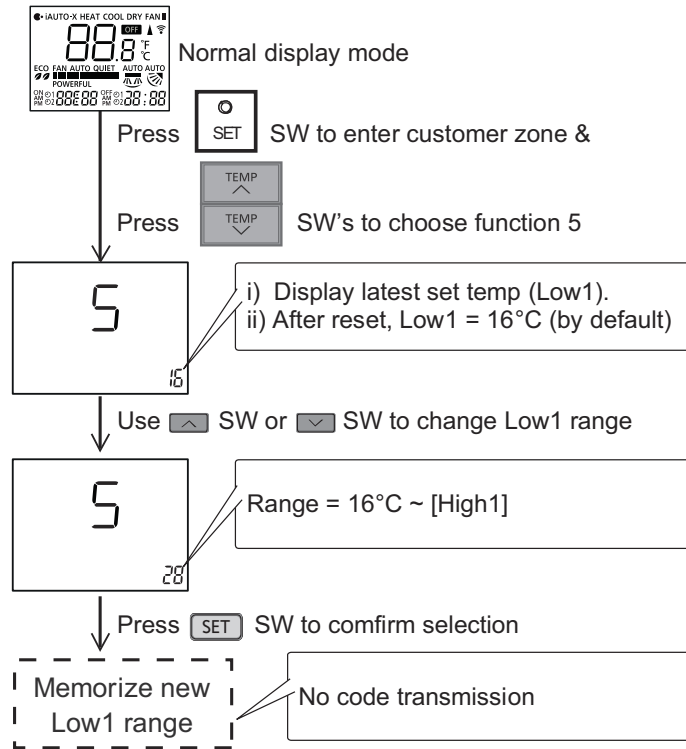

- Press Timer Set button to confirm low limit selection.
- Press TEMP increment or decrement button to choose No. 6.
- Press Timer decrement or increment button to select desired temperature high limit of set temperature for HEAT mode.

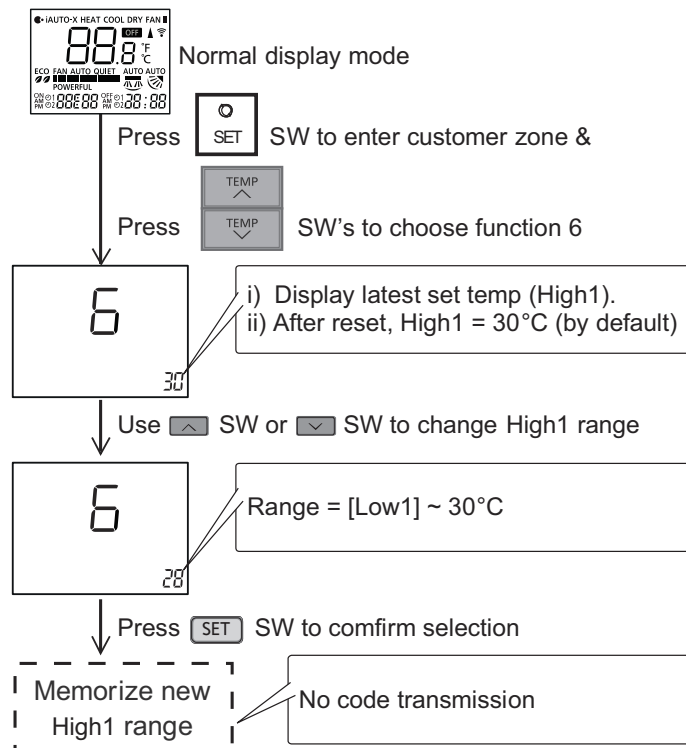

- Press Timer Set button to confirm high limit selection.

- Press TEMP increment or decrement button to choose No. 12.
- Press Timer increment or decrement button to select desired temperature low limit of set temperature for AUTO mode.

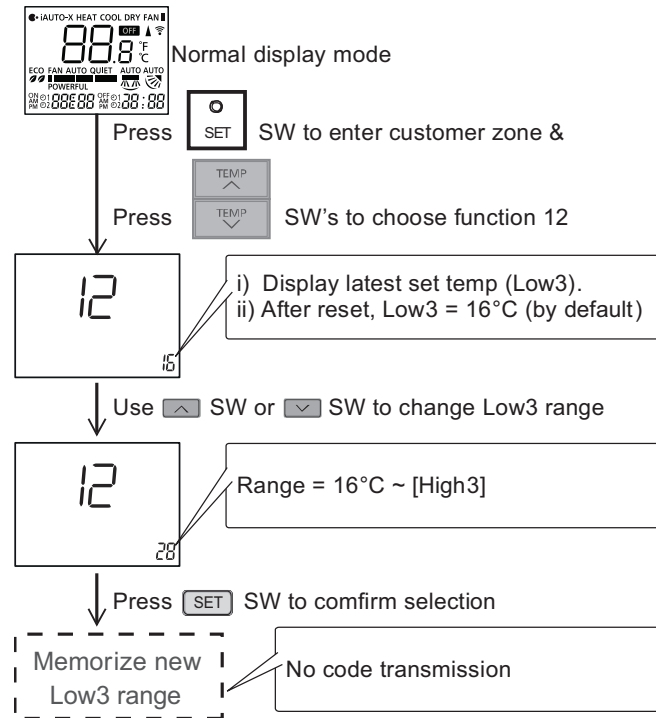

- Press Timer Set button to confirm low limit selection.
- Press TEMP increment or decrement button to choose No. 13.
- Press Timer decrement or increment button to select desired temperature high limit of set temperature for AUTO mode.

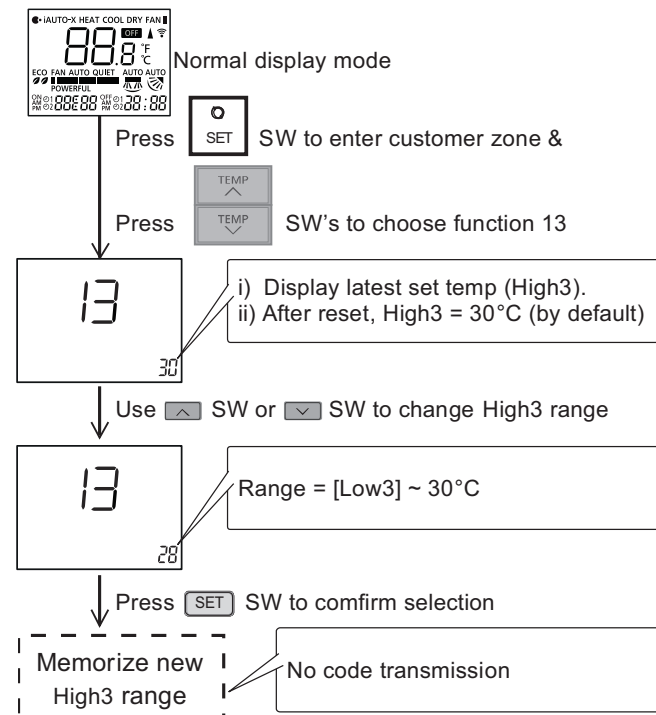

- Press Timer Set button to confirm high limit selection.
- LCD returns to original display if remote control does not operate for 30 seconds or press Timer Cancel button.

- Auto restart enable/disable selection

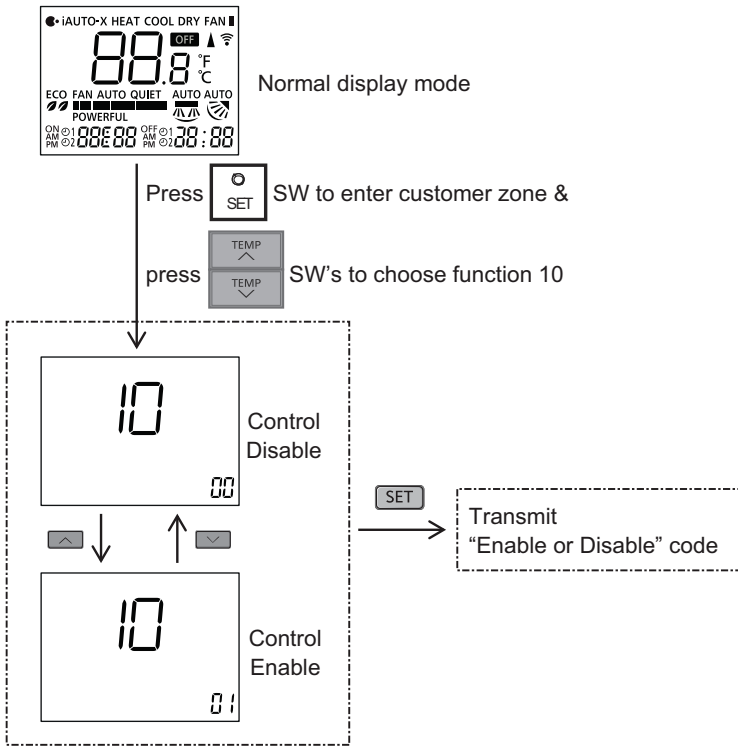

- ① Press **CANCEL** SW, special setting is immediately cancelled and normal mode starts.
- ② If no SW is pressed for 30secs, then special setting mode is cancelled and normal mode starts.

- ③ Under this function, only **TEMP** up/down, **↑**, **↓**, **SET**, **CANCEL** & **RC** **RESET** SW's are effective.

Note:
By default is enable.

- New Deice Judgement Selection

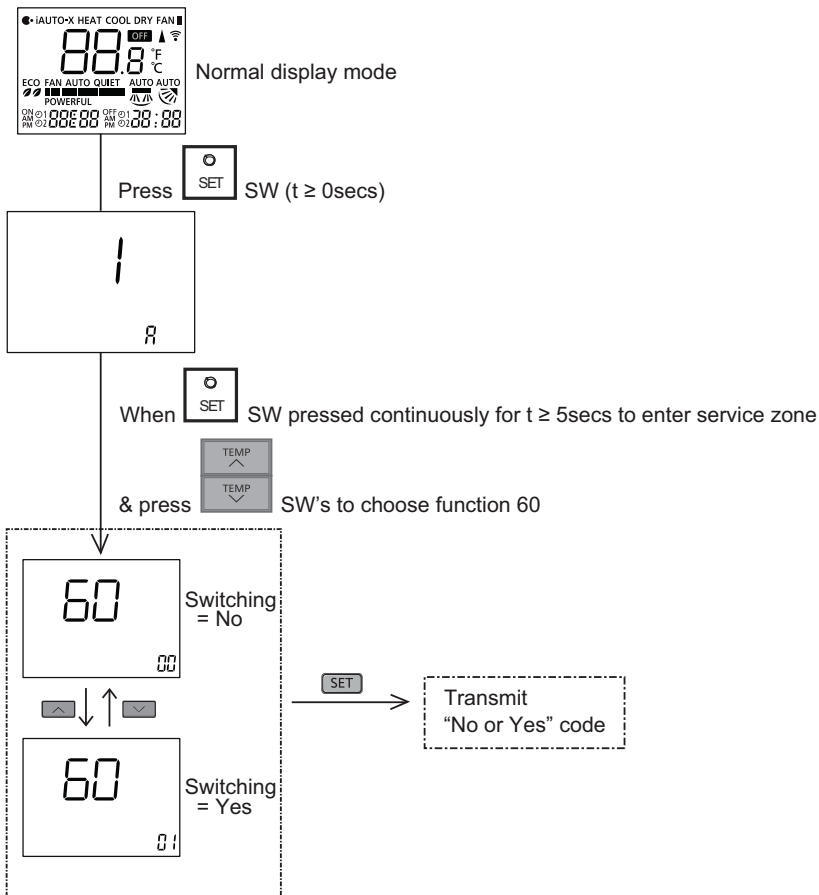

Note:
By default is New Deice Judgement.

16.3.2 RESET (RC)

- To clear and restore the remote control setting to factory default.
 - Press once to clear the memory

16.3.3 RESET (AC)

- To restore the unit's setting to factory default.
 - Press once to restore the unit's setting.

16.3.4 TIMER

- To change indoor unit indicators' intensity:
 - Press continuously for 5 seconds.

16.3.5 TIMER

- To change remote control display from Degree Celsius ($^{\circ}\text{C}$) to Degree Fahrenheit ($^{\circ}\text{F}$).
 - Press continuously for 10 seconds.

16.3.6 Customization mode

1 LCD display area:

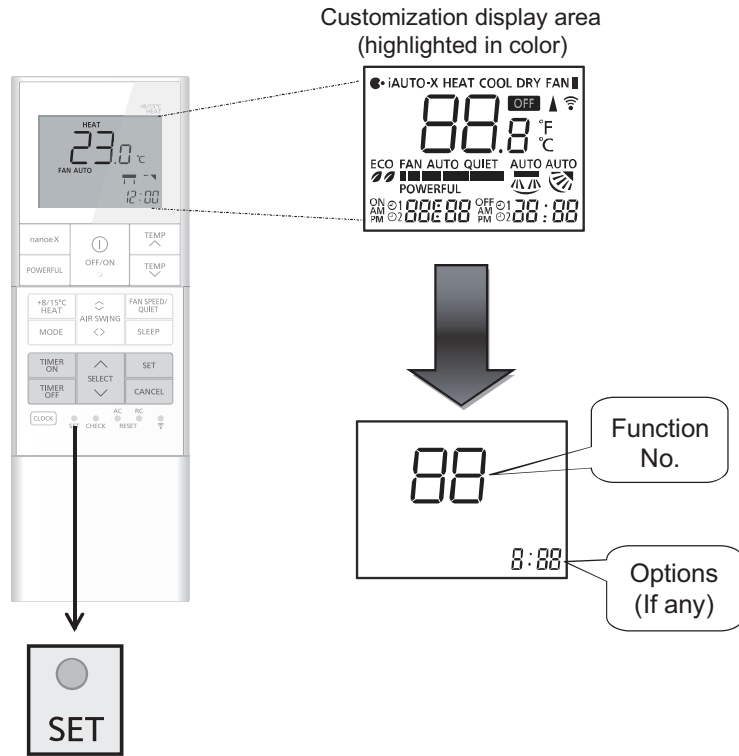

2 Cannot enter this customization mode under the following conditions:

- ① Operation ON.
- ② Under [Real/ON/OFF] time setting mode.

3 To enter Customer zone:

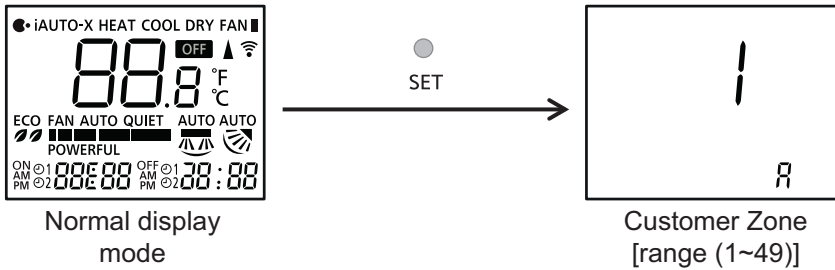

4 To enter Service zone: (Press SET continuously for T ≥ 5 secs)

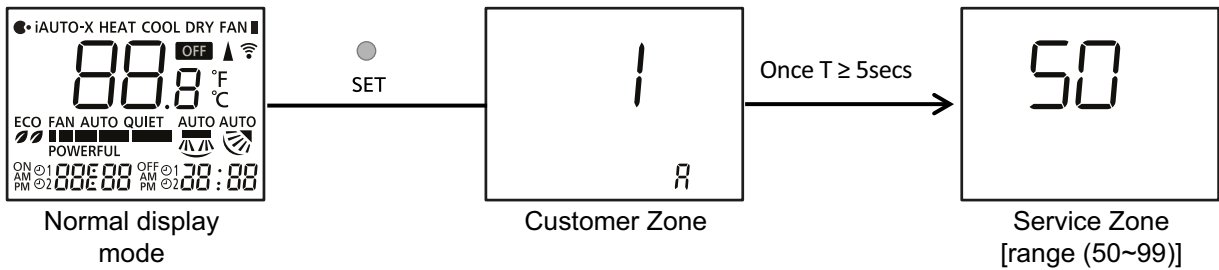

5 Function & Options list:

Note: The functions described in the table may not be applicable to the model and may subject to change without further notice.

		Customization		Options	Remark
No	Name				
Customer Zone	1	Remote control number selection		A, B, C, D	
	2	Solar radiation sensitivity level adjustment		1, 2, 3, 4, 5	
	3	[iAUTO-X/iAUTO/iCOMF, Cool & Dry] mode set temperature [Low2] selection		16°C ~ [High2]	
	4	[iAUTO-X/iAUTO/iCOMF, Cool & Dry] mode set temperature [High2] selection		[Low2] ~ 30°C	
	5	Heat mode set temperature Low1 selection		16°C ~ [High1]	
	6	Heat mode set temperature High1 selection		[Low1] ~ 30°C	
	7	Filter cleaning selection		00 – Disable 01 – Enable	
	8	nanoe/nanoe-G default ON selection		00 – Disable 01 – Enable	
	9	Dust sensor monitoring & LED selection		00 – Disable 01 – Enable	
	10	Auto restart selection		00 – Disable 01 – Enable	
	11	Dust sensor sensitivity level adjustment		1, 2, 3	
	12	Auto mode set temperature Low3 selection		16°C ~ [High3]	
	13	Auto mode set temperature High3 selection		[Low3] ~ 30°C	
	14	Indoor unit installation position selection		ct – Center lt – Left rt – Right	
	15	ECO status memorize selection		00 – Disable 01 – Enable	
16 ~ 49	Reserve				
Service Zone	50	ECO demo ON		None (No display)	
	51	Light sensor check		None (No display)	
	52	nanoe-G / ECO sensor check		None (No display)	
	53	DOA check		None (No display)	
	54	Odor cut control selection		00 – Disable 01 – Enable	
	55	Frequency tolerance selection		03 – ±3Hz 07 – ±7Hz	
	56	Fixed fan speed selection during heat mode compressor OFF		00 – Disable 01 – Enable	
	57	nanoe check		None (No display)	
	58	Heat mode thermo shift adjustment		-3°C ~ 3°C	
	59	Others (Cool & Dry) mode thermo shift adjustment		-3°C ~ 3°C	
	60	Deice start determination judgment temperature switching		00 – No 01 – Yes	
	61	Cool mode disable selection		00 – No 01 – Yes	
	62	Heat mode disable selection		00 – No 01 – Yes	
63	Base pan heater selection		A – Base pan A b – Base pan B		
64	Disable fan speed reduction during cool mode thermo-Off		00 – No 01 – Yes		
65	LED smart OFF selection		00 – Disable 01 – Enable		
66	nanoe-G ON/OFF duration selection		01 – Pattern 1 02 – Pattern 2 03 – Pattern 3 04 – Pattern 4		
67	Operation OFF deice function selection		00 – Disable 01 – Enable		

		Customization		Options	Remark
		No	Name		
Service Zone	68	Compressor frequency change speed selection		01 – Pattern 1 02 – Pattern 2 03 – Pattern 3	
	69	Up/Down air swing upper limit restriction selection		00 – Disable 01 – Enable	
	70	Failure diagnosis mode disable		None (No display)	
	71	Compressor Fhmax setting selection		01 – Offset 1 02 – Offset 2 03 – Offset 3	
	72	Compressor Max Fc setting selection		00 – Disable 01 – Enable	
	73 ~ 99	Reserve			

17. Troubleshooting Guide

17.1 Refrigeration Cycle System

In order to diagnose malfunctions, make sure that there are no electrical problems before inspecting the refrigeration cycle.

Such problems include insufficient insulation, problem with the power source, malfunction of a compressor and a fan.

The normal outlet air temperature and pressure of the refrigeration cycle depends on various conditions, the standard values for them are shown in the table on the right.

Normal Pressure and Outlet Air Temperature (Standard)

	Gas pressure MPa (kg/cm ² G)	Outlet air temperature (°C)
Cooling Mode	0.9 ~ 1.2 (9 ~ 12)	13 ~ 17
Heating Mode	2.0 ~ 2.7 (20 ~ 27)	32 ~ 42

- ★ Condition:
- Indoor fan speed; High
 - Outdoor temperature 35°C at cooling mode and 7°C at heating mode.
 - Compressor operates at rated frequency

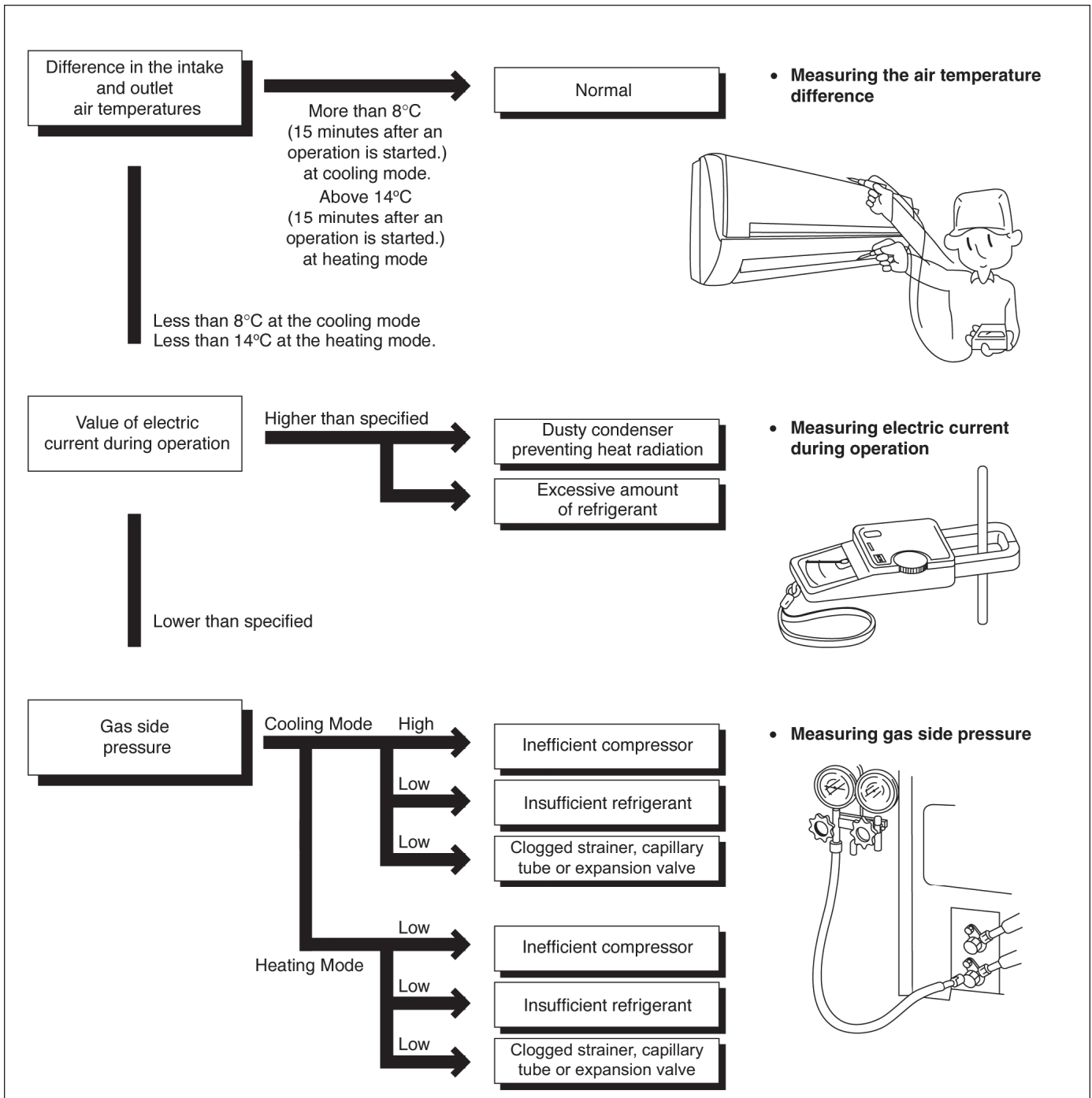

17.1.1 Relationship Between the Condition of the Air Conditioner and Pressure and Electric Current

Condition of the air conditioner	Cooling Mode			Heating Mode		
	Low Pressure	High Pressure	Electric current during operation	Low Pressure	High Pressure	Electric current during operation
Insufficient refrigerant (gas leakage)	↘	↘	↘	↘	↘	↘
Clogged strainer, capillary tube or expansion valve	↘	↘	↘	↗	↗	↗
Short circuit in the indoor unit	↘	↘	↘	↗	↗	↗
Heat radiation deficiency of the outdoor unit	↗	↗	↗	↘	↘	↘
Inefficient compression	↗	↘	↘	↗	↘	↘





- Carry out the measurements of pressure, electric current, and temperature fifteen minutes after an operation is started.

17.2 Breakdown Self Diagnosis Function

17.2.1 Self Diagnosis Function (Three Digits Alphanumeric Code)



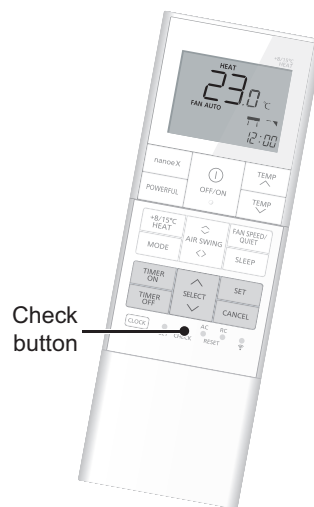

- Once abnormality has occurred during operation, the unit will stop its operation, and Timer LED blinks.
- Although Timer LED goes off when power supply is turned off, if the unit is operated under a breakdown condition, the LED will light up again.
- In operation after breakdown repair, the Timer LED will no more blink. The last error code (abnormality) will be stored in IC memory.

17.2.2 To Make a Diagnosis

- 1 Timer LED start to blink and the unit automatically stops the operation.
- 2 Press the CHECK button on the remote controller continuously for 5 seconds.
- 3 “- -” will be displayed on the remote controller display.
Note: Display only for “- -”. (No transmitting signal, no receiving sound and no Power LED blinking.)
- 4 Press the “TIMER”  or  button on the remote controller. The code “H00” (no abnormality) will be displayed and signal will be transmitted to the main unit.
- 5 Each press of the button ( or ) will increase error code number and transmit error code signal to the main unit.
- 6 When the latest abnormality code on the main unit and code transmitted from the remote controller are matched, power LED will light up for 30 seconds and a beep sound (continuously for 4 seconds) will be heard. If no codes are matched, power LED will light up for 0.5 seconds and no sound will be heard.
- 7 The breakdown diagnosis mode will be canceled unless pressing the CHECK button continuously for 5 seconds or operating the unit for 30 seconds.
- 8 The LED will be off if the unit is turned off or the RESET button on the main unit is pressed.



17.2.3 To Display Memorized Error (Protective Operation) Status

- 1 Turn power on.
- 2 Press the CHECK button on the remote controller continuously for 5 seconds
- 3 “- -” will be displayed on the remote controller display.
Note: Display only for “- -”. (No transmitting signal, no receiving sound and no Power LED blinking.)
- 4 Press the “TIMER”  or  button on the remote controller. The code “H00” (no abnormality) will be displayed and signal will be transmitted to the main unit. The power LED lights up. If no abnormality is stored in the memory, three beeps sound will be heard.
- 5 Each press of the button ( or ) will increase error code number and transmit error code signal to the main unit.
- 6 When the latest abnormality code on the main unit and code transmitted from the remote controller are matched, power LED will light up for 30 seconds and a beep sound (continuously for 4 seconds) will be heard. If no codes are matched, power LED will light up for 0.5 seconds and no sound will be heard.
- 7 The breakdown diagnosis mode will be canceled unless pressing the CHECK button continuously for 5 seconds or operating the unit for 30 seconds.
- 8 The same diagnosis can be repeated by turning power on again.

17.2.4 To Clear Memorized Error (Protective Operation) Status after Repair:

- 1 Turn power on (in standby condition).
- 2 Press the AUTO button for 5 seconds (A beep receiving sound) on the main unit to operate the unit at Forced Cooling Operation modes.
- 3 Press the CHECK button on the remote controller for about 1 second with a pointed object to transmit signal to main unit. A beep sound is heard from main unit and the data is cleared.

17.2.5 Temporary Operation (Depending On Breakdown Status)

- 1 Press the AUTO button (A beep receiving sound) on the main unit to operate the unit. (Remote control will become possible.)
- 2 The unit can temporarily be used until repaired.

17.3 Error Code Table

Diagnosis display	Abnormality / Protection control	Abnormality Judgment	Protection Operation	Problem	Check location
H00	No memory of failure	—	Normal operation	—	—
H11	Indoor/outdoor abnormal communication	After operation for 1 minute	Indoor fan only operation can start by entering into force cooling operation	Indoor/outdoor communication not establish	<ul style="list-style-type: none"> Indoor/outdoor wire terminal Indoor/outdoor PCB Indoor/outdoor connection wire
H12	Indoor unit capacity unmatched	90s after power supply	—	Total indoor capability more than maximum limit or less than minimum limit, or number of indoor unit less than two	<ul style="list-style-type: none"> Indoor/outdoor connection wire Indoor/outdoor PCB Specification and combination table in catalogue
H14	Indoor intake air temperature sensor abnormality	Continuous for 5s	—	Indoor intake air temperature sensor open or short circuit	<ul style="list-style-type: none"> Indoor intake air temperature sensor lead wire and connector
H15	Compressor temperature sensor abnormality	Continuous for 5s	—	Compressor temperature sensor open or short circuit	<ul style="list-style-type: none"> Compressor temperature sensor lead wire and connector
H16	Outdoor current transformer (CT) abnormality	—	—	Current transformer faulty or compressor faulty	<ul style="list-style-type: none"> Outdoor PCB faulty or compressor faulty
H19	Indoor fan motor mechanism lock	Continuous happen for 7 times	—	Indoor fan motor lock or feedback abnormal	<ul style="list-style-type: none"> Fan motor lead wire and connector Fan motor lock or block
H23	Indoor heat exchanger temperature sensor abnormality	Continuous for 5s	—	Indoor heat exchanger temperature sensor open or short circuit	<ul style="list-style-type: none"> Indoor heat exchanger temperature sensor lead wire and connector
H24	Indoor heat exchanger temperature sensor 2 abnormality	Continuous for 5s	—	Indoor heat exchanger temperature sensor 2 open or short circuit	<ul style="list-style-type: none"> Indoor heat exchanger temperature sensor 2 lead wire and connector
H25	Indoor ion device abnormality	Port is ON for 10s during ion device off	—	—	<ul style="list-style-type: none"> ion device PCB
H27	Outdoor air temperature sensor abnormality	Continuous for 5s	—	Outdoor air temperature sensor open or short circuit	<ul style="list-style-type: none"> Outdoor air temperature sensor lead wire and connector
H28	Outdoor heat exchanger temperature sensor 1 abnormality	Continuous for 5s	—	Outdoor heat exchanger temperature sensor 1 open or short circuit	<ul style="list-style-type: none"> Outdoor heat exchanger temperature sensor 1 lead wire and connector
H30	Outdoor discharge pipe temperature sensor abnormality	Continuous for 5s	—	Outdoor discharge pipe temperature sensor open or short circuit	<ul style="list-style-type: none"> Outdoor discharge pipe temperature sensor lead wire and connector
H32	Outdoor heat exchanger temperature sensor 2 abnormality	Continuous for 5s	—	Outdoor heat exchanger temperature sensor 2 open or short circuit	<ul style="list-style-type: none"> Outdoor heat exchanger temperature sensor 2 lead wire and connector
H33	Indoor / outdoor misconnection abnormality	—	—	Indoor and outdoor rated voltage different	<ul style="list-style-type: none"> Indoor and outdoor units check
H34	Outdoor heat sink temperature sensor abnormality	Continuous for 2s	—	Outdoor heat sink temperature sensor open or short circuit	<ul style="list-style-type: none"> Outdoor heat sink sensor
H36	Outdoor gas pipe temperature sensor abnormality	Continuous for 5s	Heating protection operation only	Outdoor gas pipe temperature sensor open or short circuit	<ul style="list-style-type: none"> Outdoor gas pipe temperature sensor lead wire and connector
H37	Outdoor liquid pipe temperature sensor abnormality	Continuous for 5s	Cooling protection operation only	Outdoor liquid pipe temperature sensor open or short circuit	<ul style="list-style-type: none"> Outdoor liquid pipe temperature sensor lead wire and connector
H38	Indoor/Outdoor mismatch (brand code)	—	—	Brand code not match	<ul style="list-style-type: none"> Check indoor unit and outdoor unit
H39	Abnormal indoor operating unit or standby units	3 times happen within 40 minutes	—	Wrong wiring and connecting pipe, expansion valve abnormality, indoor heat exchanger sensor open circuit	<ul style="list-style-type: none"> Check indoor/outdoor connection wire and connection pipe Indoor heat exchanger sensor lead wire and connector Expansion valve and lead wire and connector

Diagnosis display	Abnormality / Protection control	Abnormality Judgment	Protection Operation	Problem	Check location
H41	Abnormal wiring or piping connection	—	—	Wrong wiring and connecting pipe, expansion valve abnormality	<ul style="list-style-type: none"> • Check indoor/outdoor connection wire and connection pipe • Expansion valve and lead wire and connector
H59	ECONAVI sensor abnormality	Continuous for 25s	—	ECONAVI sensor open or short circuit	<ul style="list-style-type: none"> • ECONAVI sensor • ECONAVI and Indoor PCB
H64	Outdoor high pressure sensor abnormality	Continuous for 1 minutes	—	High pressure sensor open circuit during compressor stop	<ul style="list-style-type: none"> • High pressure sensor • Lead wire and connector
H67	Nanoe abnormality	Nanoe stop for 5 minutes for 3 times	—	Nanoe faulty	<ul style="list-style-type: none"> • PCB • Nanoe system • High voltage
H70	Light sensor abnormality	Continuous for 24 hours	—	Light sensor open or short circuit	<ul style="list-style-type: none"> • Light sensor • Indoor PCB
H85	Abnormal communication between indoor & wireless LAN module	Communication error for 10 minutes for 3 times	—	Wireless LAN LED Off or timer LED blinking	<ul style="list-style-type: none"> • Network adaptor • Router • Network coverage
H97	Outdoor fan motor mechanism lock	2 times happen within 30 minutes	—	Outdoor fan motor lock or feedback abnormal	<ul style="list-style-type: none"> • Outdoor fan motor lead wire and connector • Fan motor lock or block
H98	Indoor high pressure protection	—	—	Indoor high pressure protection (Heating)	<ul style="list-style-type: none"> • Check indoor heat exchanger • Air filter dirty • Air circulation short circuit
H99	Indoor operating unit freeze protection	—	—	Indoor freeze protection (Cooling)	<ul style="list-style-type: none"> • Check indoor heat exchanger • Air filter dirty • Air circulation short circuit
F11	4-way valve switching abnormality	4 times happen within 30 minutes	—	4-way valve switching abnormal	<ul style="list-style-type: none"> • 4-way valve • Lead wire and connector
F17	Indoor standby units freezing abnormality	3 times happen within 40 minutes	—	Wrong wiring and connecting pipe, expansion valve leakage, indoor heat exchanger sensor open circuit	<ul style="list-style-type: none"> • Check indoor/outdoor connection wire and pipe • Indoor heat exchanger sensor lead wire and connector • Expansion valve lead wire and connector
F90	Power factor correction (PFC) circuit protection	4 times happen within 10 minutes	—	Power factor correction circuit abnormal	<ul style="list-style-type: none"> • Outdoor PCB faulty
F91	Refrigeration cycle abnormality	2 times happen within 20 minutes	—	Refrigeration cycle abnormal	<ul style="list-style-type: none"> • Insufficient refrigerant or valve close
F93	Compressor abnormal revolution	4 times happen within 20 minutes	—	Compressor abnormal revolution	<ul style="list-style-type: none"> • Power transistor module faulty or compressor lock
F94	Compressor discharge overshoot protection	4 times happen within 30 minutes	—	Compressor discharge pressure overshoot	<ul style="list-style-type: none"> • Check refrigeration system
F95	Outdoor cooling high pressure protection	4 times happen within 20 minutes	—	Cooling high pressure protection	<ul style="list-style-type: none"> • Check refrigeration system • Outdoor air circuit
F96	Power transistor module overheating protection	4 times happen within 30 minutes	—	Power transistor module overheat	<ul style="list-style-type: none"> • PCB faulty • Outdoor air circuit (fan motor)
F97	Compressor overheating protection	3 times happen within 30 minutes	—	Compressor overheat	<ul style="list-style-type: none"> • Insufficient refrigerant
F98	Total running current protection	3 times happen within 20 minutes	—	Total current protection	<ul style="list-style-type: none"> • Check refrigeration system • Power source or compressor lock
F99	Outdoor direct current (DC) peak detection	Continuous happen for 7 times	—	Power transistor module current protection	<ul style="list-style-type: none"> • Power transistor module faulty or compressor lock

17.4 Self-diagnosis Method

17.4.1 H11 (Indoor/Outdoor Abnormal Communication)

Malfunction Decision Conditions

- During startup and operation of cooling and heating, the data received from outdoor unit in indoor unit signal transmission is checked whether it is normal.

Malfunction Caused

- Faulty indoor unit PCB.
- Faulty outdoor unit PCB.
- Indoor unit-outdoor unit signal transmission error due to wiring error.
- Indoor unit-outdoor unit signal transmission error due to breaking of wire in the connection wires between the indoor and outdoor units.

Troubleshooting

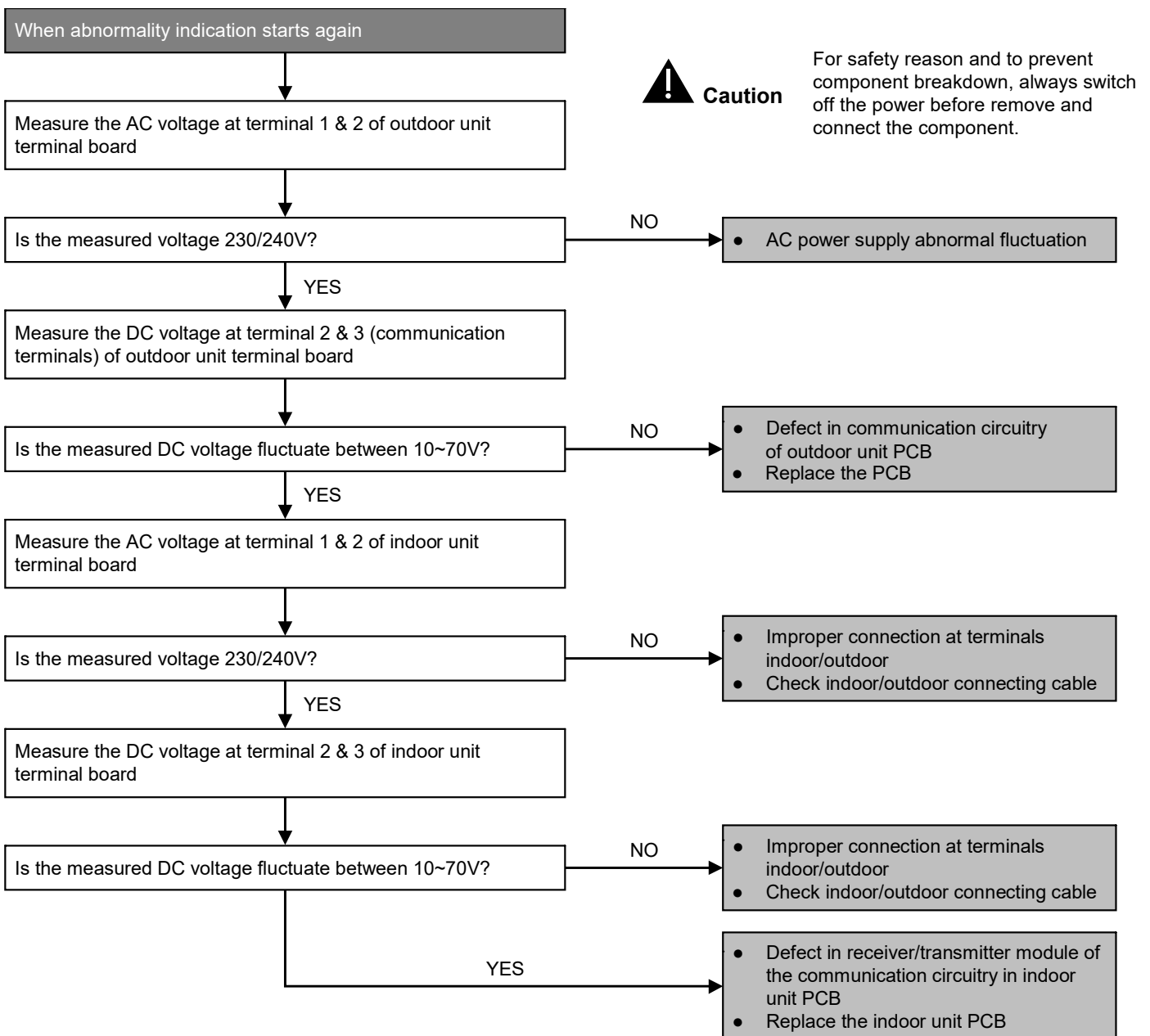

17.4.2 H12 (Indoor/Outdoor Capacity Rank Mismatched)

Malfunction Decision Conditions

- During startup, error code appears when different types of indoor and outdoor units are interconnected.

Malfunction Caused

- Wrong models interconnected.
- Wrong indoor unit or outdoor unit PCBs mounted.
- Indoor unit or outdoor unit PCBs defective.
- Indoor-outdoor unit signal transmission error due to wrong wiring.
- Indoor-outdoor unit signal transmission error due to breaking of wire 3 in the connection wires between the indoor and outdoor units.

Troubleshooting

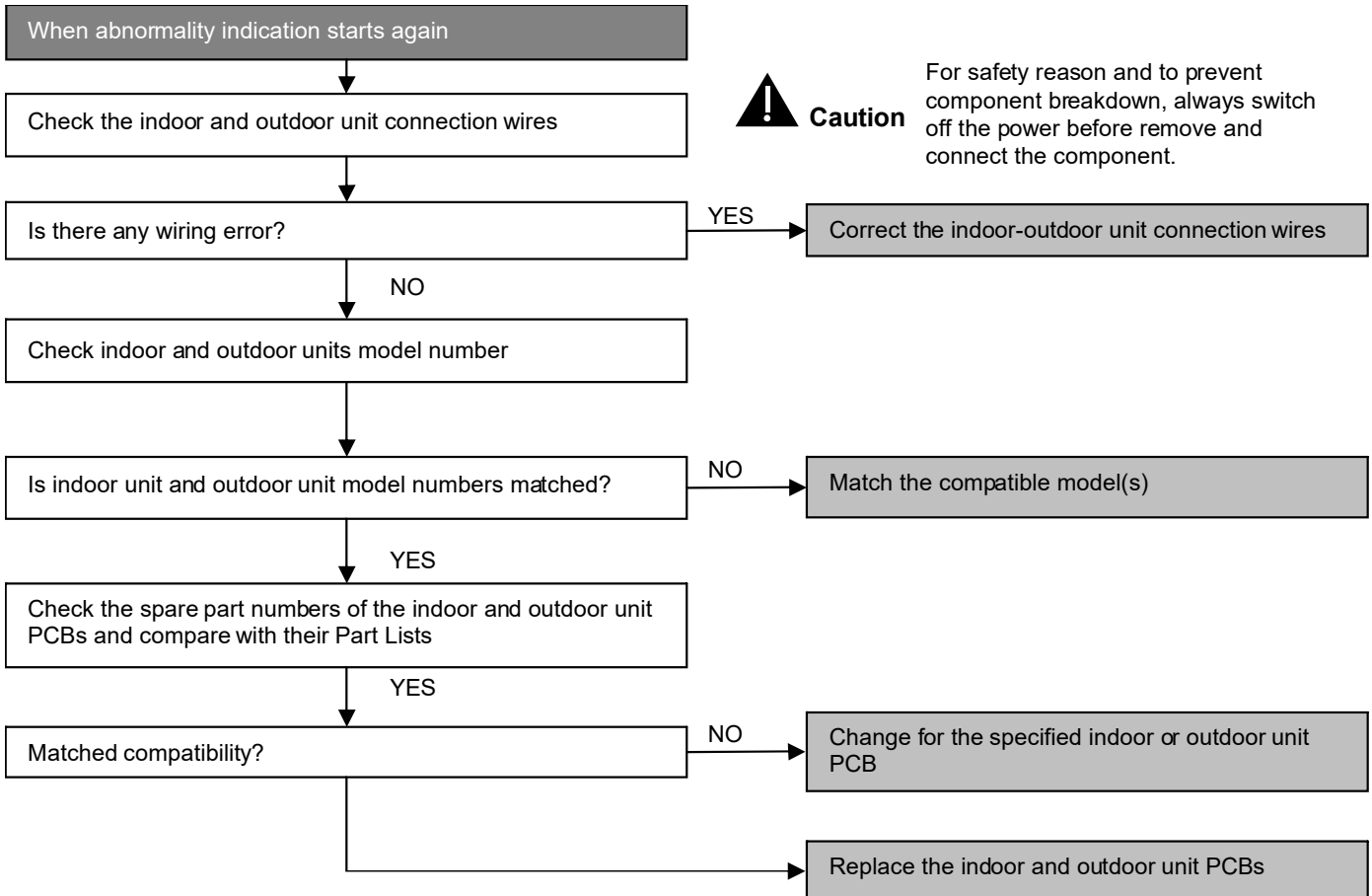

17.4.3 H14 (Indoor Intake Air Temperature Sensor Abnormality)

Malfunction Decision Conditions

- During startup and operation of cooling and heating, the temperatures detected by the indoor intake air temperature sensor are used to determine sensor errors.

Malfunction Caused

- Faulty connector connection.
- Faulty sensor.
- Faulty PCB.

Troubleshooting

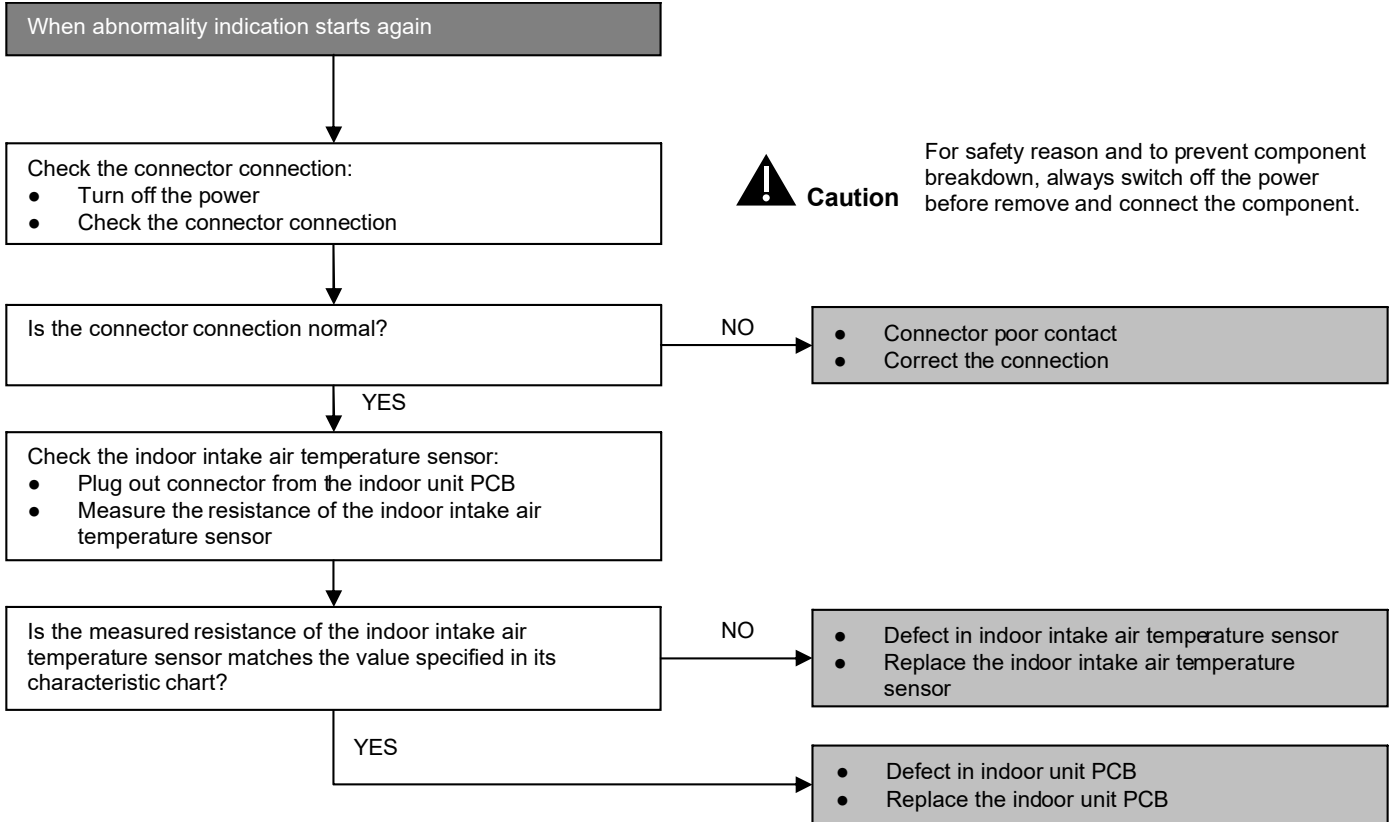

Caution

For safety reason and to prevent component breakdown, always switch off the power before remove and connect the component.

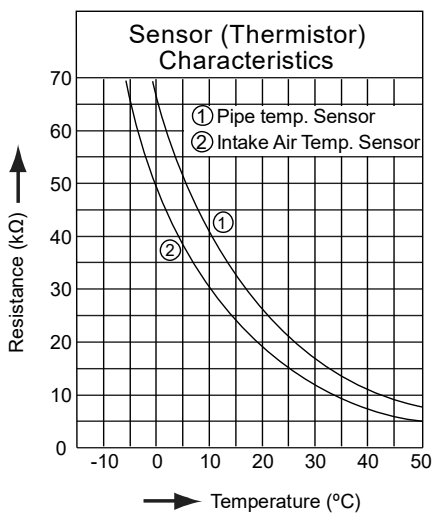

17.4.4 H15 (Compressor Temperature Sensor Abnormality)

Malfunction Decision Conditions

- During startup and operation of cooling and heating, the temperatures detected by the outdoor compressor temperature sensor are used to determine sensor errors.

Malfunction Caused

- Faulty connector connection.
- Faulty sensor.
- Faulty PCB.

Troubleshooting

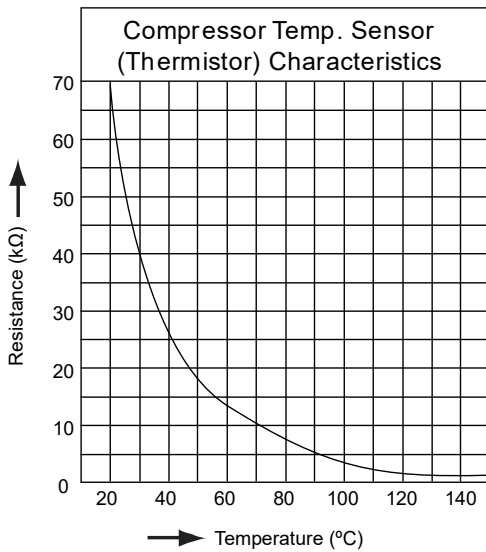
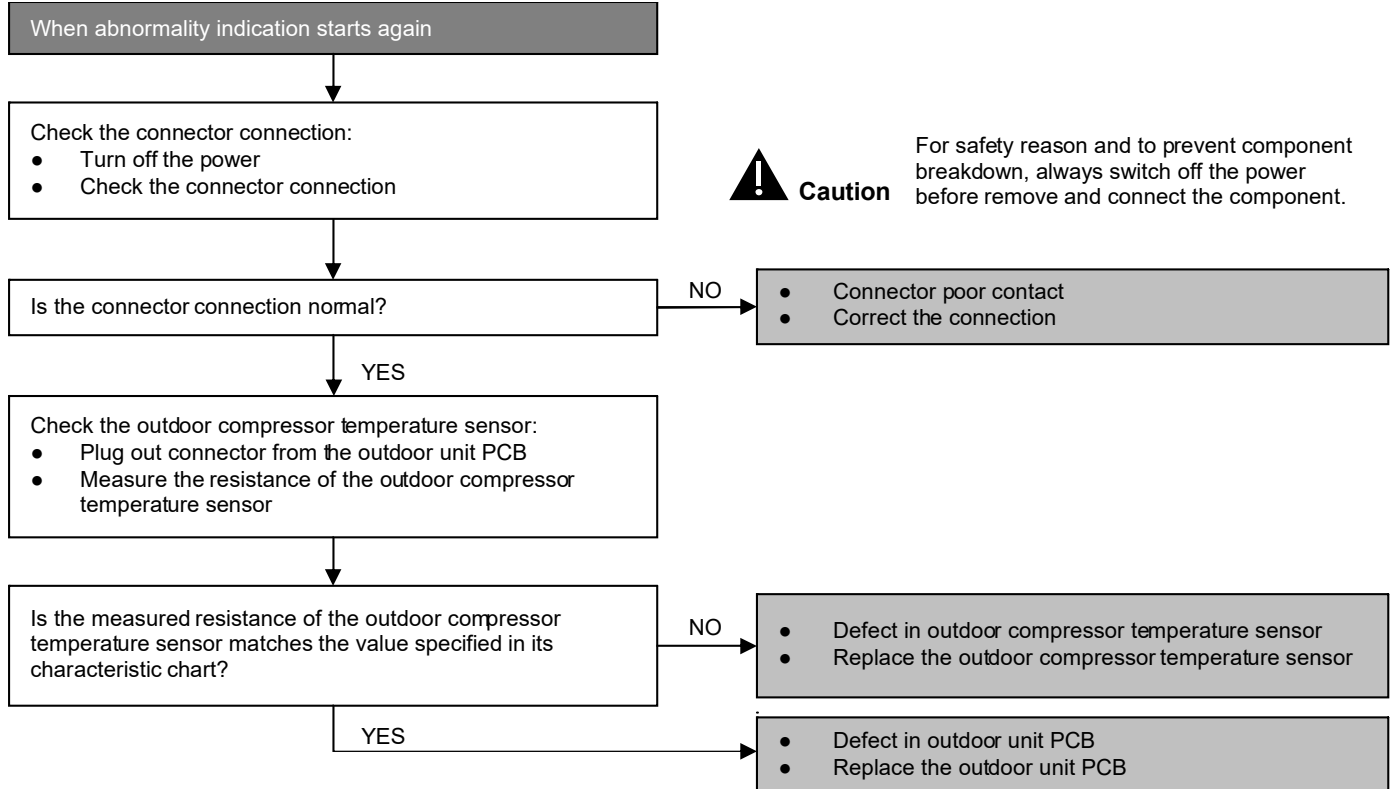

17.4.5 H16 (Outdoor Current Transformer)

Malfunction Decision Conditions

- An input current, detected by Current Transformer CT, is below threshold value when the compressor is operating at certain frequency value for 3 minutes.

Malfunction Caused

- Lack of gas
- Broken CT (current transformer)
- Broken Outdoor PCB

Troubleshooting

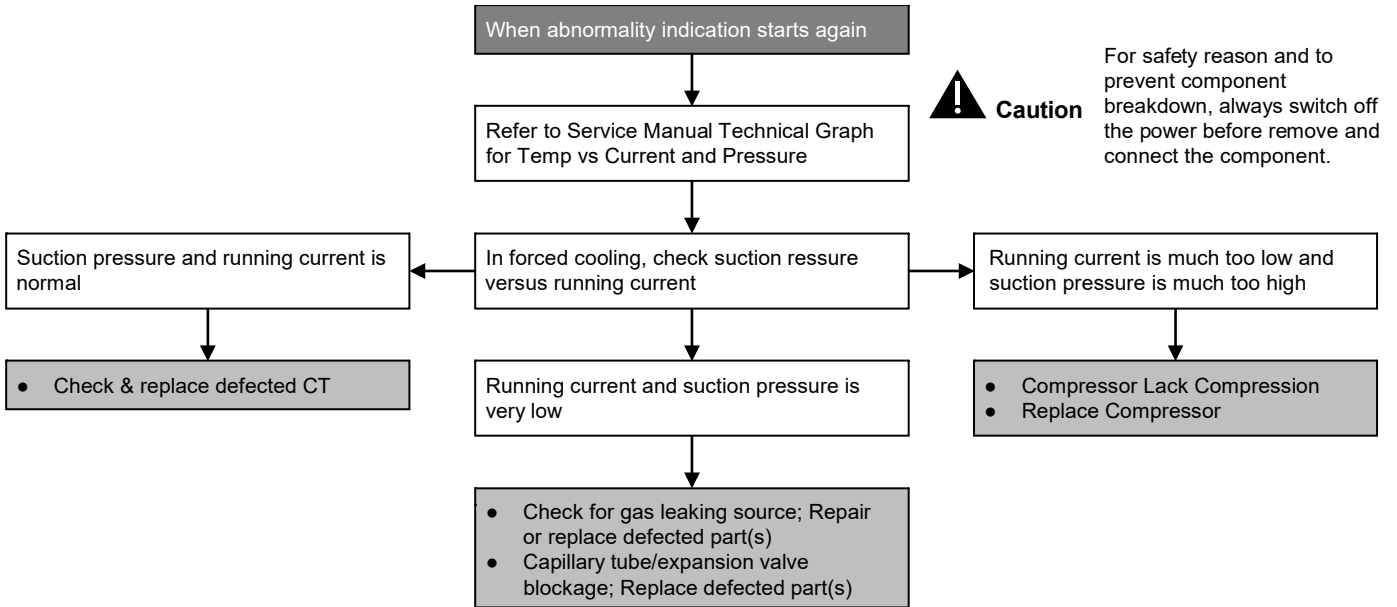

17.4.6 H19 (Indoor Fan Motor – DC Motor Mechanism Locked)

Malfunction Decision Conditions

- The rotation speed detected by the Hall IC during fan motor operation is used to determine abnormal fan motor (feedback of rotation > 2550rpm or < 50rpm)

Malfunction Caused

- Operation stops due to short circuit inside the fan motor winding.
- Operation stops due to breaking of wire inside the fan motor.
- Operation stops due to breaking of fan motor lead wires.
- Operation stops due to Hall IC malfunction.
- Operation error due to faulty indoor unit PCB.

Troubleshooting

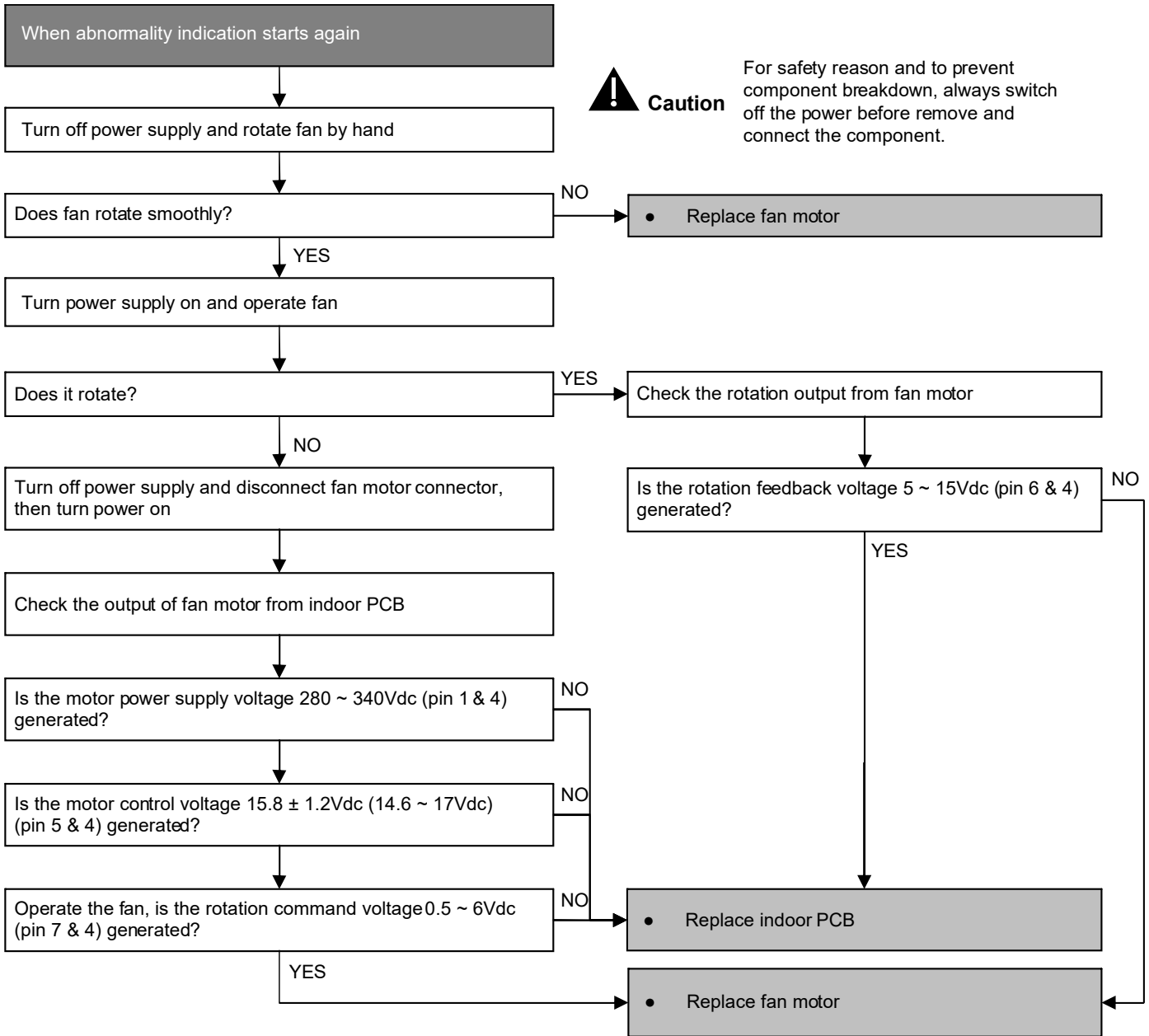

17.4.7 H23 (Indoor Pipe Temperature Sensor Abnormality)

Malfunction Decision Conditions

- During startup and operation of cooling and heating, the temperatures detected by the indoor heat exchanger temperature sensor are used to determine sensor errors.

Malfunction Caused

- Faulty connector connection.
- Faulty sensor.
- Faulty PCB.

Troubleshooting

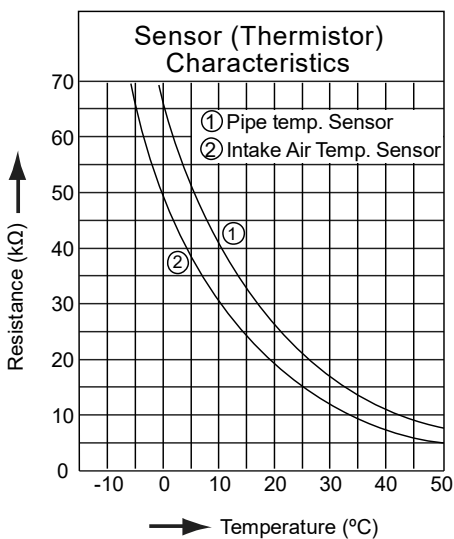
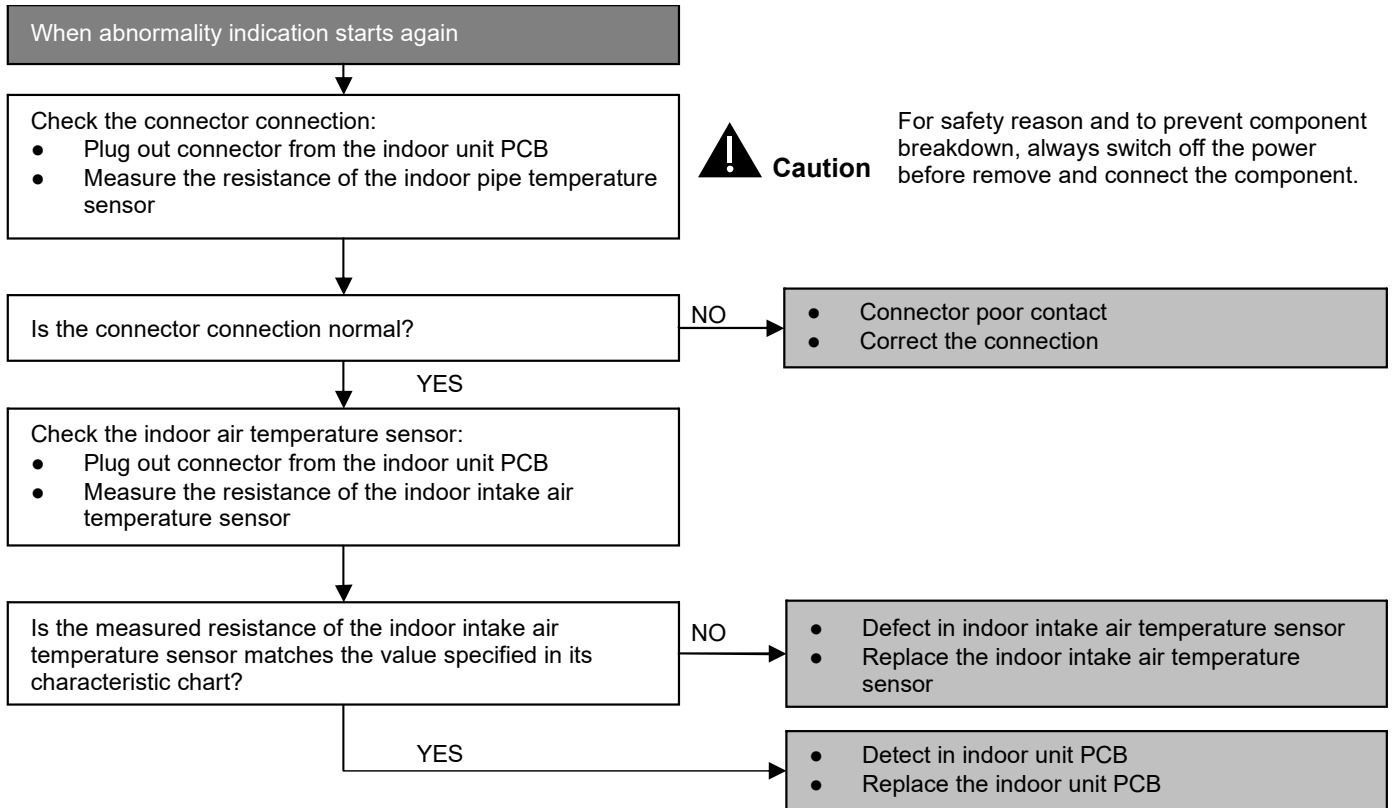

17.4.8 H27 (Outdoor Air Temperature Sensor Abnormality)

Malfunction Decision Conditions

- During startup and operation of cooling and heating, the temperatures detected by the outdoor air temperature sensor are used to determine sensor errors.

Malfunction Caused

- Faulty connector connection.
- Faulty sensor.
- Faulty PCB.

Troubleshooting

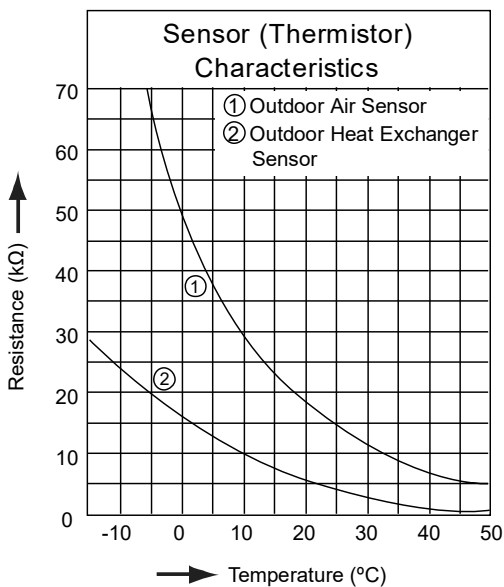
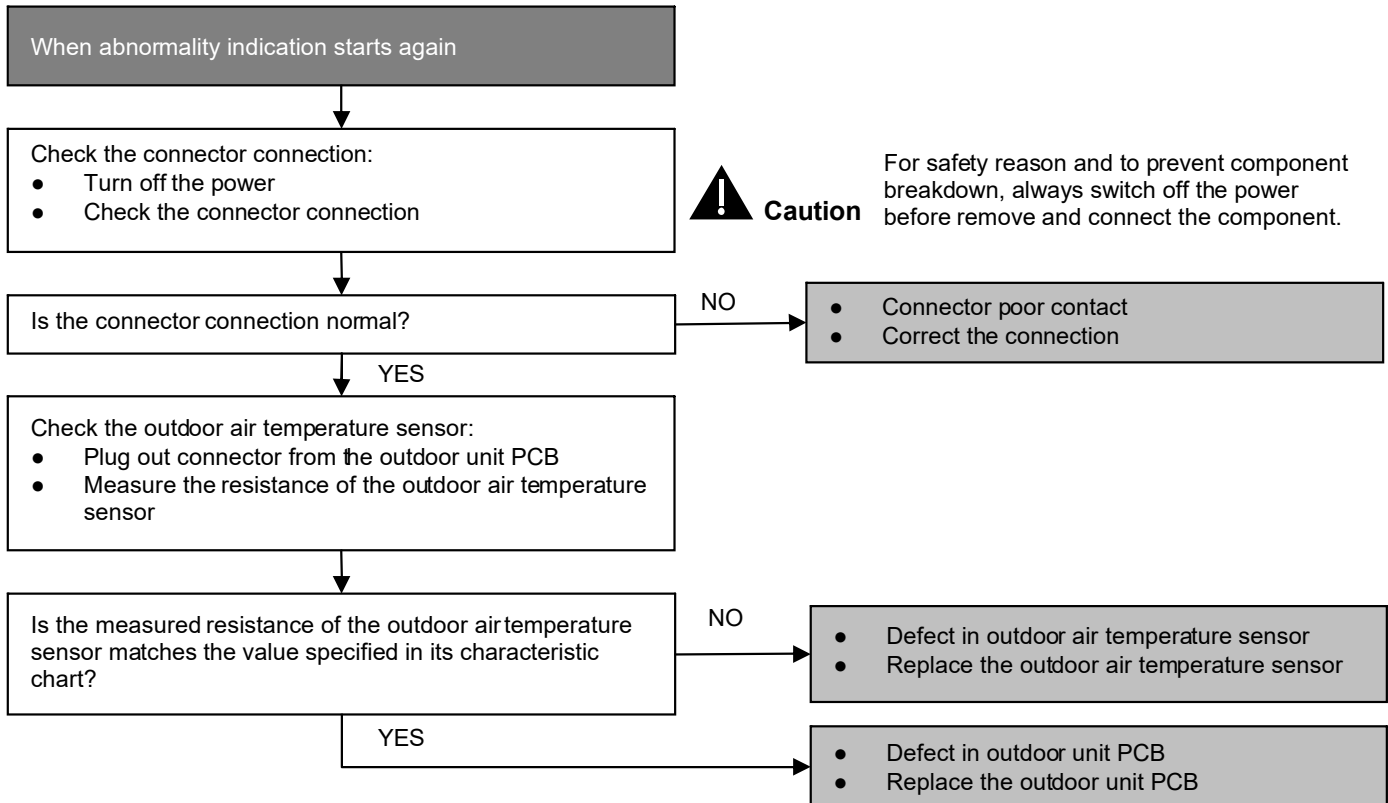

17.4.9 H28 (Outdoor Pipe Temperature Sensor Abnormality)

Malfunction Decision Conditions

- During startup and operation of cooling and heating, the temperatures detected by the outdoor pipe temperature sensor are used to determine sensor errors.

Malfunction Caused

- Faulty connector connection.
- Faulty sensor.
- Faulty PCB.

Troubleshooting

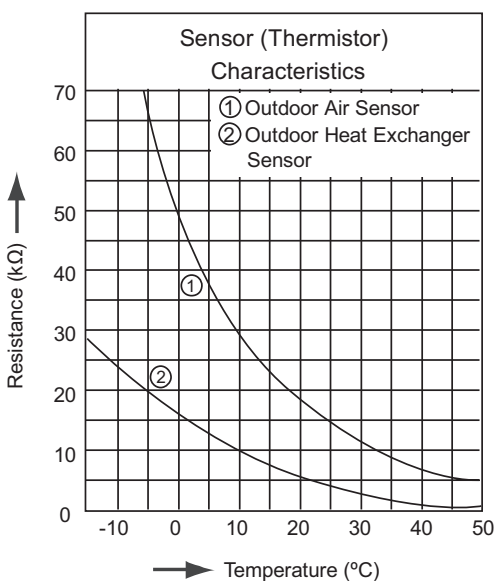
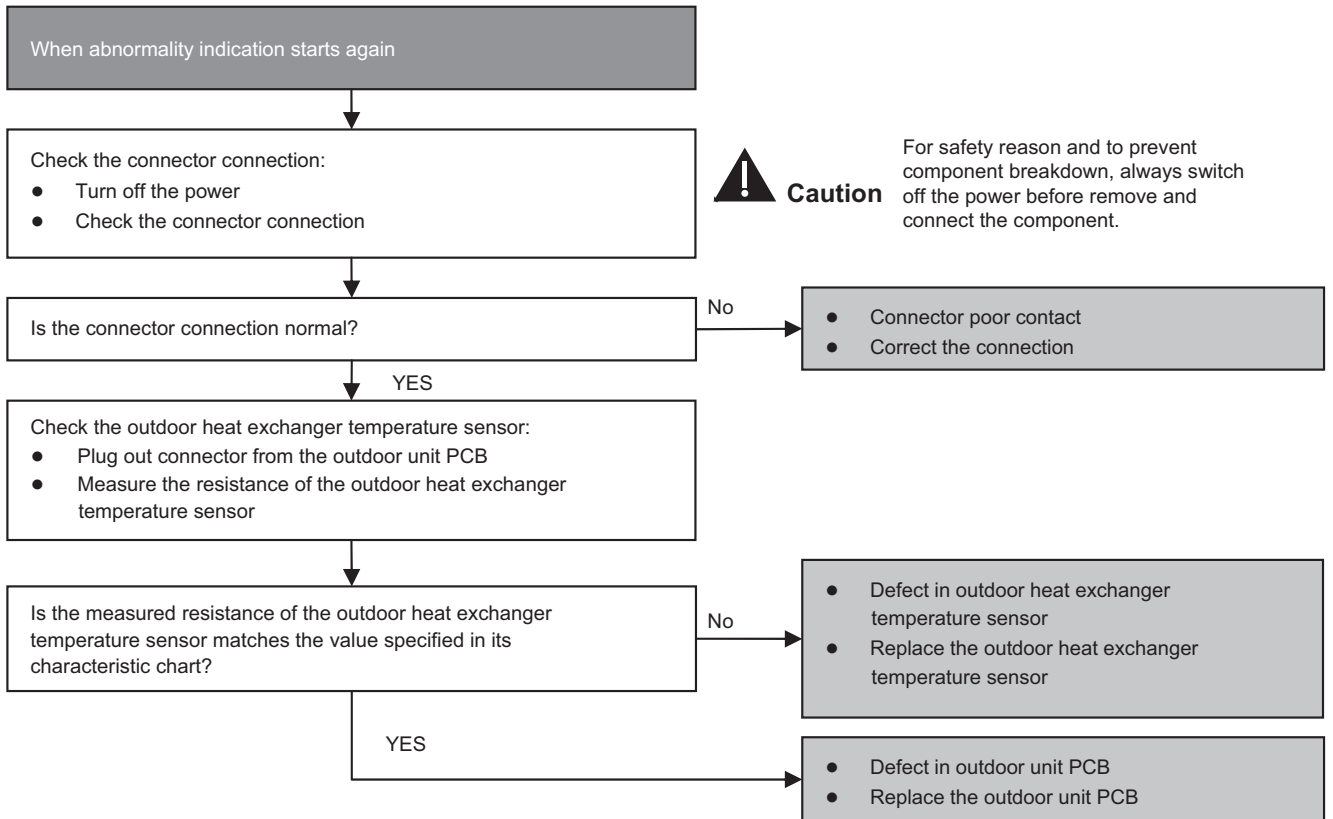

17.4.10 H30 (Compressor Discharge Temperature Sensor Abnormality)

Malfunction Decision Conditions

- During startup and operation of cooling and heating, the temperatures detected by the outdoor discharge pipe temperature sensor are used to determine sensor errors.

Malfunction Caused

- Faulty connector connection.
- Faulty sensor.
- Faulty PCB.

Troubleshooting

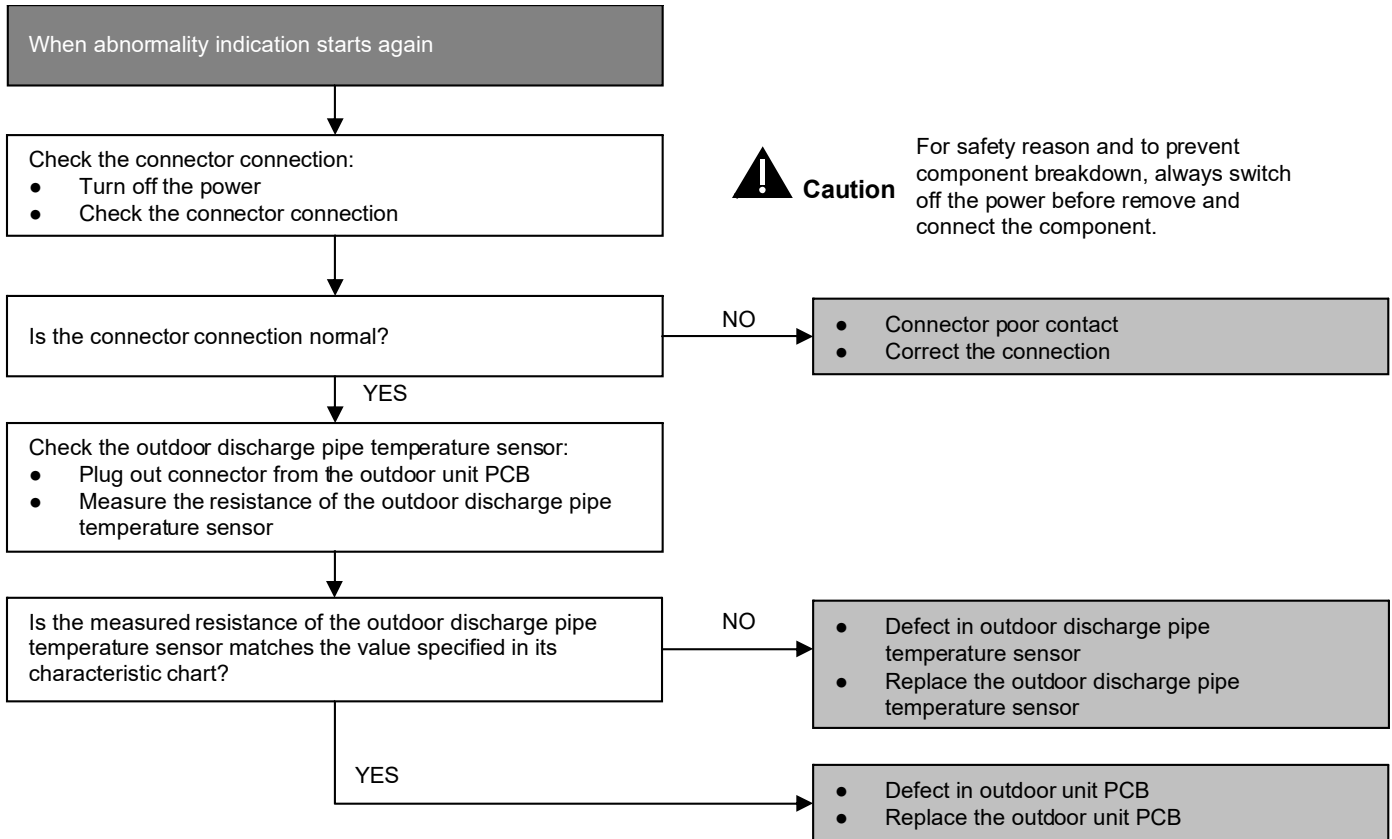

17.4.11 H32 (Outdoor Heat Exchanger Temperature Sensor 2 Abnormality)

Malfunction Decision Conditions

- During startup and operation of cooling and heating, the temperatures detected by the outdoor heat exchanger temperature sensor are used to determine sensor errors.

Malfunction Caused

- Faulty connector connection.
- Faulty sensor.
- Faulty PCB.

Troubleshooting

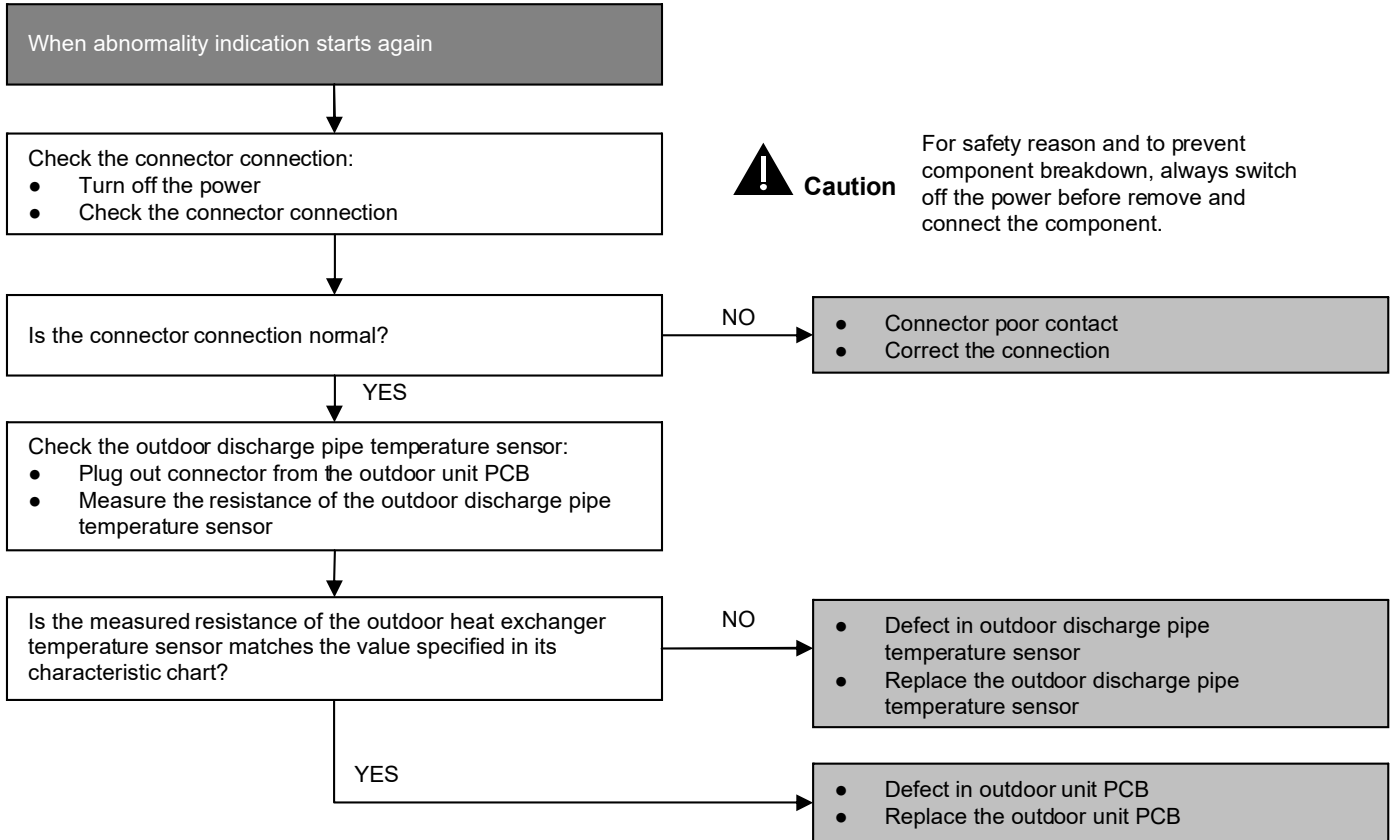

17.4.12 H33 (Unspecified Voltage between Indoor and Outdoor)

Malfunction Decision Conditions

- The supply power is detected for its requirement by the indoor/outdoor transmission.

Malfunction Caused

- Wrong models interconnected.
- Wrong indoor unit and outdoor unit PCBs used.
- Indoor unit or outdoor unit PCB defective.

Troubleshooting

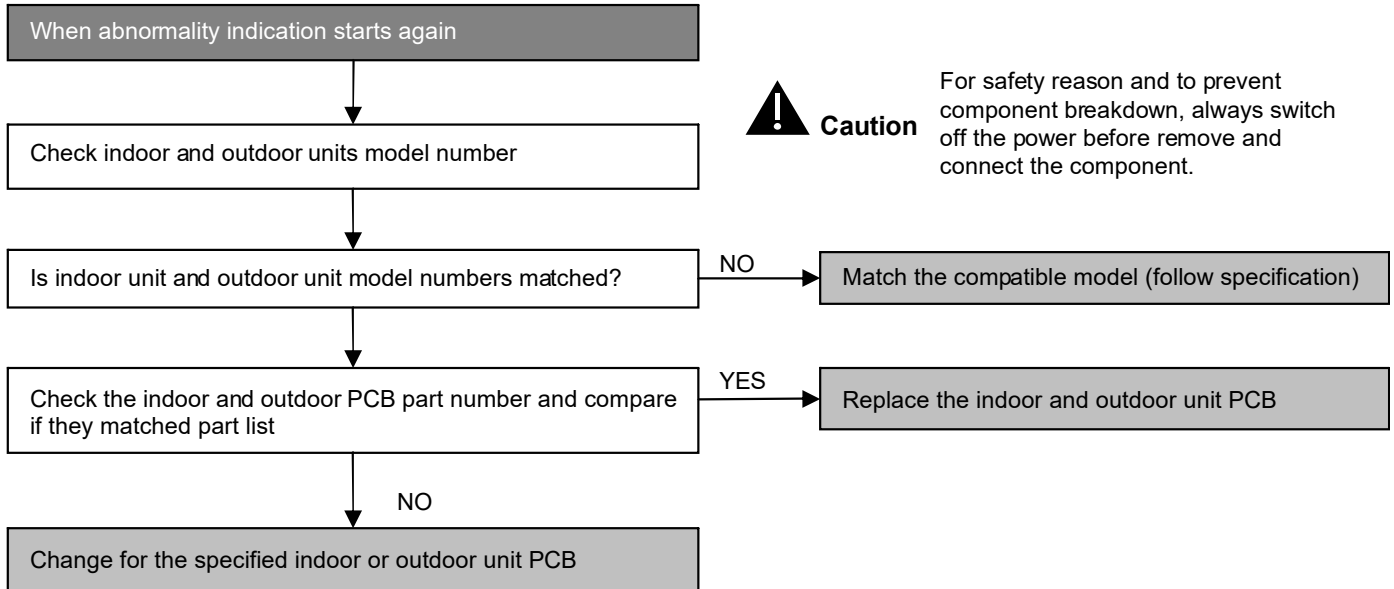

17.4.13 H34 (Outdoor Heat Sink Temperature Sensor Abnormality)

Malfunction Decision Conditions

- During startup and operation of cooling and heating, the temperatures detected by the outdoor heat sink temperature sensor are used to determine sensor errors.

Malfunction Caused

- Faulty connector connection.
- Faulty sensor.
- Faulty PCB.

Troubleshooting

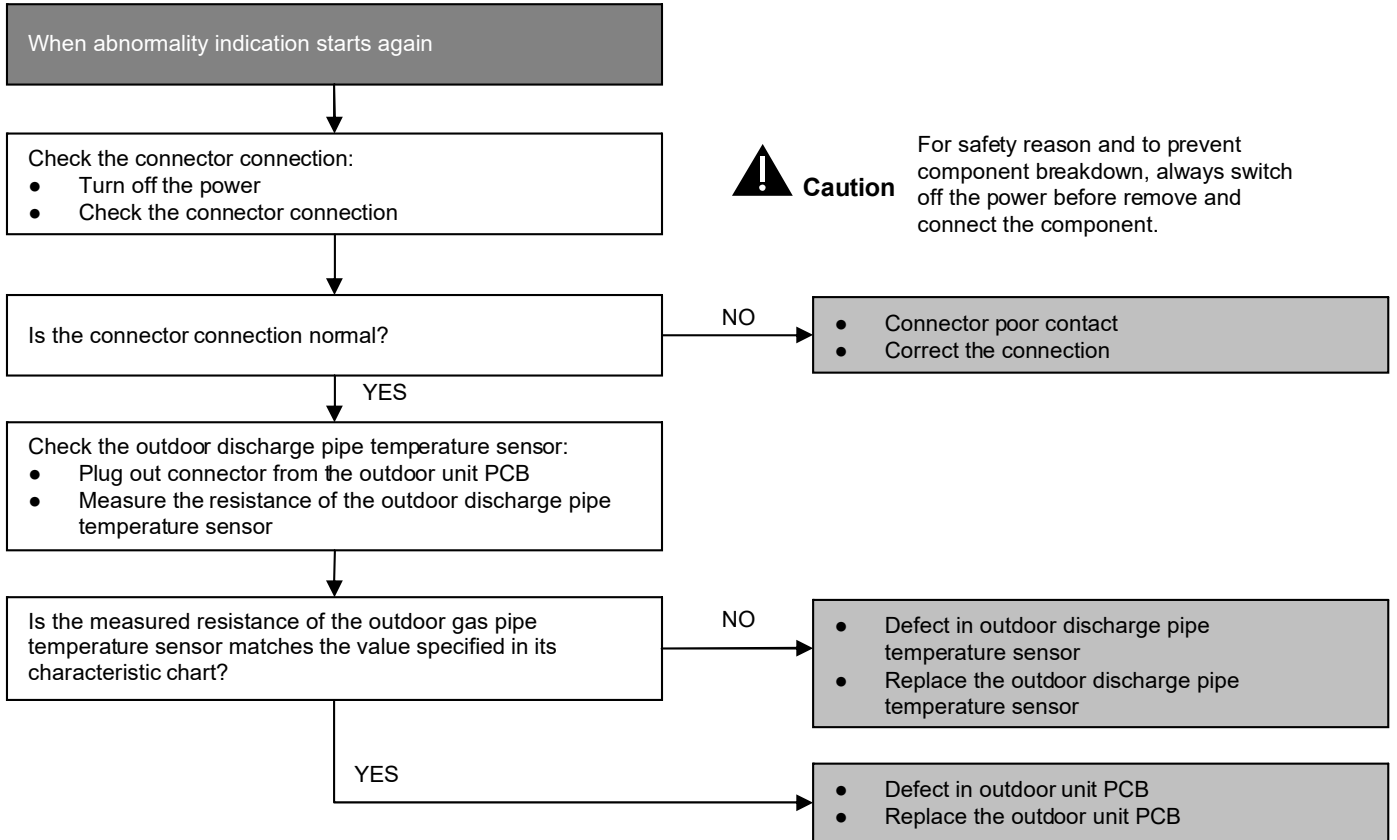

17.4.14 H36 (Outdoor Gas Pipe Sensor Abnormality)

Malfunction Decision Conditions

- During startup and operation of cooling and heating, the temperatures detected by the outdoor gas pipe temperature sensor are used to determine sensor errors.

Malfunction Caused

- Faulty connector connection.
- Faulty sensor.
- Faulty PCB.

Troubleshooting

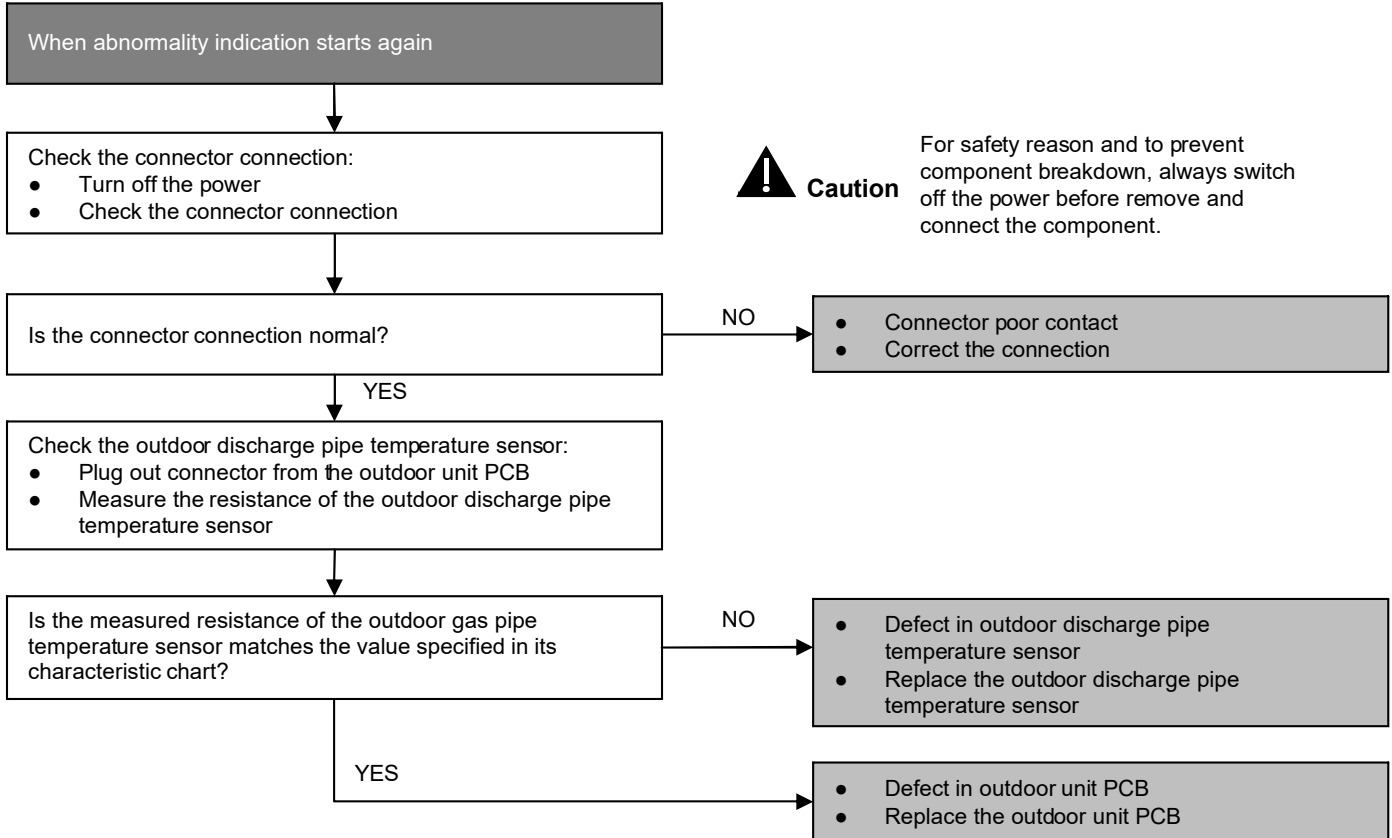

17.4.15 H37 (Outdoor Liquid Pipe Temperature Sensor Abnormality)

Malfunction Decision Conditions

- During startup and operation of cooling and heating, the temperatures detected by the outdoor liquid pipe temperature sensor are used to determine sensor errors.

Malfunction Caused

- Faulty connector connection.
- Faulty sensor.
- Faulty PCB.

Troubleshooting

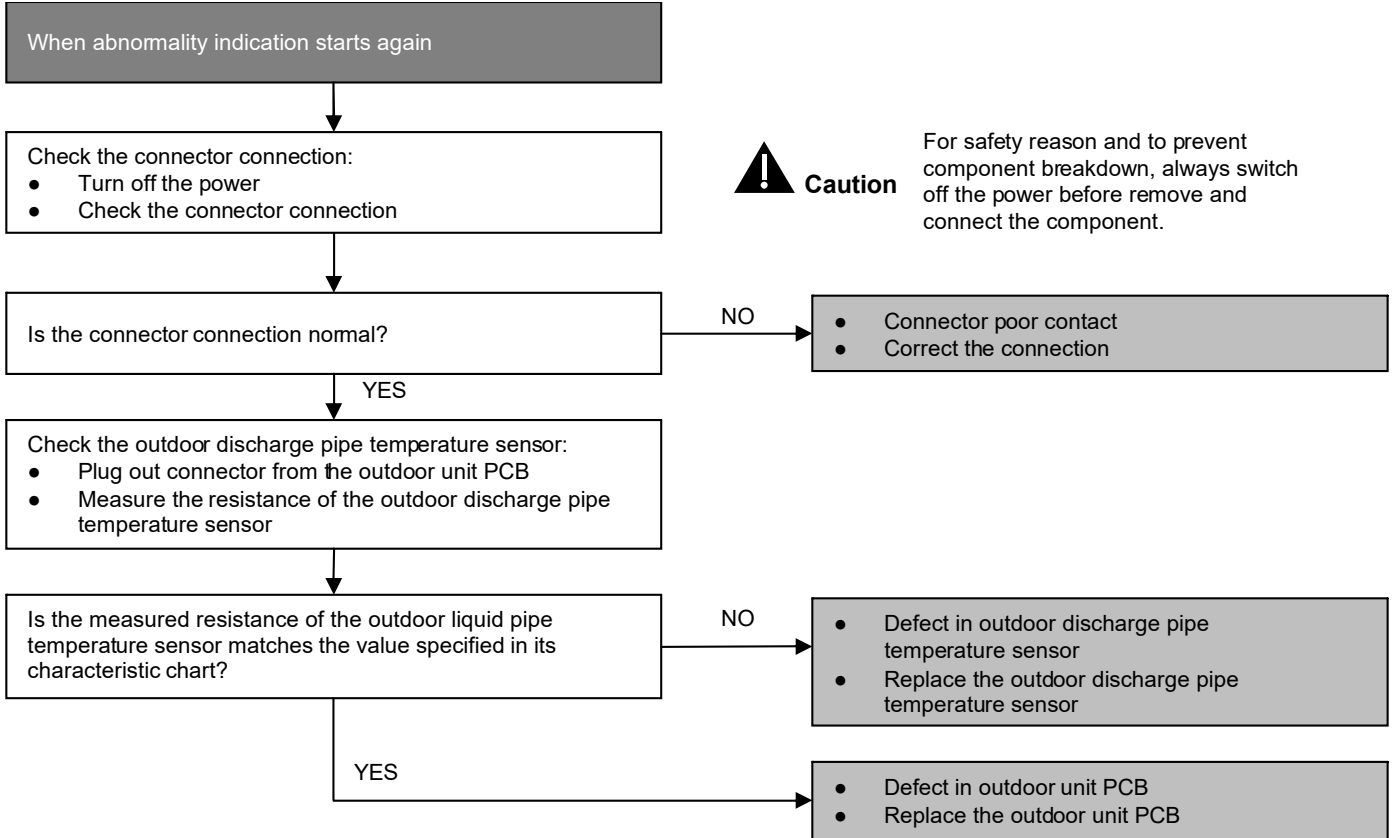

17.4.16 H97 (Outdoor Fan Motor – DC Motor Mechanism Locked)

Malfunction Decision Conditions

- The rotation speed detected by the Hall IC during fan motor operation is used to determine abnormal fan motor.

Malfunction Caused

- Operation stops due to short circuit inside the fan motor winding.
- Operation stops due to breaking of wire inside the fan motor.
- Operation stops due to breaking of fan motor lead wires.
- Operation stops due to Hall IC malfunction.
- Operation error due to faulty outdoor unit PCB.

Troubleshooting

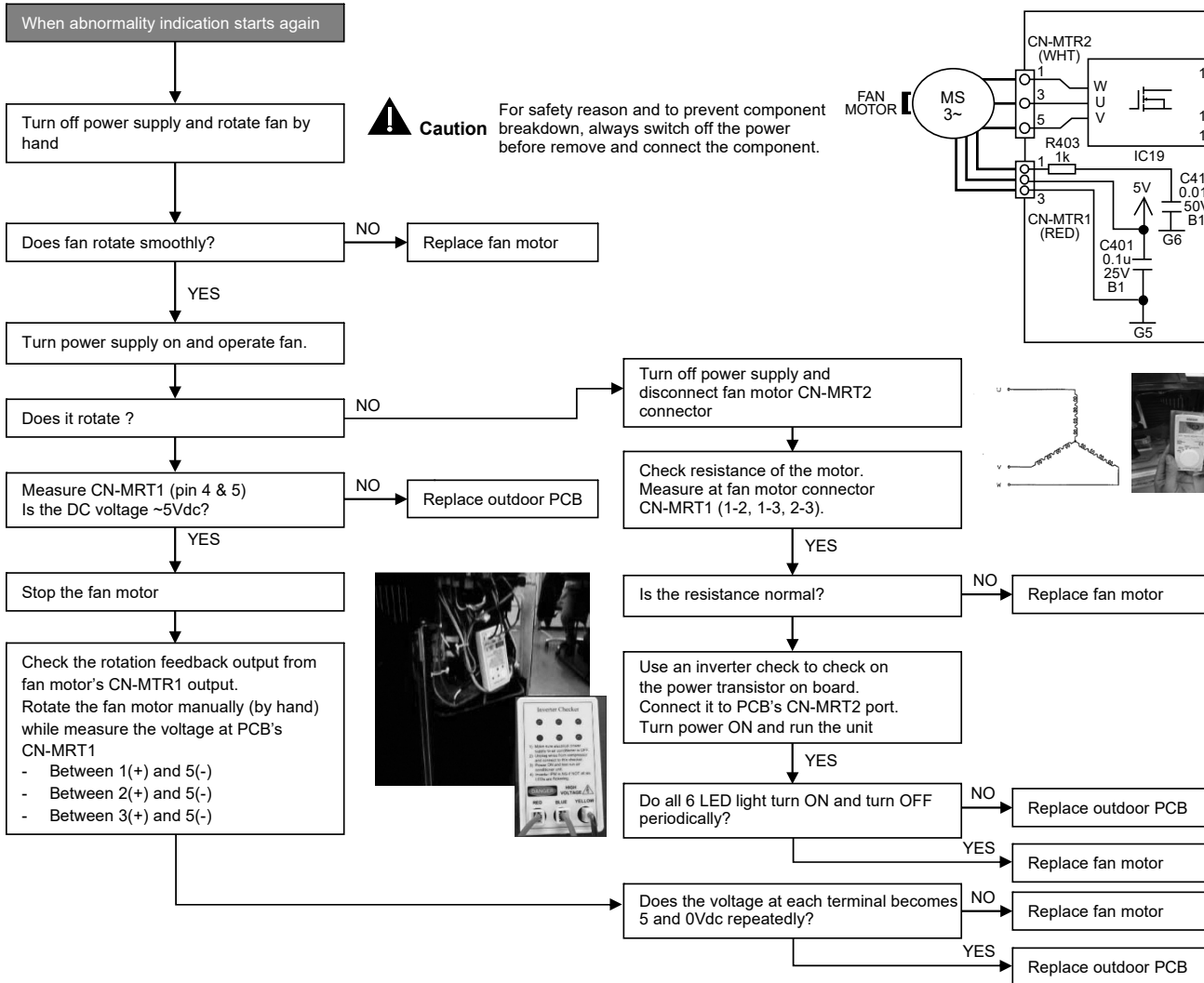

17.4.17 H98 (Error Code Stored in Memory and no alarm is triggered / no TIMER LED flashing)

Malfunction Decision Conditions

- Indoor high pressure is detected when indoor heat exchanger is detecting very high temperature when the unit is operating in heating operation.
- Phenomena: unit is stopping and re-starting very often in heating mode

Malfunction Caused

- Indoor heat exchanger thermistor
- Clogged air filter or heat exchanger
- Over-bent pipe (liquid side)

Troubleshooting

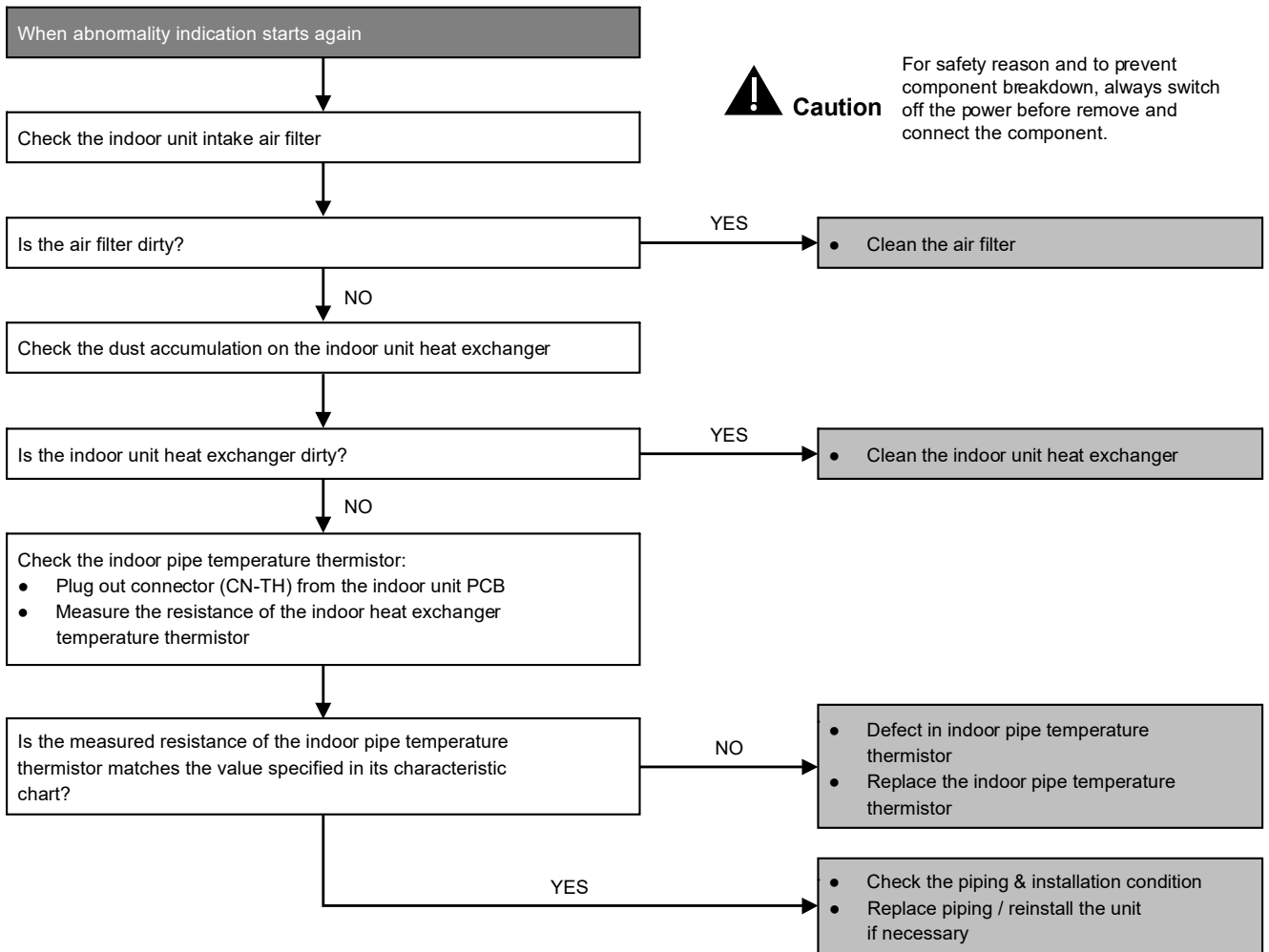

17.4.18 H99 (Indoor Freeze Prevention Protection: Cooling or Soft Dry)

Error Code will not display (no Timer LED blinking) but store in EEPROM

Malfunction Decision Conditions

- Freeze prevention control takes place (when indoor pipe temperature is lower than 2°C)

Malfunction Caused

- Air short circuit at indoor unit
- Clogged indoor unit air filter
- Dust accumulation on the indoor unit heat exchanger
- 2/3 way valve closed
- Faulty indoor unit fan motor
- Refrigerant shortage (refrigerant leakage)
- Clogged expansion valve or strainer
- Faulty indoor pipe temperature sensor
- Faulty indoor unit PCB

Troubleshooting

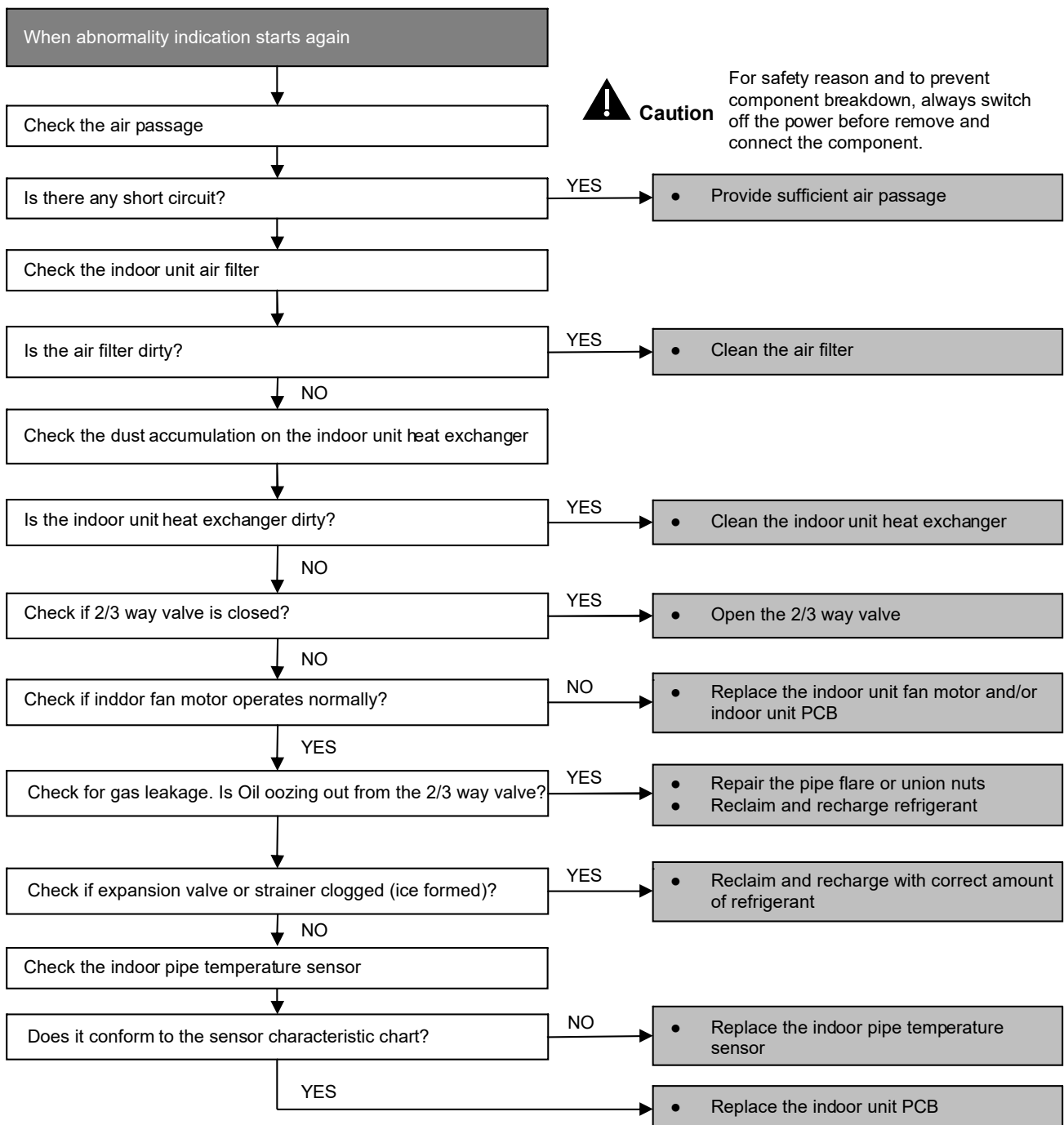

17.4.19 F11 (4-way Valve Switching Failure)

Malfunction Decision Conditions

- When indoor heat exchanger is cold during heating (except deice) or when indoor heat exchanger is hot during cooling and compressor operating, the 4-way valve is detected as malfunction.

Malfunction Caused

- Indoor heat exchanger (pipe) thermistor
- 4-way valve malfunction

Troubleshooting

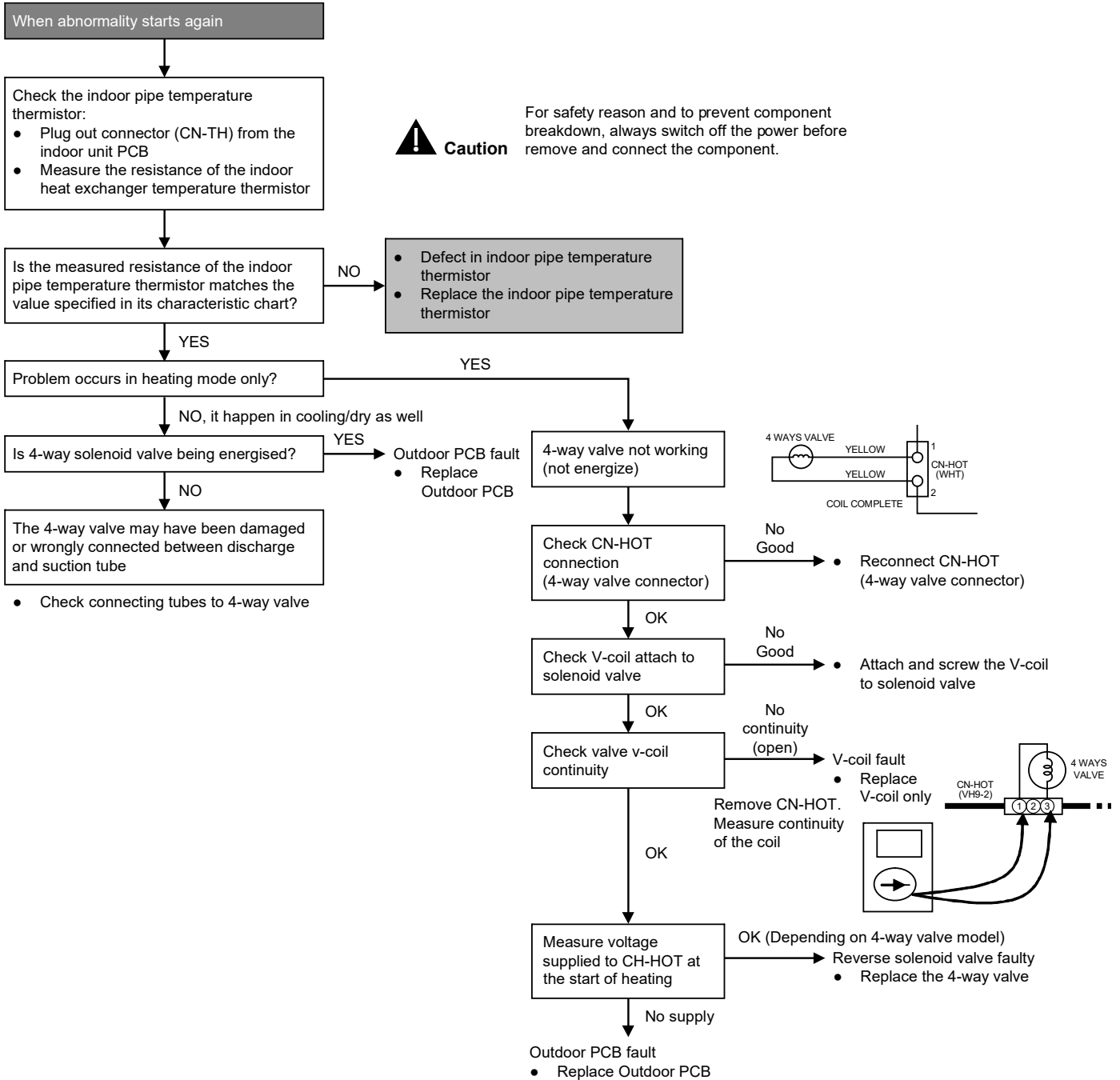

* Check gas side pipe – for hot gas flow in cooling mode

17.4.20 F17 (Indoor Standby Units Freezing Abnormality)

Malfunction Decision Conditions

- When the different between indoor intake air temperature and indoor pipe temperature is above 10°C or indoor pipe temperature is below -1.0°C.

Remark:

When the indoor standby unit is freezing, the outdoor unit transfers F17 error code to the corresponding indoor unit and H39 to other indoor unit(s).

Malfunction Caused

- Wrong wiring connection
- Faulty sensor
- Faulty expansion valve

Troubleshooting

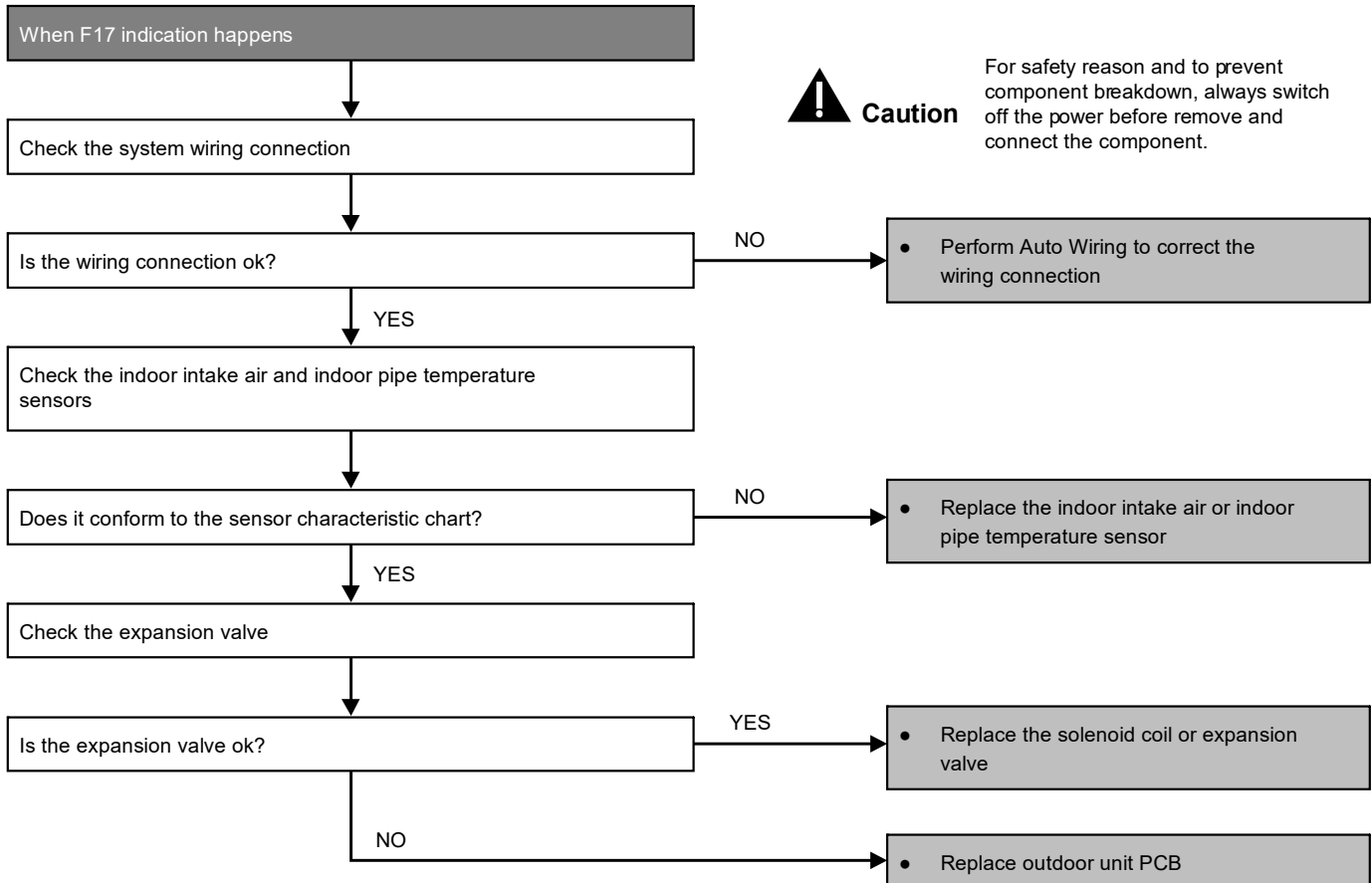

17.4.21 F90 (Power Factor Correction Protection)

Malfunction Decision Conditions

- To maintain DC voltage level supply to power transistor.
- To detect high DC voltage level after rectification.

Malfunction Caused

- During startup and operation of cooling and heating, when Power Factor Correction (PFC) protection circuitry at the outdoor unit main PCB senses abnormal DC voltage level for power transistors.
- When DC voltage detected is LOW, transistor switching will turn ON by controller to push-up the DC level.
- When DC voltage detected is HIGH (391Vdc – 425Vdc), active LOW signal will send by the controller to turn OFF relay RY-C.

Troubleshooting

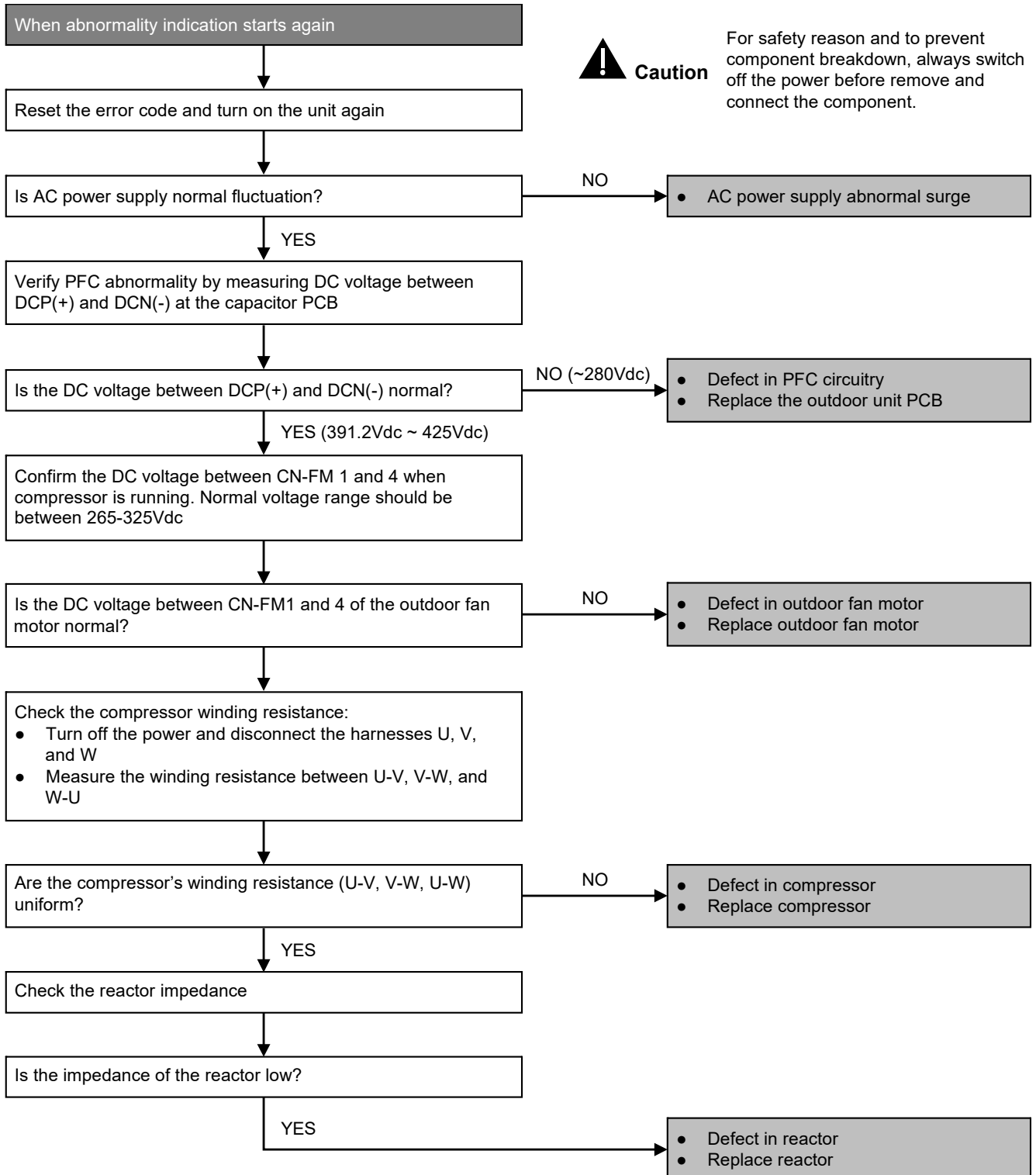

17.4.22 F91 (Refrigeration Cycle Abnormality)

Malfunction Decision Conditions

- The input current is low while the compressor is running at higher than the setting frequency.

Malfunction Caused

- Lack of gas.
- 3-way valve close.

Troubleshooting

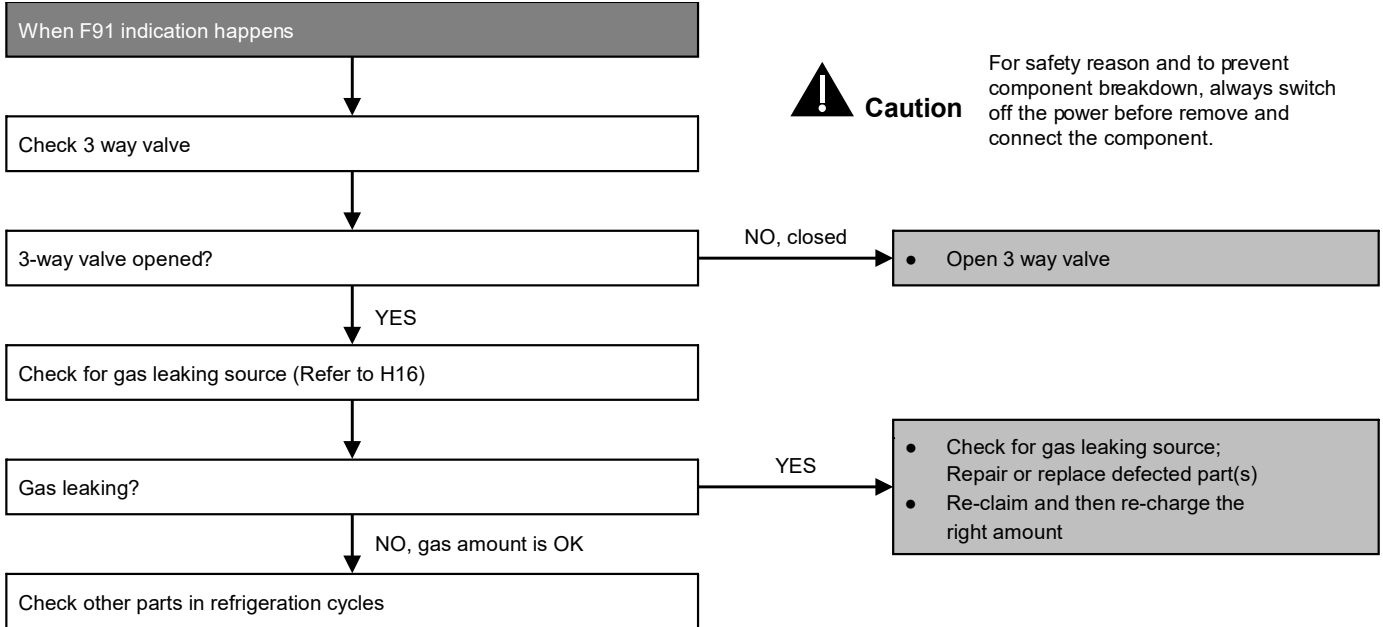

17.4.23 F93 (Compressor Rotation Failure)

Malfunction Decision Conditions

- A compressor rotation failure is detected by checking the compressor running condition through the position detection circuit.

Malfunction Caused

- Compressor terminal disconnect
- Faulty Outdoor PCB
- Faulty compressor

Troubleshooting

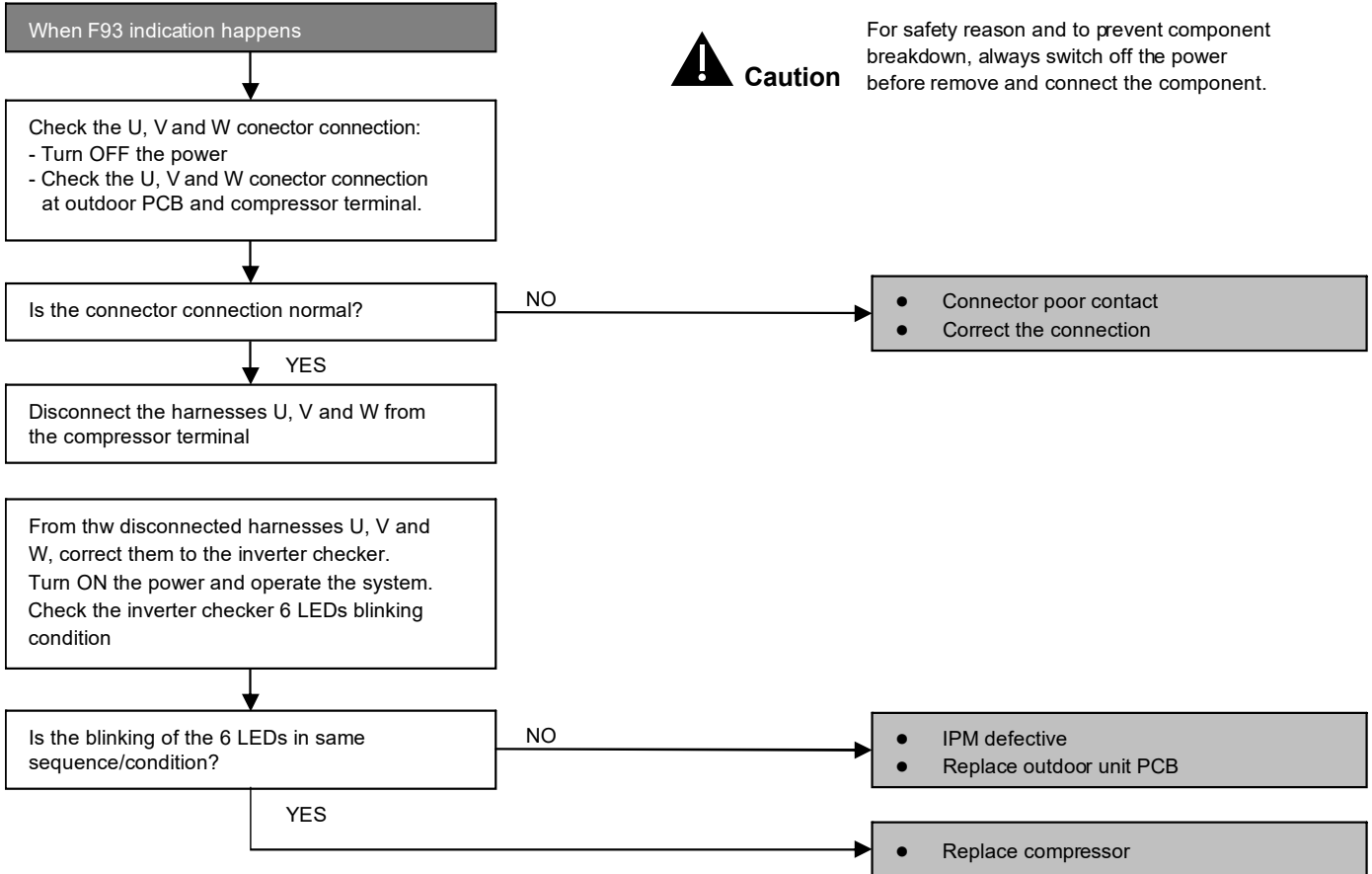

17.4.24 F95 (Outdoor High Pressure Protection: Cooling or Soft Dry)

Malfunction Decision Conditions

- During operation of cooling or soft dry, when outdoor unit heat exchanger high temperature data is detected by the outdoor unit heat exchanger thermistor.

Malfunction Caused

- Outdoor heat exchanger temperature rise due to short-circuit of hot discharge air flow.
- Outdoor heat exchanger temperature rise due to defective of outdoor fan motor.
- Outdoor heat exchange temperature rise due to defective outdoor heat exchanger thermistor.
- Outdoor heat exchanger temperature rise due to defective of outdoor unit PCB.

Troubleshooting

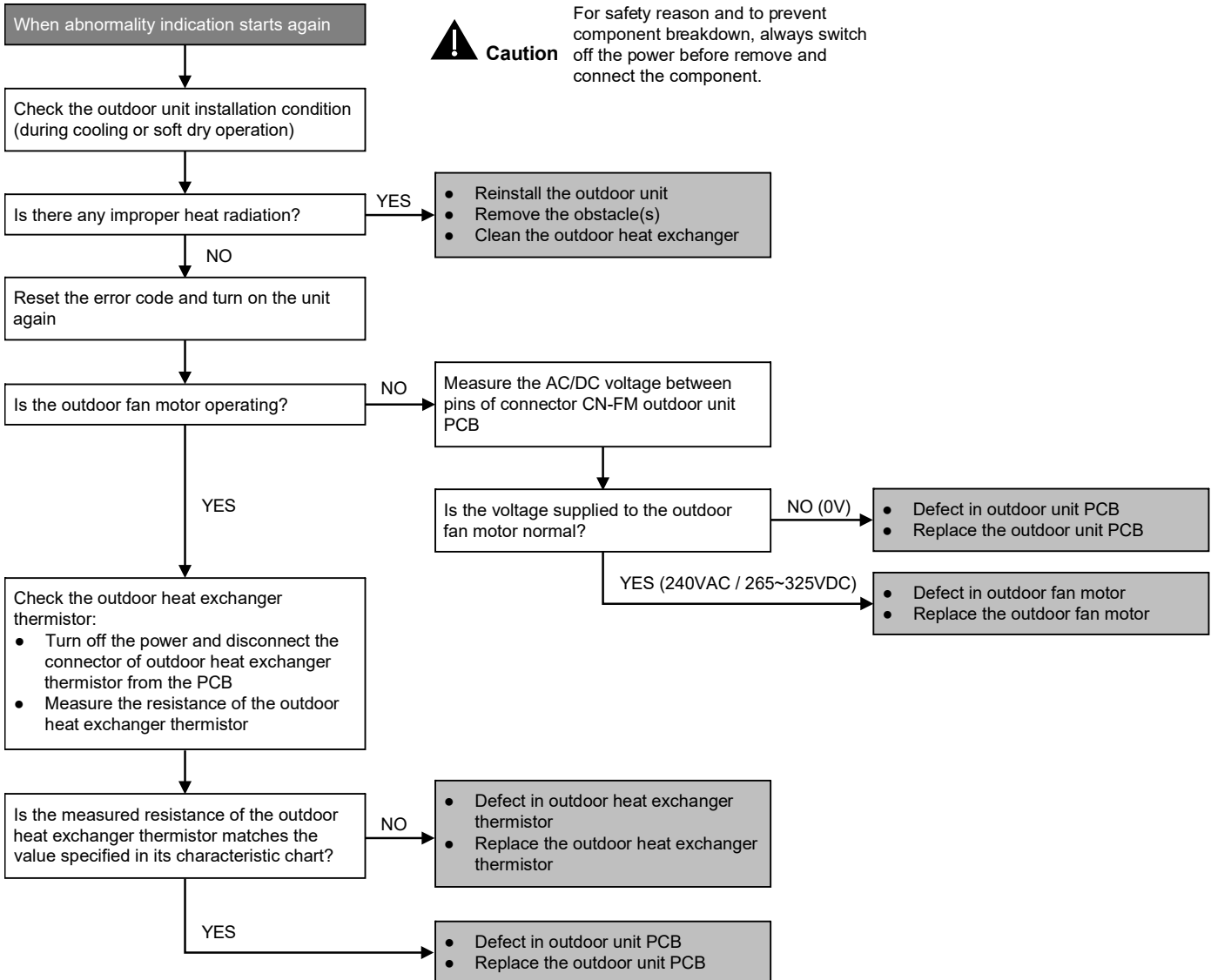

17.4.25 F96 (IPM Overheating)

Malfunction Decision Conditions

- During operating of cooling and heating, when IPM temperature data (100°C) is detected by the IPM temperature sensor.

Multi Models only

- Compressor Overheating: During operation of cooling and heating, when the compressor OL is activated.
- Heat Sink Overheating: During operation of cooling and heating, when heat sink temperature data (90°C) is detected by the heat sink temperature sensor.

Malfunction Caused

- IPM overheats due to short circuit of hot discharge air flow.
- IPM overheats due to defective of outdoor fan motor.
- IPM overheats due to defective of internal circuitry of IPM.
- IPM overheats due to defective IPM temperature sensor.

Multi Models Only

- Compressor OL connector poor contact.
- Compressor OL faulty.

Troubleshooting

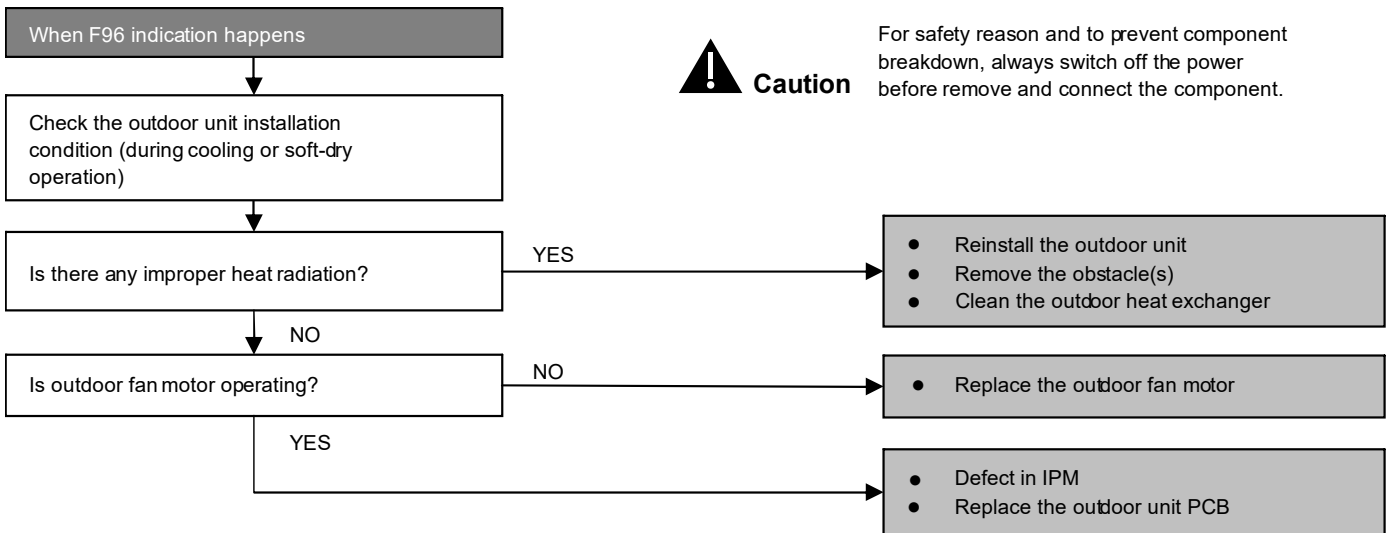

17.4.26 F97 (Compressor Overheating)

Malfunction Decision Conditions

- During operation of cooling and heating, when compressor tank temperature data (112°C) is detected by the compressor tank temperature sensor.

Malfunction Caused

- Faulty compressor tank temperature sensor
- 2/3 way valve closed
- Refrigerant shortage (refrigerant leakage)
- Faulty outdoor unit PCB
- Faulty compressor

Troubleshooting

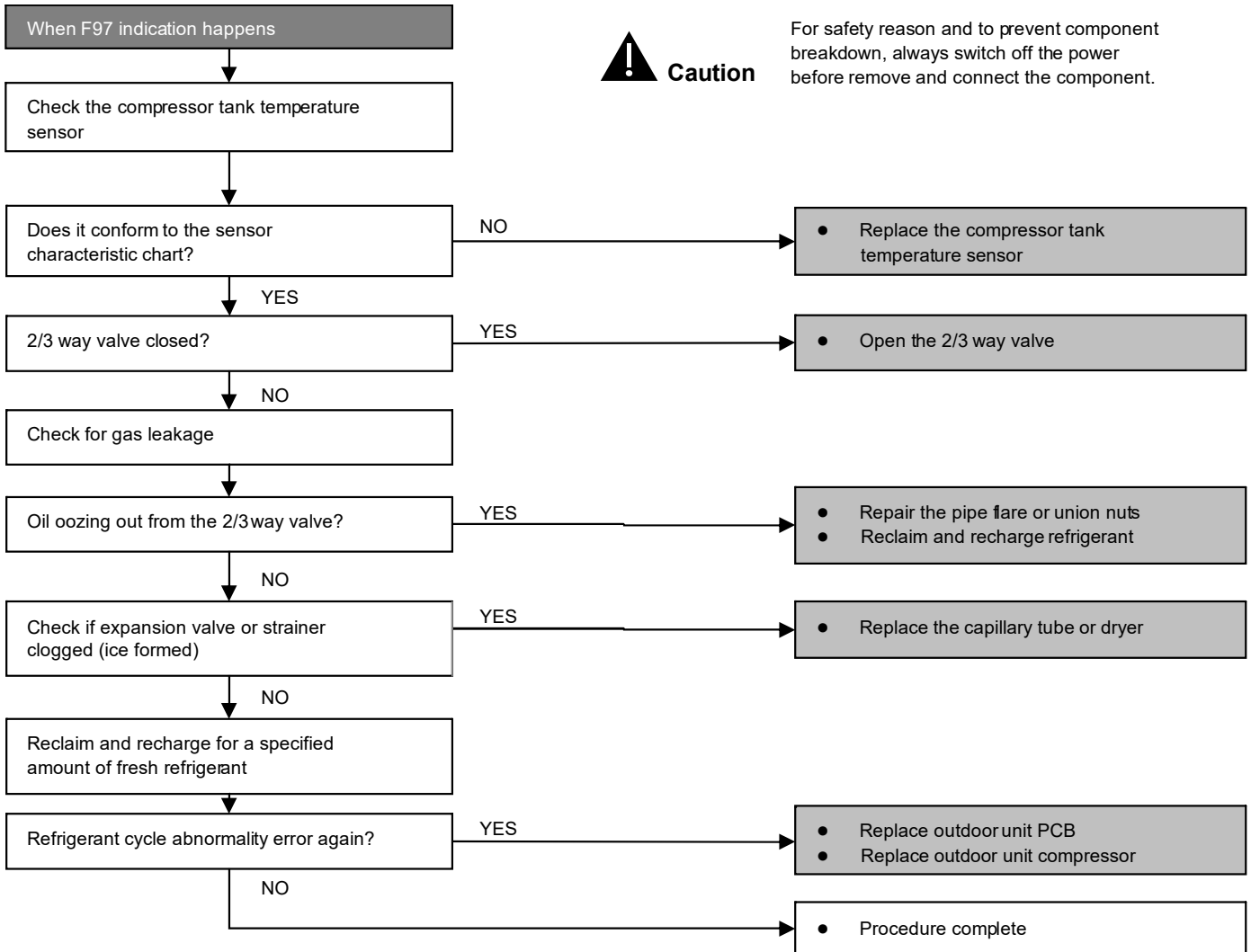

17.4.27 F98 (Input Over Current Detection)

Malfunction Decision Conditions

- During operation of cooling and heating, when an input over-current (X value in Total Running Current Control) is detected by checking the input current value being detected by current transformer (CT) with the compressor running.

Malfunction Caused

- Excessive refrigerant.
- Faulty outdoor unit PCB.

Troubleshooting

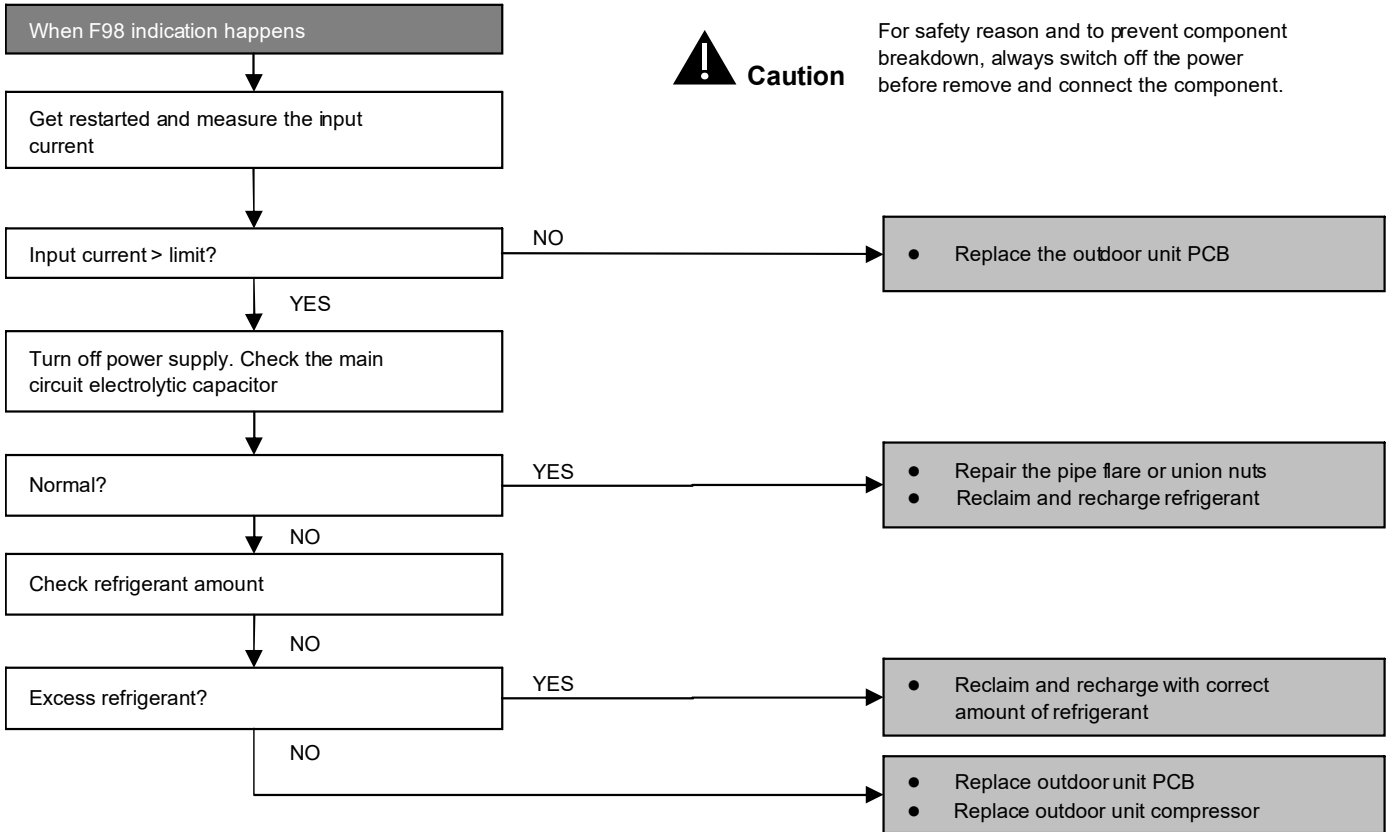

17.4.28 F99 (DC Peak Detection)

Malfunction Decision Conditions

During startup and operation of cooling and heating, when inverter DC peak data is received by the outdoor internal DC Peak sensing circuitry.

Malfunction Caused

- DC current peak due to compressor failure.
- DC current peak due to defective power transistor(s).
- DC current peak due to defective outdoor unit PCB.
- DC current peak due to short circuit.

Troubleshooting

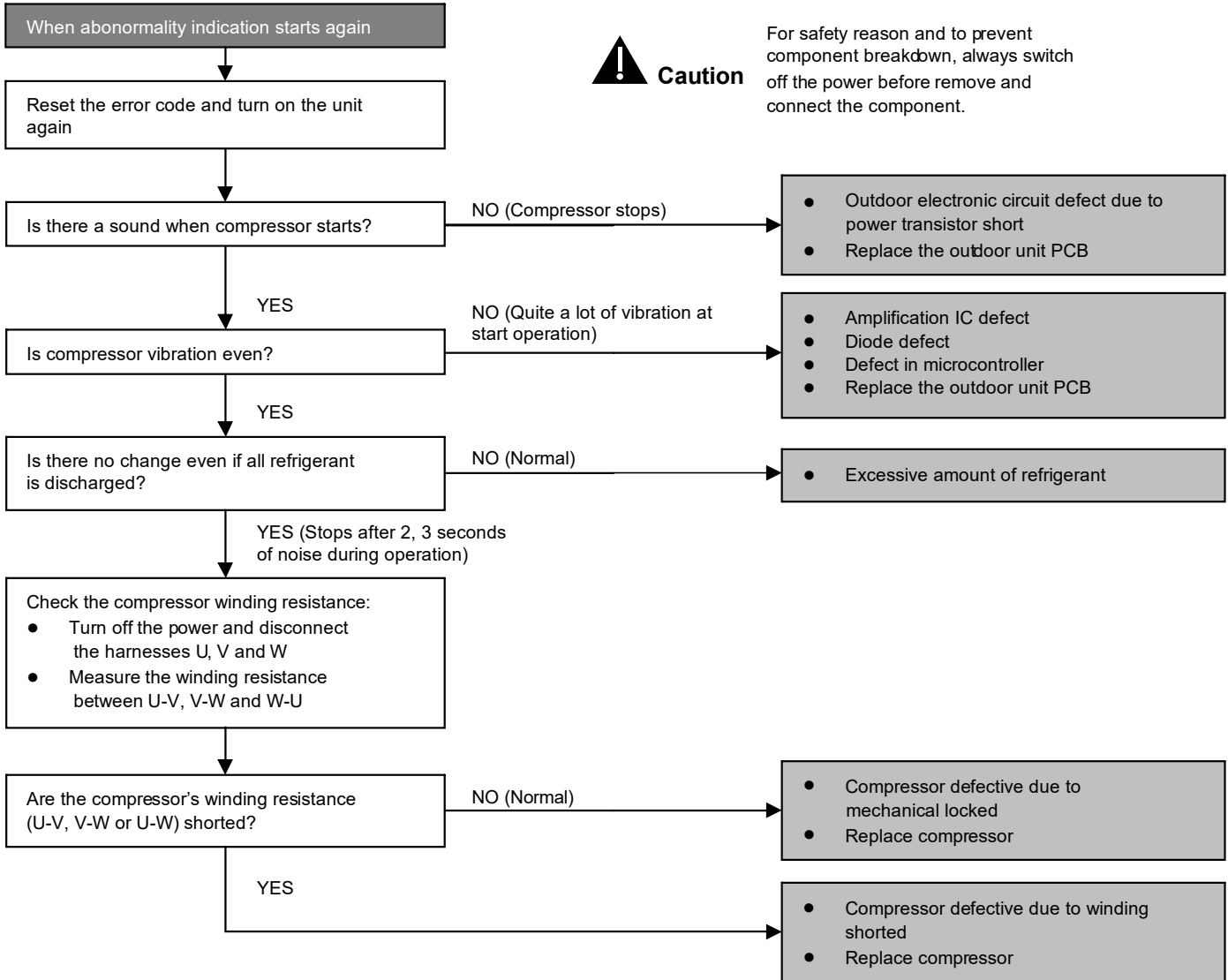

18. Disassembly and Assembly Instructions



WARNING

High Voltage is generated in the electrical parts area by the capacitor. Ensure that the capacitor has discharged sufficiently before proceeding with repair work. Failure to heed this caution may result in electric shocks.

18.1 Indoor Unit

18.1.1 Indoor Electronic Controllers, Cross Flow Fan and Indoor Fan Motor Removal Procedures

18.1.1.1 To Remove Front Grille

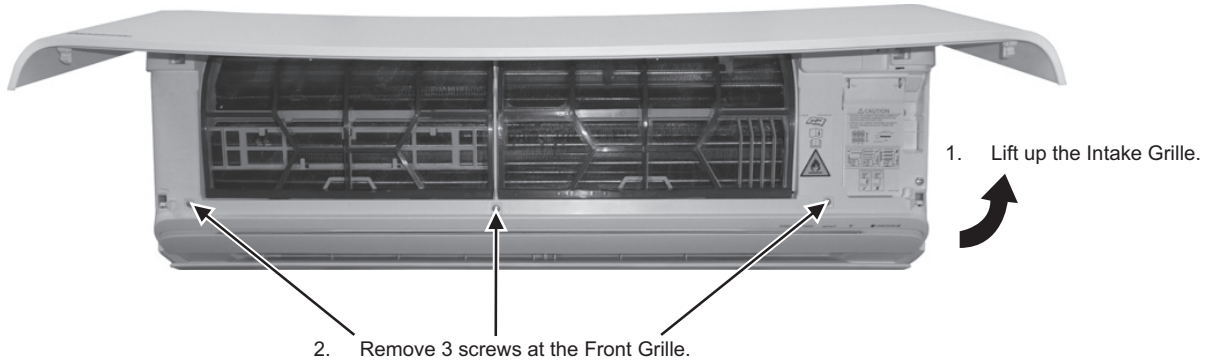

Figure 1

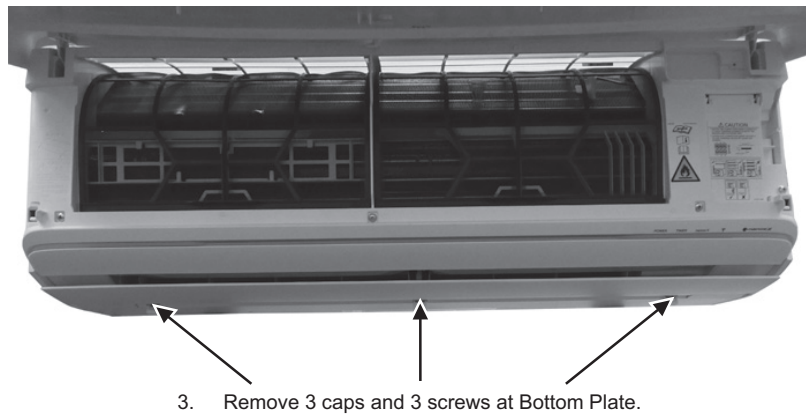

Figure 2



4. Detach the hook from left and right. Then remove the Bottom Plate.

Figure 3

5. Open the hooks on top of the Front Grille.

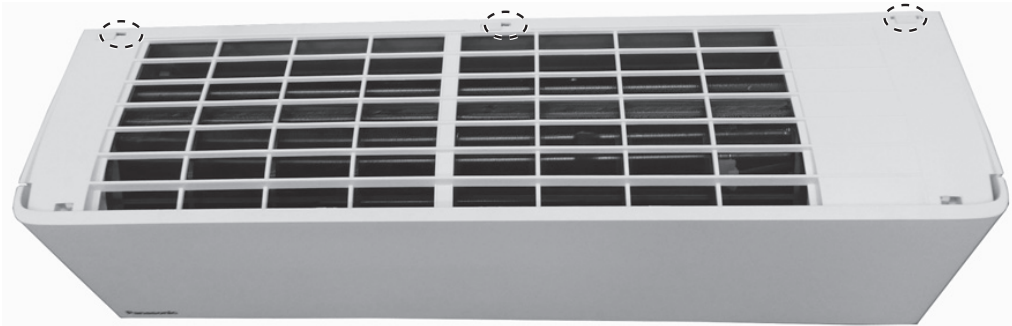

Figure 4



6. Remove the Front Grille.

Figure 5

18.1.1.2 To Remove Electronic Controller

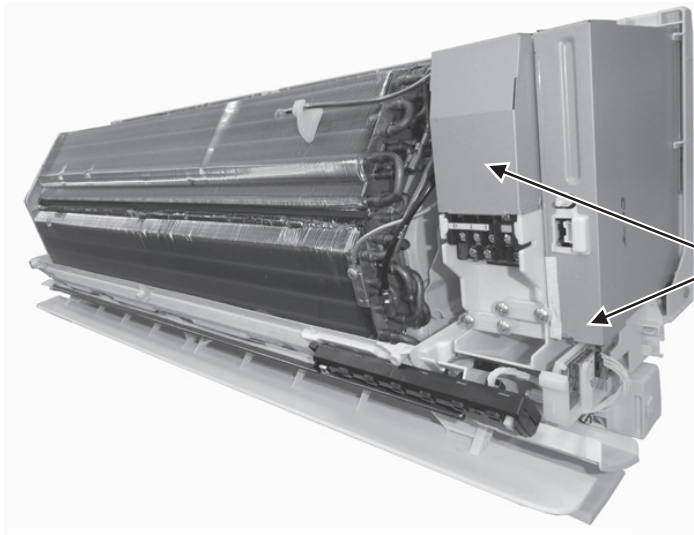

1. Remove the right side front cover first, then remove the second front cover.

Figure 6

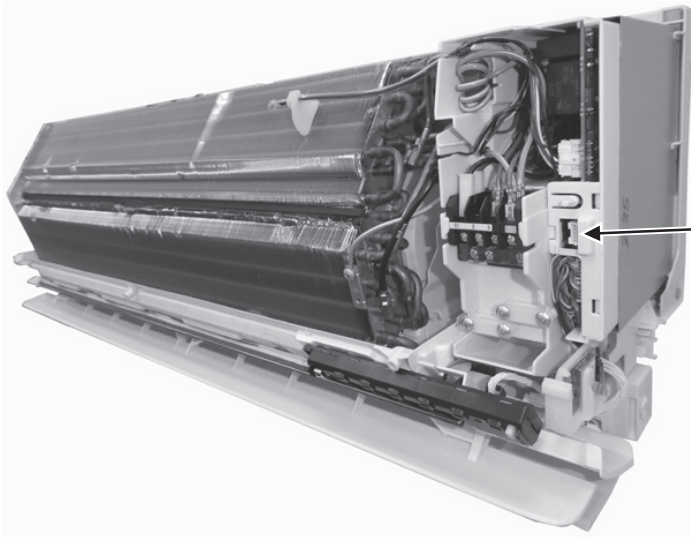

2. Remove the particular piece.

Figure 7

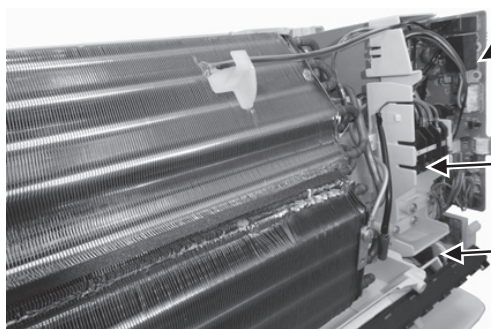

5. Pull out the Main Electronic Controller halfway. Then disconnect all connectors from the controller. Remove the Electronic controller.
3. Disconnect lead wire from the terminal board.
4. Disconnect CN-DISP connector from indicator complete.

Figure 8

18.1.1.3 To Remove Discharge Grille

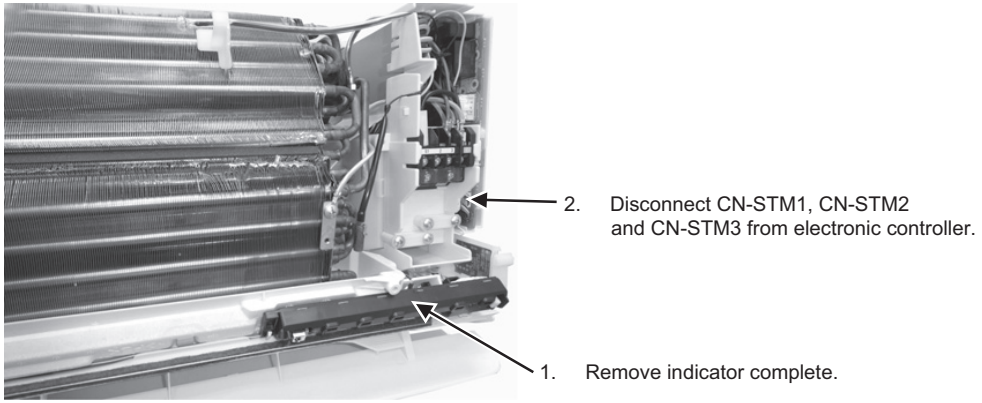

Figure 9

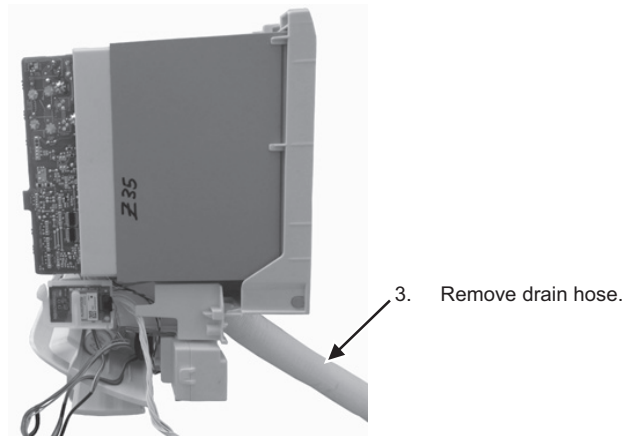

Figure 10

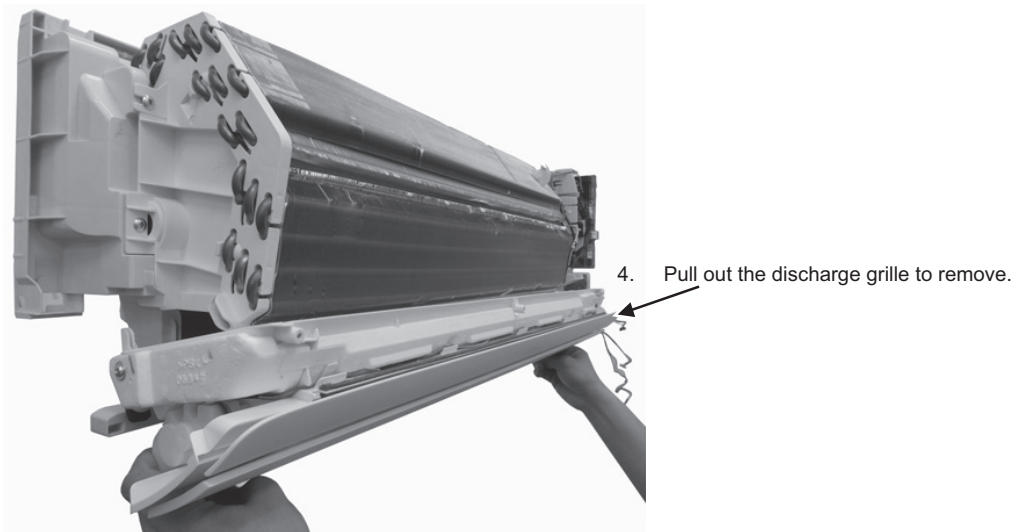

Figure 11

18.1.1.4 To Remove Cross Flow Fan

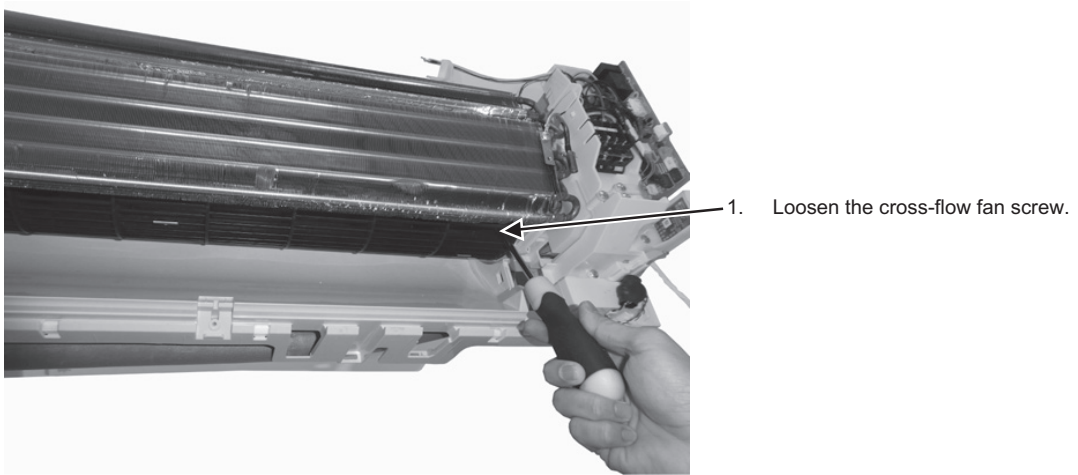

Figure 12

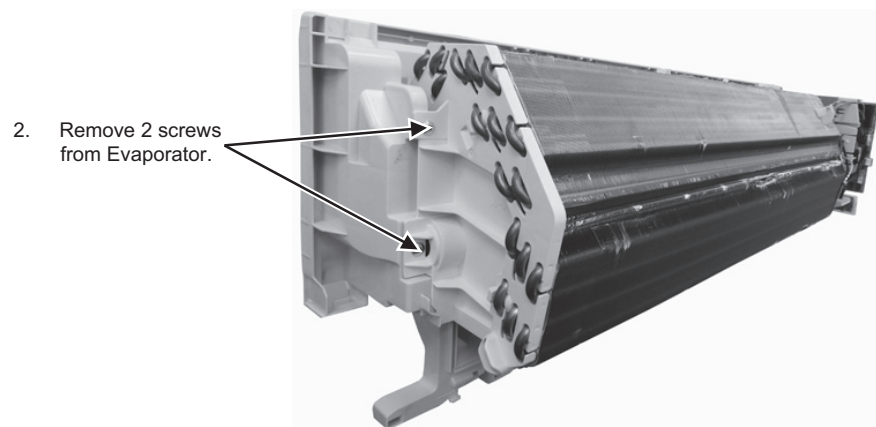

Figure 13

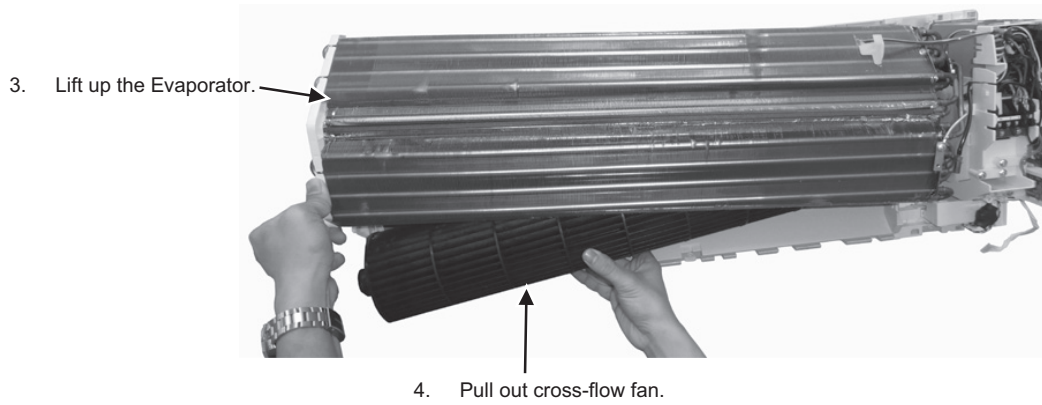
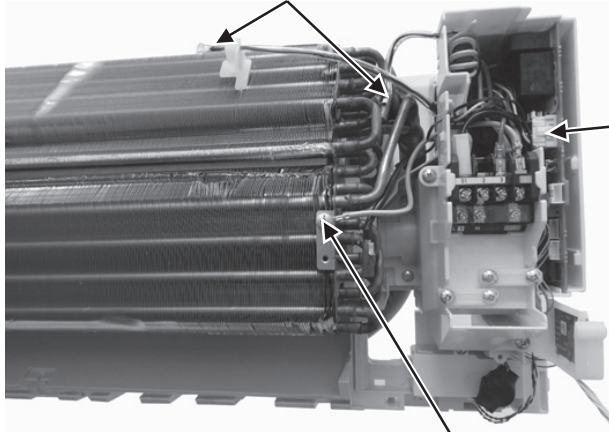

Figure 14

18.1.1.5 To Remove Fan Motor

3. Remove air temperature and pipe temperature sensor.



1. Disconnect CN-FM from electronic controller.

2. Remove earth wire from evaporator.

Figure 15

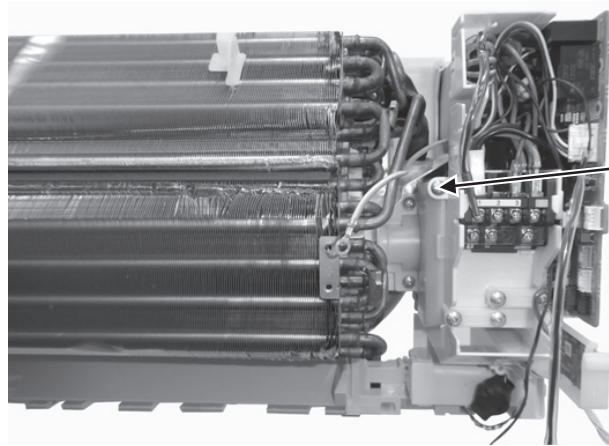

4. Remove 1 screw from control board complete. Then pull out the control board complete.

Figure 16

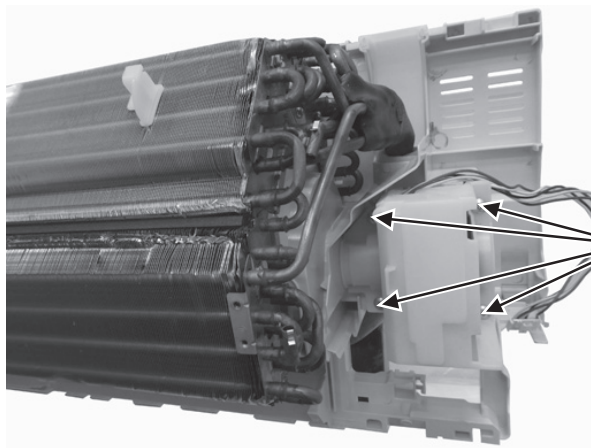

5. Remove 4 screws from fan motor cover.

Figure 17

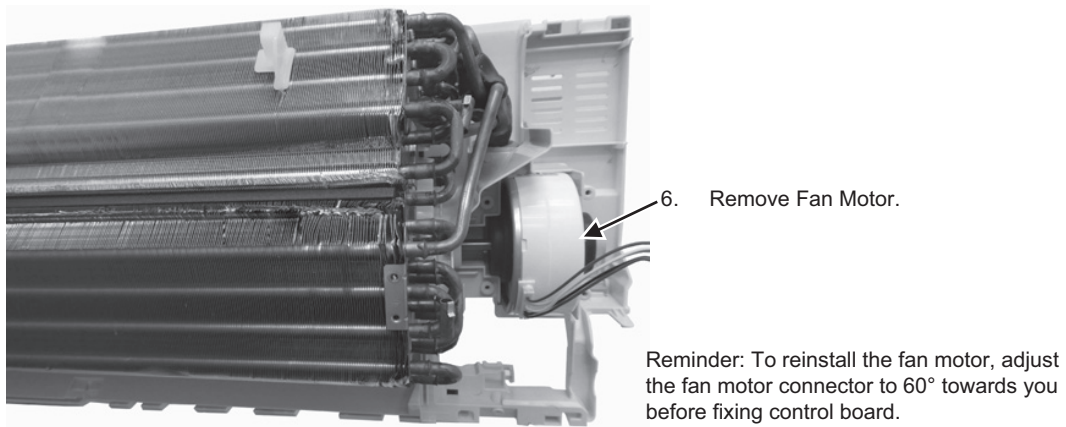

Figure 18

18.1.1.6 To Remove NanoeX

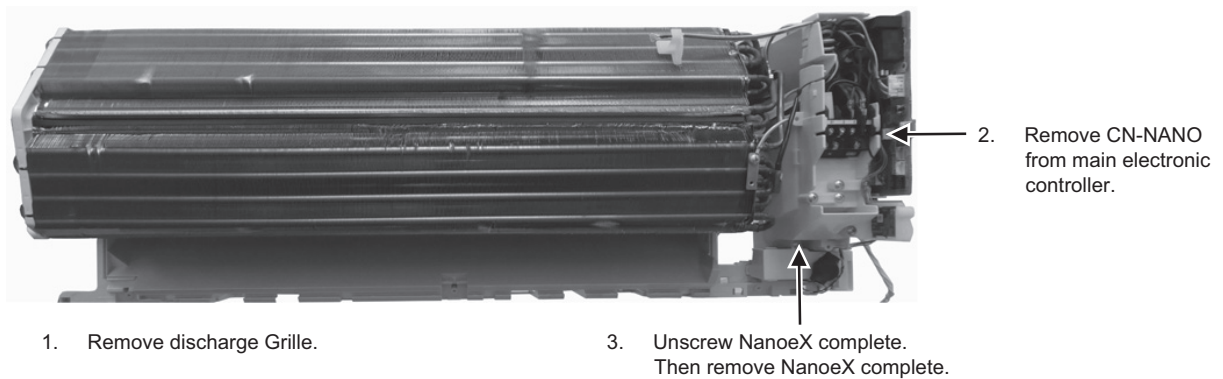
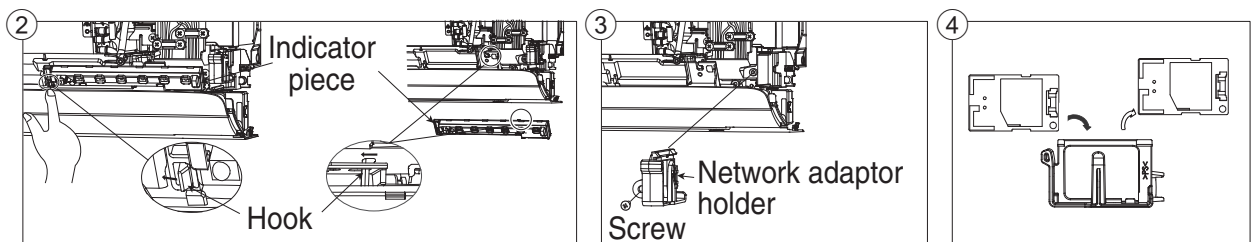

Figure 19

18.1.1.7 To Replace Wireless LAN Module (Network Adapter)

- 1 Remove the front grille (refer how to take out front grille) from the unit.
- 2 Remove the indicator piece by releasing the hook.
- 3 Remove 1 mounting screw, then remove the network adaptor holder.
- 4 After that, network adaptor can be easily replaced.



Reminder: Serviceman or owner must setting again Panasonic Comfort Cloud app after replace Wireless LAN Module.

18.2 Outdoor Electronic Controller Removal Procedure

 Caution! When handling electronic controller, be careful of electrostatic discharge.

1. Remove the 5 screws of the Top Plate. Lift up the left side of the Top Plate first, then remove the Top Plate.

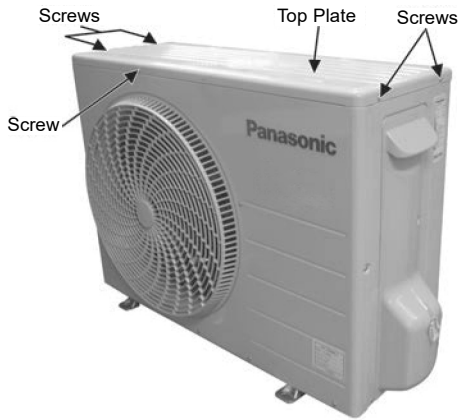

Fig. 1

2. Remove the 8 screws of the Cabinet Front Plate complete.

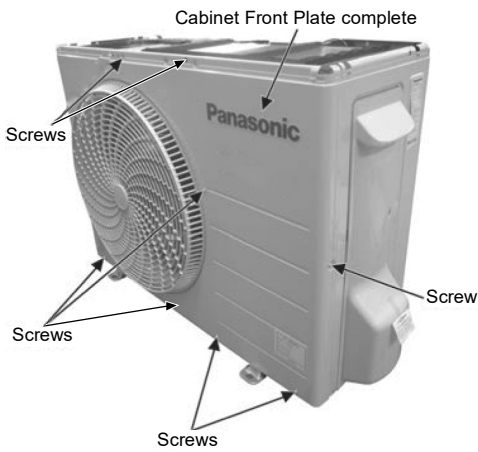

Fig. 2

3. Remove the screw of the Terminal Board Cover.
4. Remove the Top Cover of the Control Board by 4 hooks.

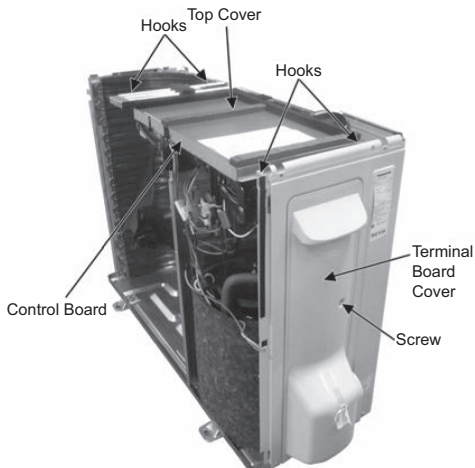

Fig. 3

5. Remove the Control Board as follows:

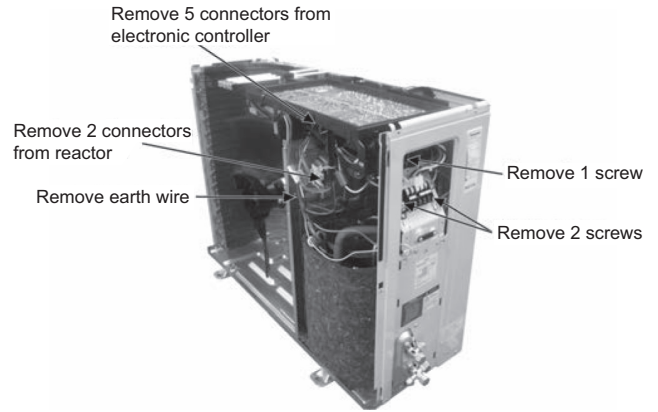

Fig. 4

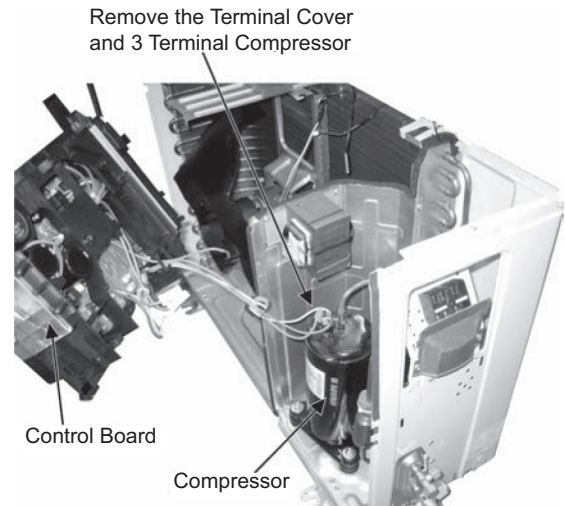

Fig. 5

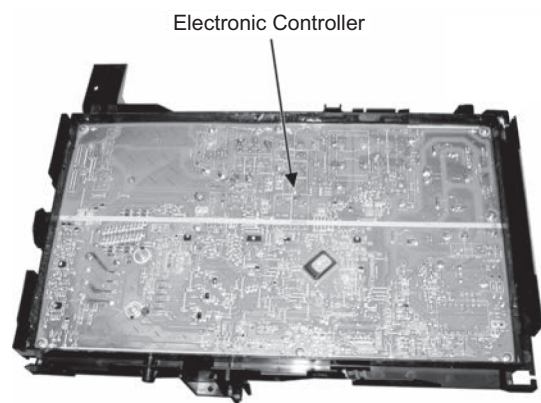

Fig. 6

18.3 Panasonic Comfort Cloud

18.3.1 Starting “Panasonic Comfort Cloud”

Create New Panasonic ID

Use “Panasonic Comfort Cloud” app as an option to control this product.

The screenshot shows the 'Login' screen of the Panasonic Comfort Cloud app. At the top, it says 'Login'. Below that, it asks the user to 'Please enter your Panasonic ID and password.' There are two input fields: 'Panasonic ID' and 'Password'. Below the input fields, there is a checkbox for 'Remember me', a link for 'Forgot ID/Password', and two links: 'Create new Panasonic ID' and 'View an example'. At the bottom, there is a 'Login' button.

- For new user, select “Create new Panasonic ID” to register.
- For registered user, log in using your Panasonic ID and password.

18.3.2 App Setting

Add new air conditioner

- Before using the “Panasonic Comfort Cloud” app, you need to register this product.

The sequence of screenshots shows the process of adding a new air conditioner:

- Step 1:** The 'Home' screen shows a room named 'Bedroom 1' with a temperature of 30.0°C and a power icon. A dashed box with a plus sign indicates where to click to add a new device.
- Step 2:** The 'Add new device' screen asks 'Which appliances do you want to add?' with three options: 'Air conditioner', 'Air to water heat pump', and 'Commercial air conditioner'. The 'Air conditioner' option is highlighted with a dashed box.
- Step 3:** The 'Add new air conditioner' screen asks 'Please choose the following:' with two options: 'Built-in wireless module' and 'External wireless adaptor'. The 'Built-in wireless module' option is highlighted with a dashed box.
- Step 4:** The 'Add new air conditioner' screen provides instructions: 'Follow the guide to set up Wireless LAN of the air-conditioner.' and lists two steps: '1. Connect air-conditioner to the server via wireless LAN router.' and '2. Use smartphone to register air-conditioner to the server.' The 'Start' button is highlighted with a dashed box.
- Step 5:** The 'Add new air conditioner' screen asks 'Please choose the following:' with two options: 'Newly purchased air-conditioner' and 'Others (Air-conditioner used before)'. The 'Newly purchased air-conditioner' option is highlighted with a dashed box.

Setting connection network

- ① Check that the Wireless LAN LED is ON. Point the remote control to the air conditioner and press the Wireless LAN  button until the Wireless LAN LED starts blinking.

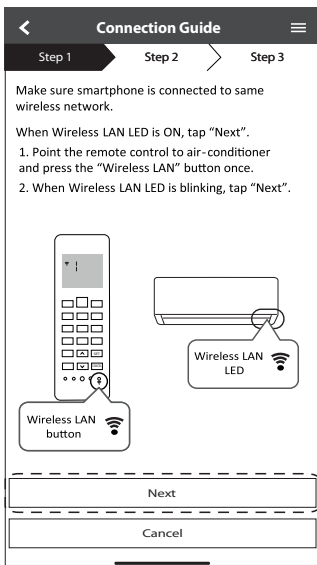

Fast blink	The unit is establishing the connection.
Slow blink	The unit is not securing the connection.
No blink (stays on)	The unit has established the connection.

- It can establish the connection to the unit even if the unit is turned OFF.

Note

- If the Wireless LAN LED blinks continuously and you do not want to use the app, press the Wireless LAN  button to turn it off.

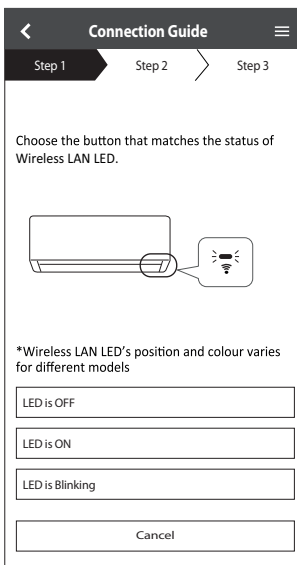

- ② Select the status of the Wireless LAN LED.

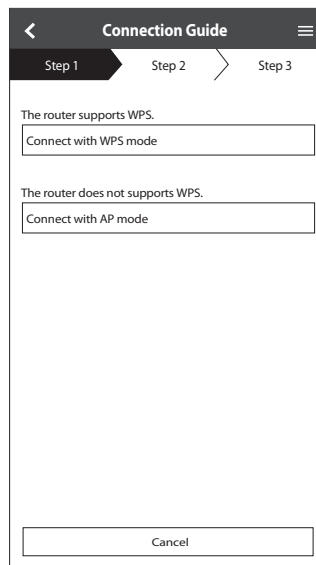

- ③ Select the preferred connection setup mode.



Connection network using WPS mode (method 1)

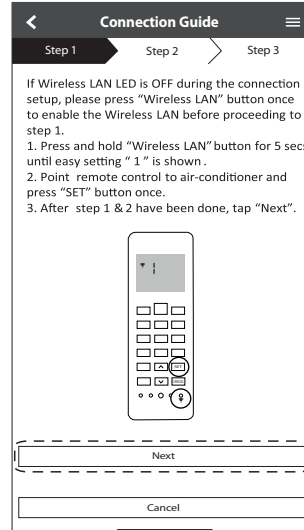
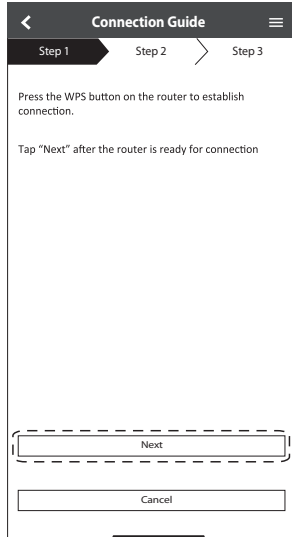

- ① Press the WPS button on the router that will be connected to the air conditioner.
 - Check that the Wireless LAN LED is ON. If the Wireless LAN LED is OFF, press the Wireless LAN  button to turn it on, and enable Wireless LAN connection.
- ② Check that the Wireless LAN LED is ON. Press the Wireless LAN  button for 5 seconds until "1" appears on the remote control. Point the remote control to the air conditioner and press .

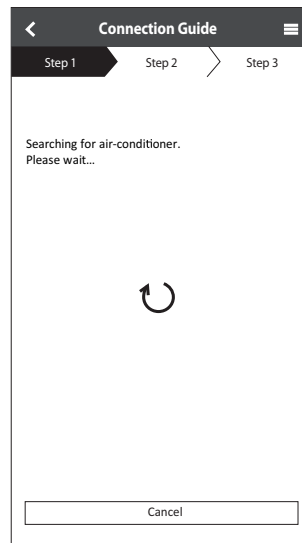
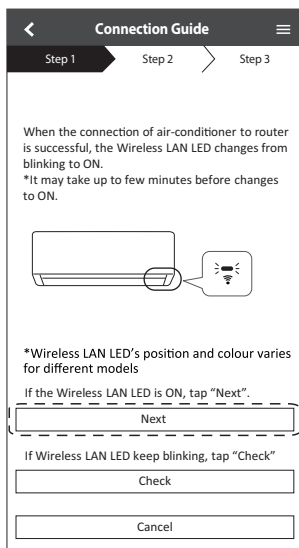

- ③ When the air conditioner is successfully connected to the router, the Wireless LAN LED stops blinking and turns ON.
- ④ If the Wireless LAN LED keeps blinking, check the wireless router connection.



Connection network using AP mode (method 2) (For Android 5.0 and above & iOS 11 and above only)

- 1 Check that the Wireless LAN LED is ON. Press the Wireless LAN  button for 5 seconds until “1” appears on the remote control.
Press  until “2” appears. Point the remote control to the air conditioner and press .
Join to connect to the “Panasonic-CS-wirelessAP” network.

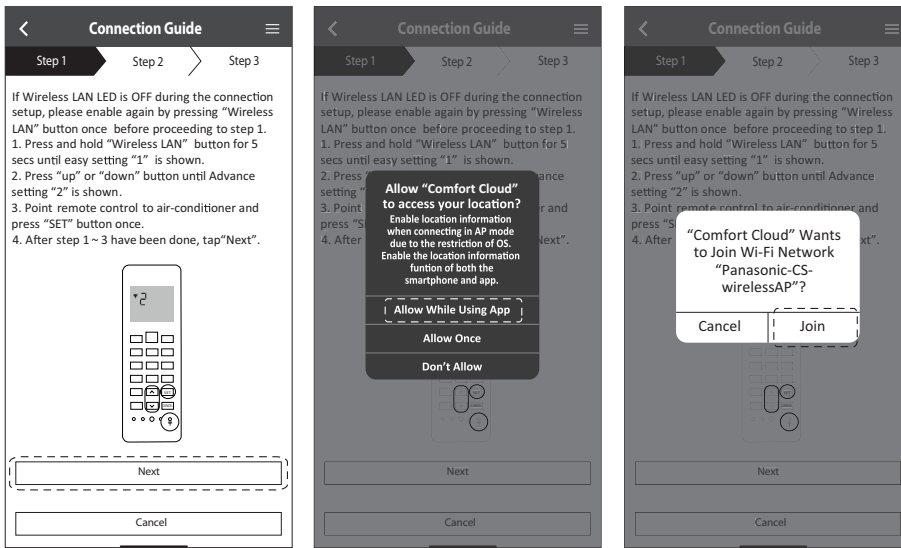

- 2 Enter the password of the selected wireless router and continue.

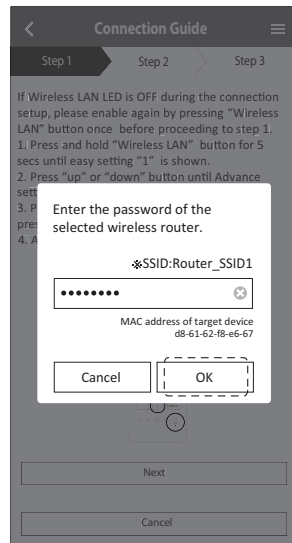

- ③ When the air conditioner is connected to the router successfully, the Wireless LAN LED stops blinking and turns ON. When the Wireless LAN LED is ON, connect your smartphone to the wireless router to continue the setup.
- If the Wireless LAN LED keeps blinking, check the wireless router connection.

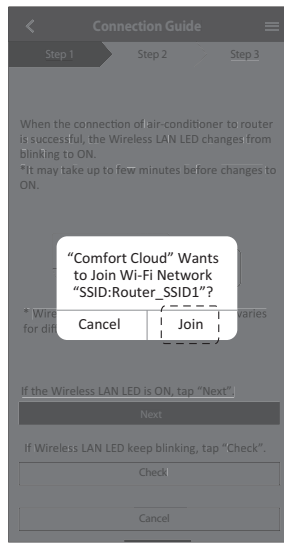
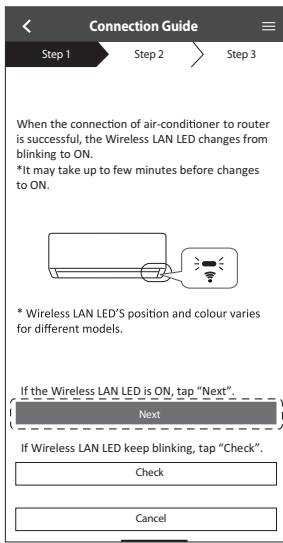

Select the air-conditioner and set the password

- ① Select the model to register your air-conditioner.

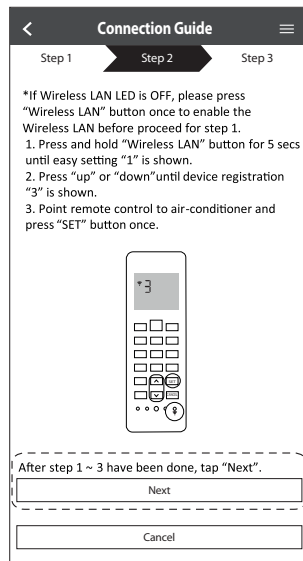
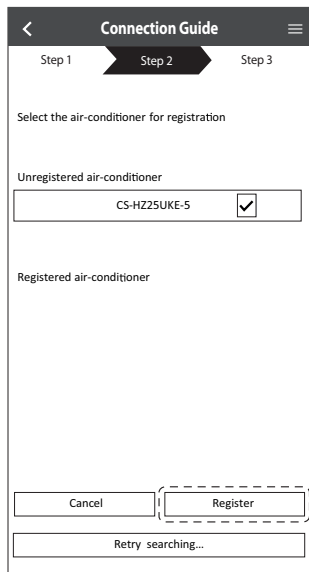

- ② Set a password to complete the registration. The password must be 8-15 characters with letters and numbers.

Note

- Keep the password for future use. You can use the same password when you register other Panasonic devices.

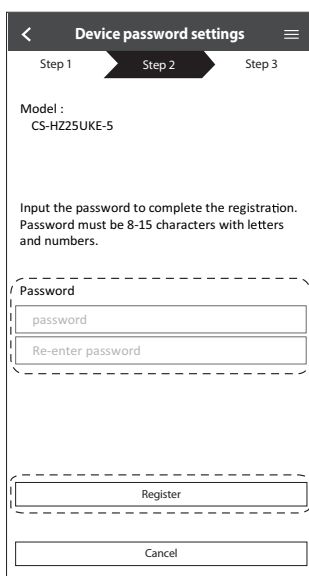

Registration completed

- ① After registration and connection is established between the app and your air conditioner, set the preferred name to identify your air conditioner easily.
 - After registering your preferred name for your air conditioner, you can use the “Panasonic Comfort Cloud” app functions.
- ② Beside operation control, this application can monitor the estimated energy consumption and do comparison for different time frame by referring to the statistic's graph.

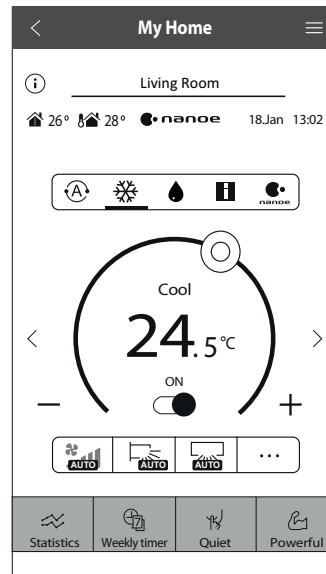
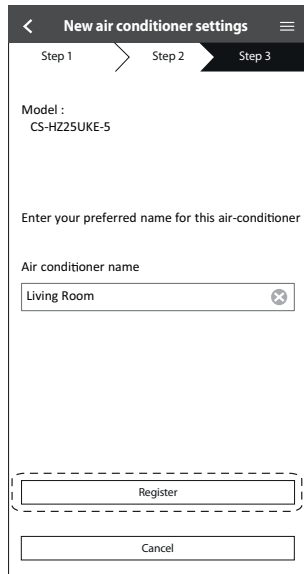

Note

- Check the app's connectivity status before and during operation. If the status is not reflected, use the remote control to operate your air conditioner.

18.3.3 Launch the App

- ① Log in to the “Panasonic Comfort Cloud” app.
- ② Select your air conditioner to control.

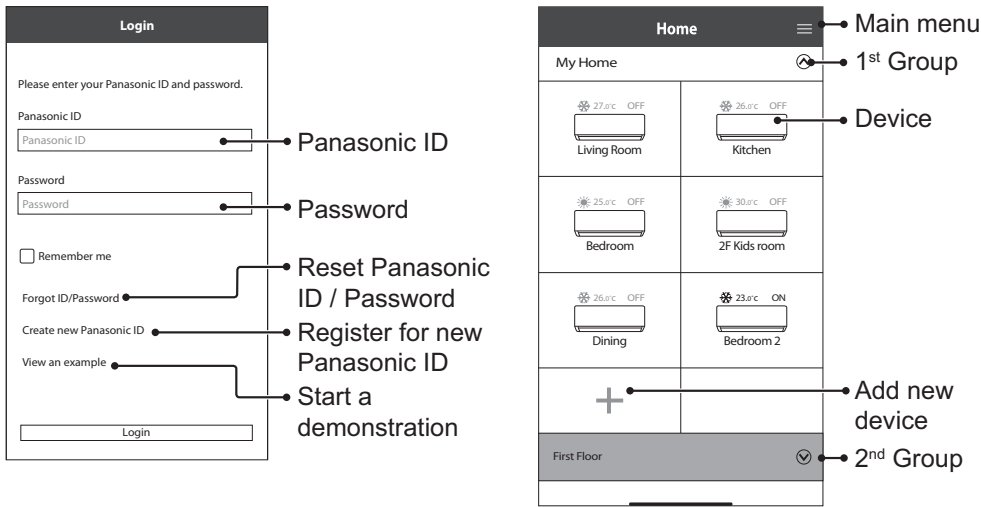

Main Device Screen - Operation Setting

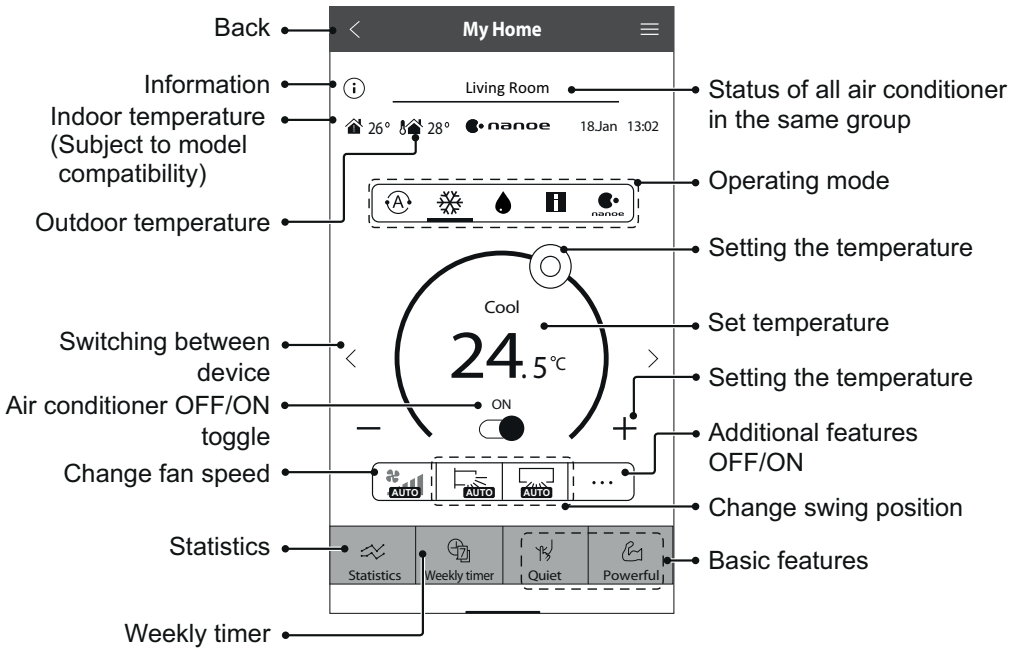

Information

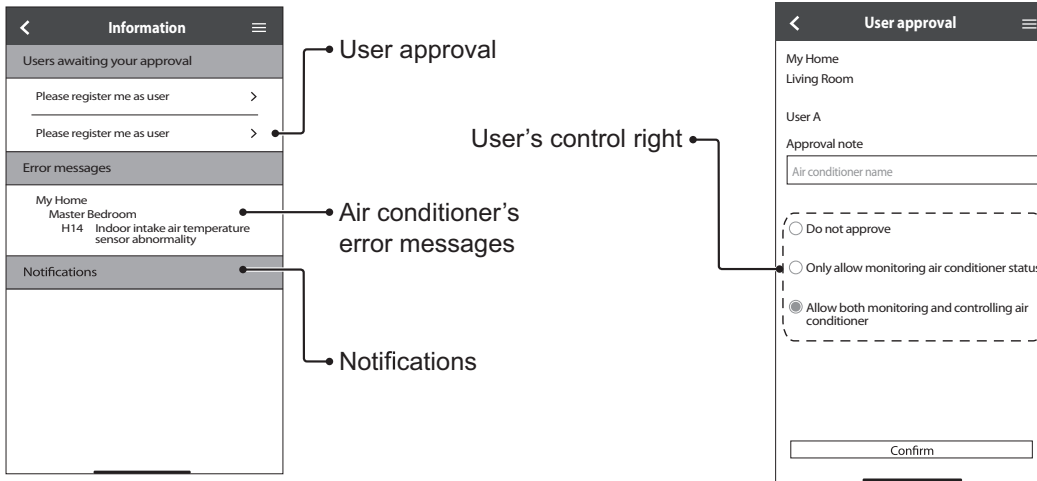

Air Conditioner Status

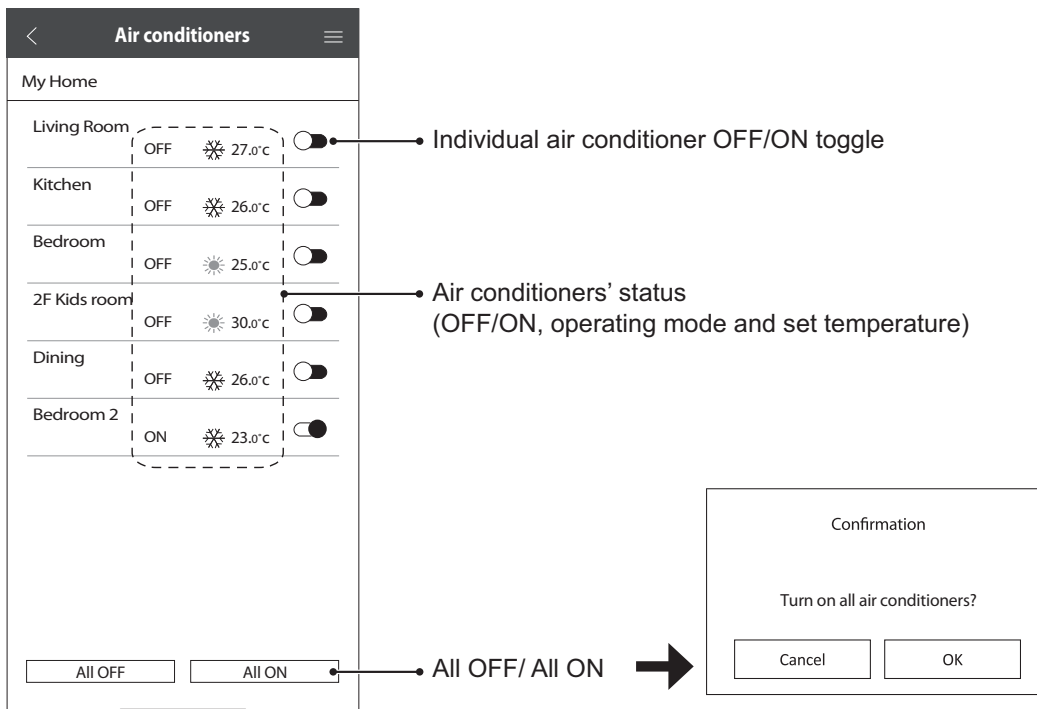

Statistics

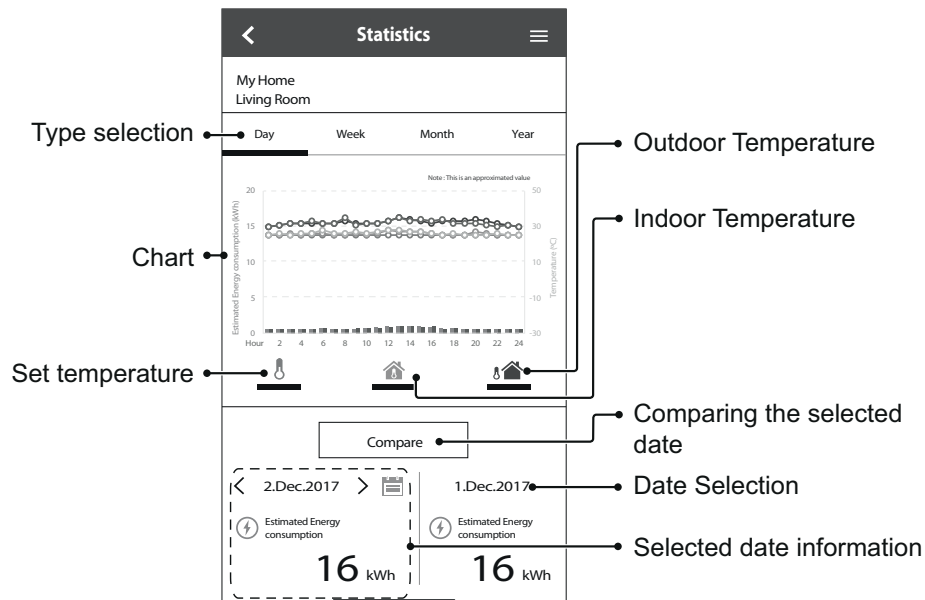

Note

- Estimated energy consumption may not be supported by certain models.
- For Multi-split AC system: energy consumption value displayed is for whole system.

Weekly Timer

Weekly Timer

① Tap “Weekly timer” to set the timer schedule.

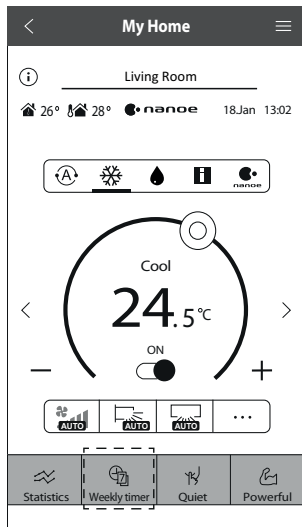

② Tap .

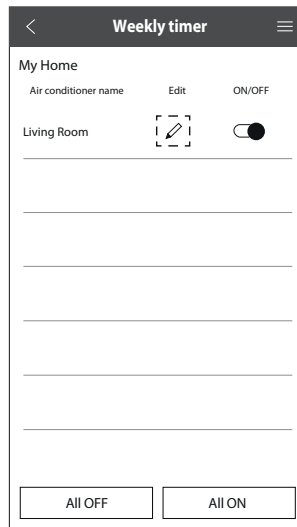

③ Tap  to add a new program. You can set a maximum of six programs for one day.

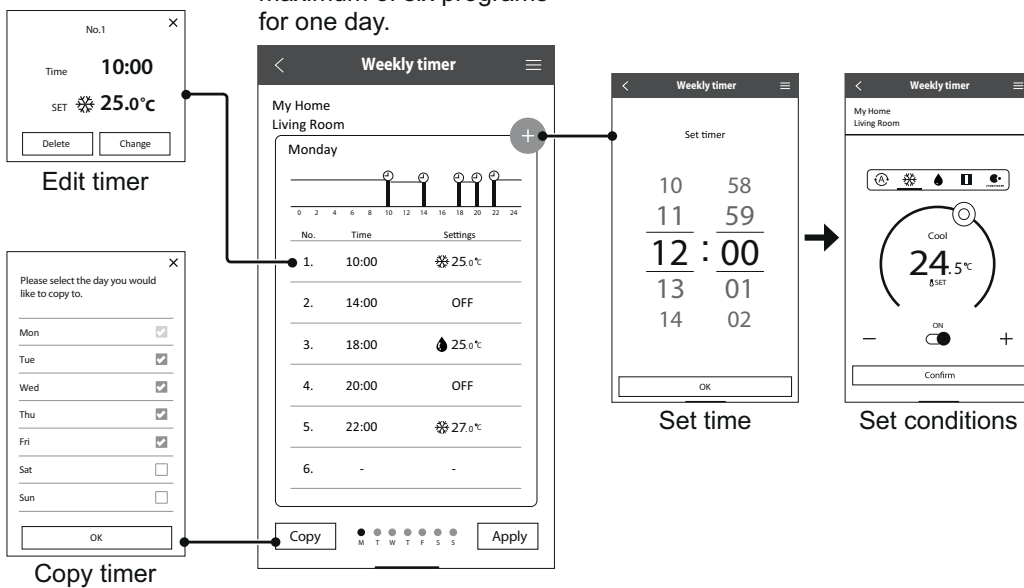

Main Menu

The main menu allows user to edit the device settings and provides important information.

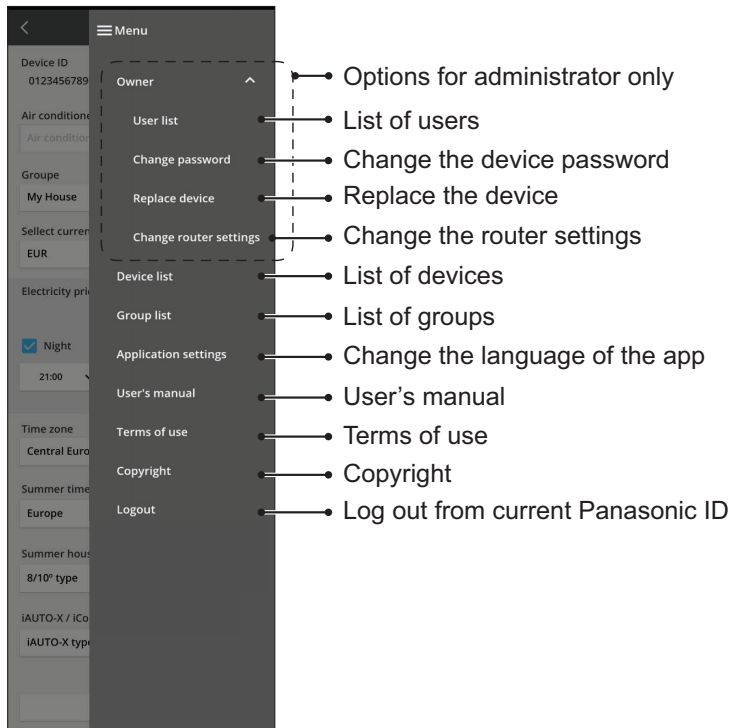

User List

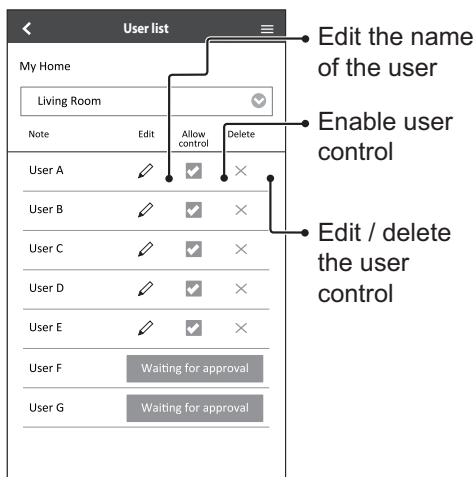

Change the Device Password

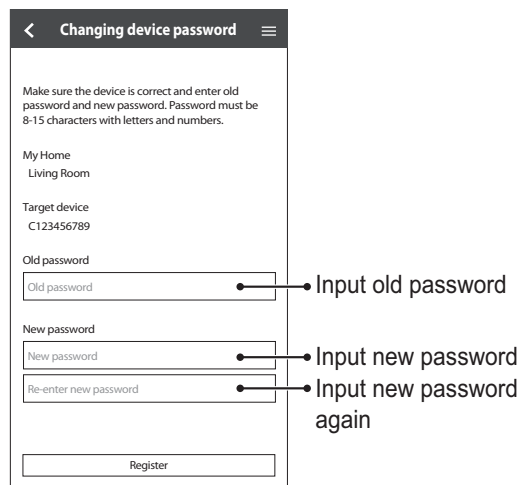

Replace the Device

① Select "Replace device" from the menu.

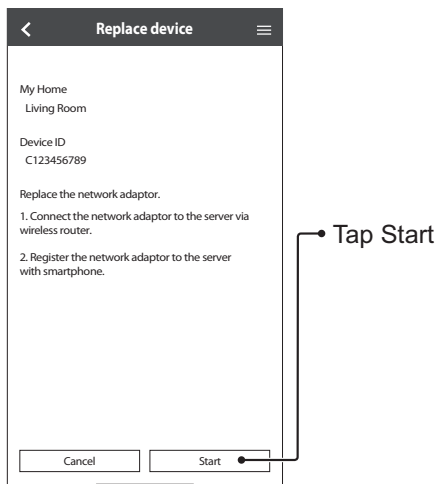

Change the Router Settings

② Select "Change router settings" from the menu.

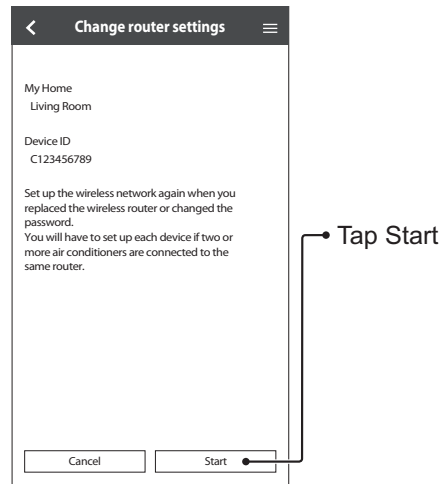

Device List

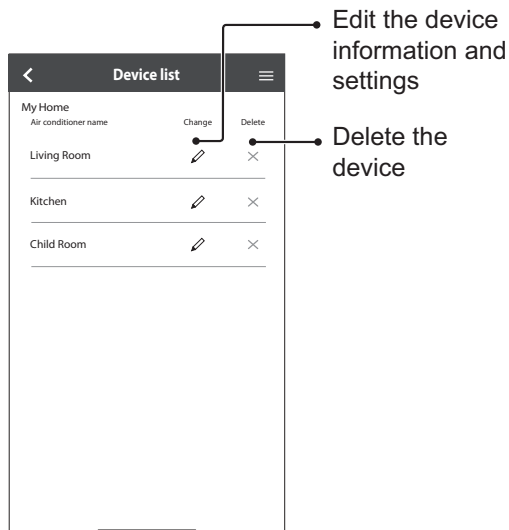

Group List

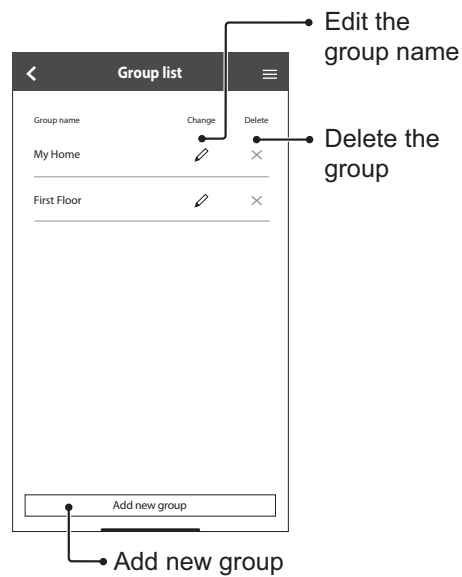

19. Technical Data

Technical data provided are based on the air conditioner running under free frequency.

19.1 Cool Mode Performance Data

Unit setting: Standard piping length, Hi Fan, Cool mode at 16.0°C

Voltage: 230V

19.1.1 CS-HZ25XKE CU-HZ25XKE / CS-HZ25XKE-5 CU-HZ25XKE-5

Indoor (°C)		Outdoor DB (°C)								
DB	WB	16			25			35		
		TC	SHC	IP	TC	SHC	IP	TC	SHC	IP
27	19.0	3041	2736	259	2955	2720	350	2500	2457	455
	22.0	3418	2111	246	3226	2004	348	2857	1875	452
23	15.7	2784	2665	271	2617	2587	357	2351	2304	450
	18.4	3139	2060	264	2885	1999	352	2498	1815	450
20	13.3	2618	2557	277	2391	2343	356	2163	2119	450
	15.8	2880	2056	271	2614	1931	354	2327	1778	451

(Dry bulb value based on 46% humidity)

19.1.2 CS-HZ35XKE CU-HZ35XKE

Indoor (°C)		Outdoor DB (°C)								
DB	WB	16			25			35		
		TC	SHC	IP	TC	SHC	IP	TC	SHC	IP
27	19.0	4348	3596	455	4226	3576	615	3500	3230	800
	22.0	4888	2775	432	4613	2635	611	4086	2465	796
23	15.7	3982	3503	476	3742	3401	628	3362	3188	792
	18.4	4489	2708	464	4125	2628	619	3573	2386	791
20	13.3	3744	3361	487	3419	3226	627	3092	3071	792
	15.8	4118	2703	477	3738	2539	623	3328	2338	792

(Dry bulb value based on 46% humidity)

TC - Total Cooling Capacity (W)
 SHC - Sensible Heat Capacity (W)
 IP - Input Power (W)

19.2 Heat Mode Performance Data

Unit setting: Standard piping length, Hi Fan, Heat mode at 30.0°C

Voltage: 230V

19.2.1 CS-HZ25XKE CU-HZ25XKE / CS-HZ25XKE-5 CU-HZ25XKE-5

Indoor (°C)	Outdoor WB (°C)													
	-25/-26		-20/-21		-15/-16		-7/-8		2/1		7/6		12/11	
DB	TC	IP	TC	IP	TC	IP	TC	IP	TC	IP	TC	IP	TC	IP
24	3477	1624	3921	1827	4650	2001	4538	1932	5046	1910	6858	2153	7282	2150
20	3600	1620	4200	1750	4780	1880	5000	1940	5430	1910	7500	2160	7867	2131
16	3627	1520	4364	1693	4838	1742	4998	1830	5557	1912	7813	2152	8235	2143

19.2.2 CS-HZ35XKE CU-HZ35XKE

Indoor (°C)	Outdoor WB (°C)													
	-25/-26		-20/-21		-15/-16		-7/-8		2/1		7/6		12/11	
DB	TC	IP	TC	IP	TC	IP	TC	IP	TC	IP	TC	IP	TC	IP
24	3573	1685	4014	1900	4863	2108	4647	1992	5316	1990	7224	2243	7671	2240
20	3700	1680	4300	1820	5000	1980	5120	2000	5720	1990	7900	2250	8286	2220
16	3728	1576	4468	1761	5061	1835	5118	1887	5854	1992	8229	2242	8675	2232

TC - Total Cooling Capacity (W)

IP - Input Power (W)

20. Service Data

Service data provided are based on the air conditioner running under rated frequency during forced cooling / forced heating mode.

20.1 Cool Mode Outdoor Air Temperature Characteristic

Condition

- Room Temperature: 27/19°C, Cooling Characteristic
- Fan: High
- Piping Length: 5.0 m
- Freq: Rated Fc

20.1.1 CS-HZ25XKE CU-HZ25XKE / CS-HZ25XKE-5 CU-HZ25XKE-5

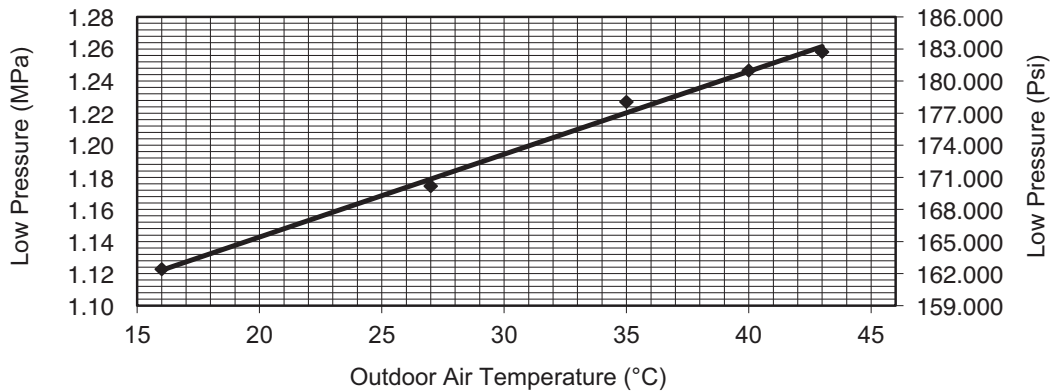
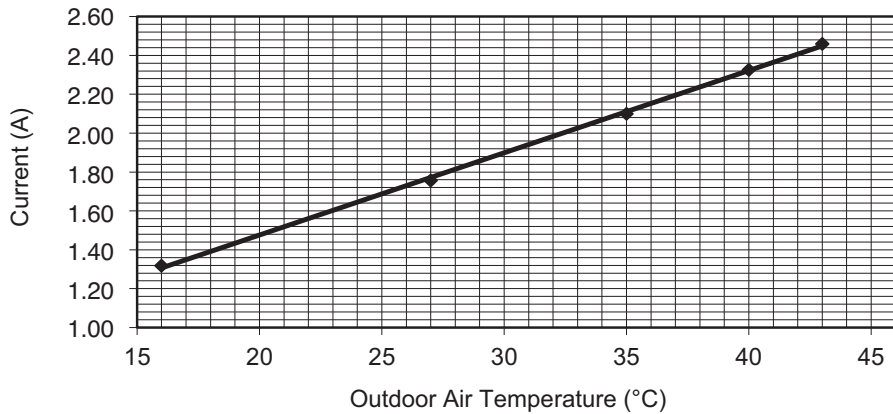
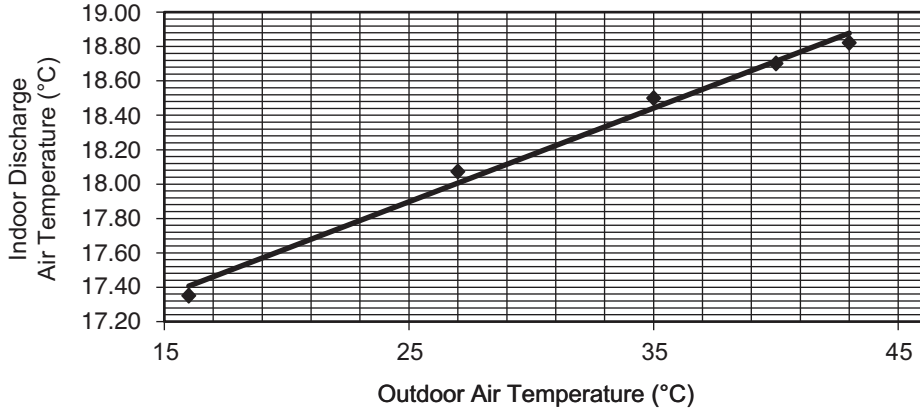

20.1.2 CS-HZ35XKE CU-HZ35XKE

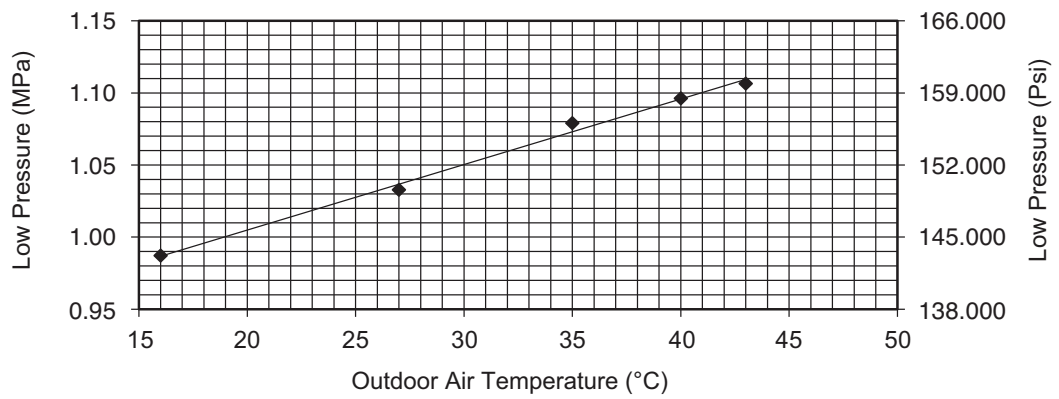
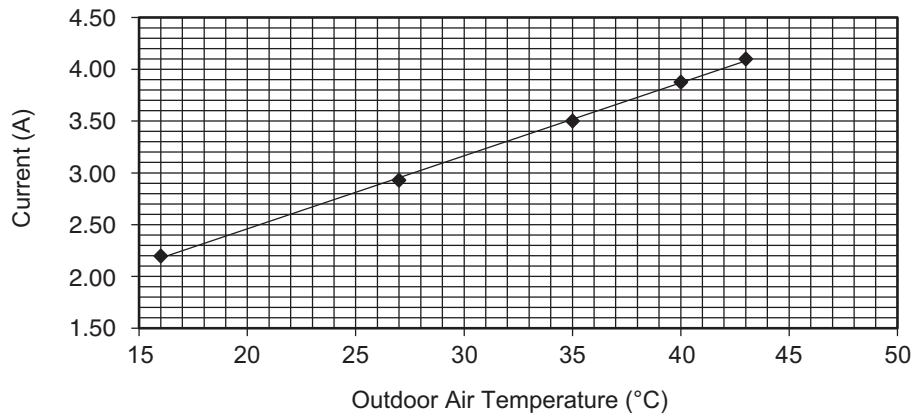
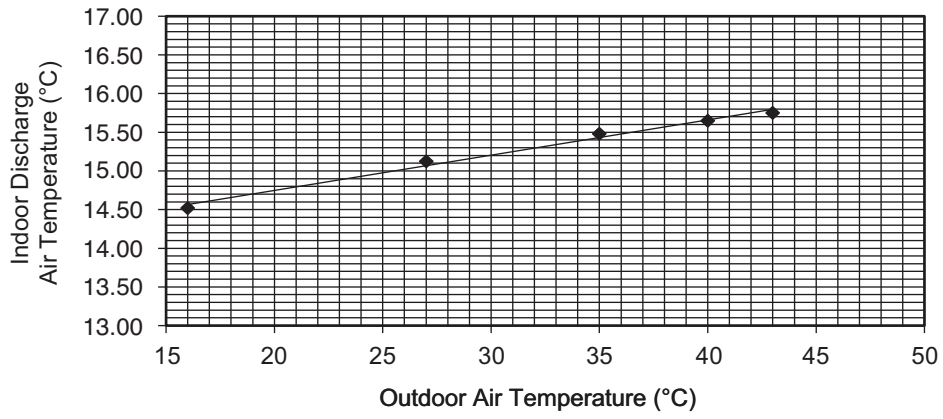

20.2 Heat Mode Outdoor Air Temperature Characteristic

Condition

- Room Temperature: 20°C, Heating Characteristic
- Fan: High
- Piping Length: 5.0 m
- Freq: Rated Fh

20.2.1 CS-HZ25XKE CU-HZ25XKE / CS-HZ25XKE-5 CU-HZ25XKE-5

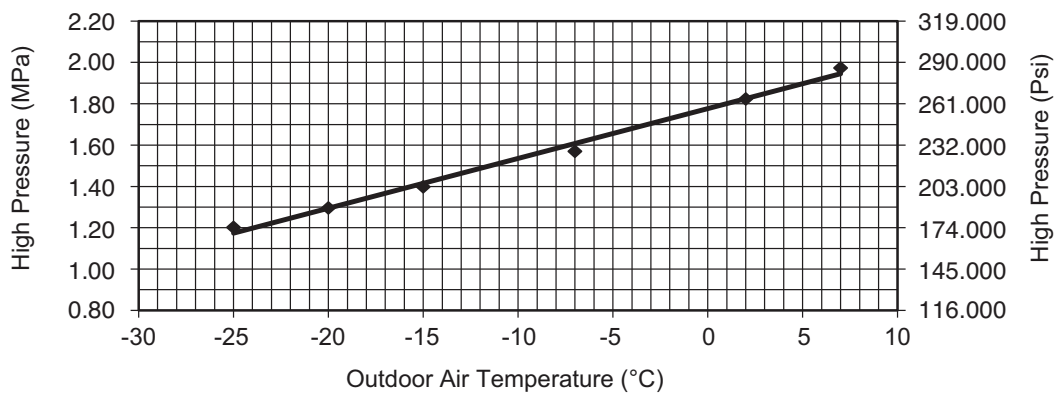
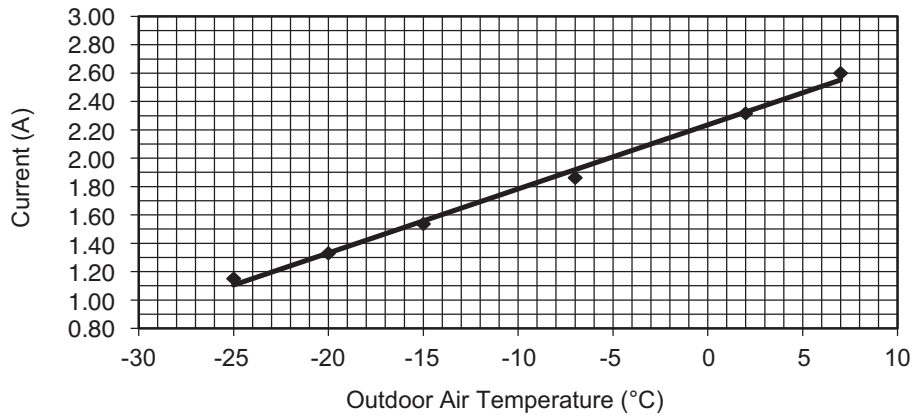
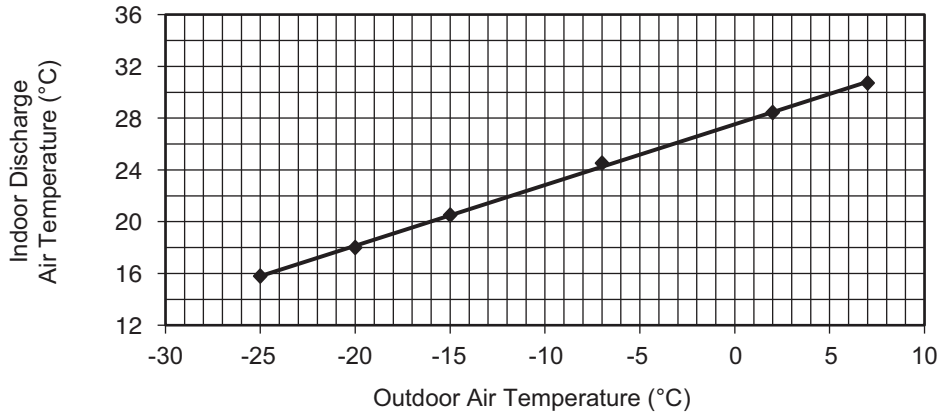

20.2.2 CS-HZ35XKE CU-HZ35XKE

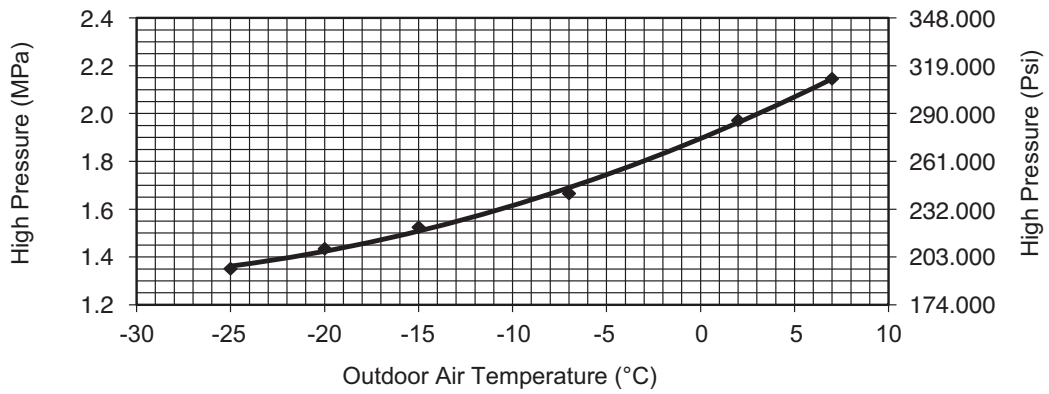
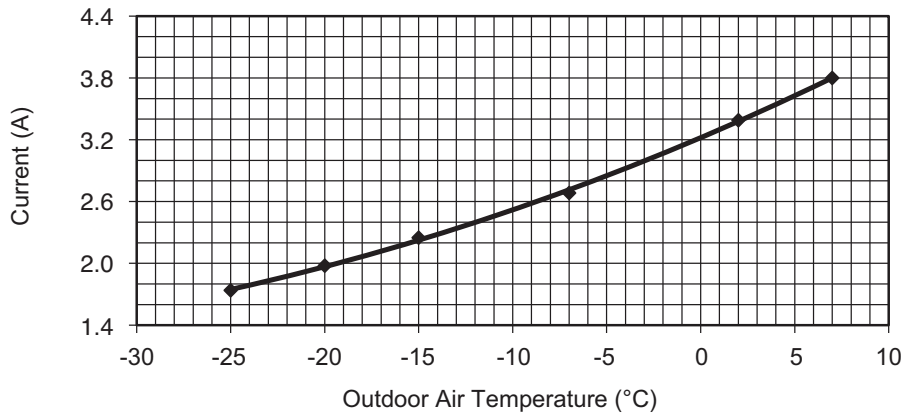
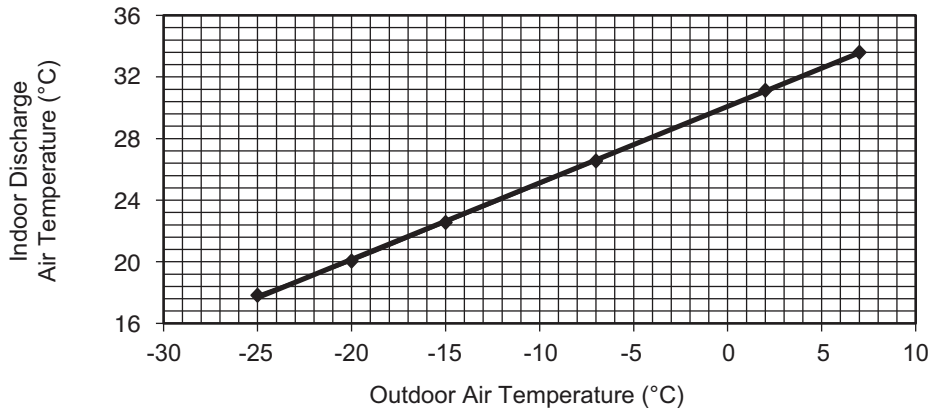

20.3 Piping Length Correction Factor

The characteristic of the unit has to be corrected in accordance with the piping length.

20.3.1 Cooling Capacity

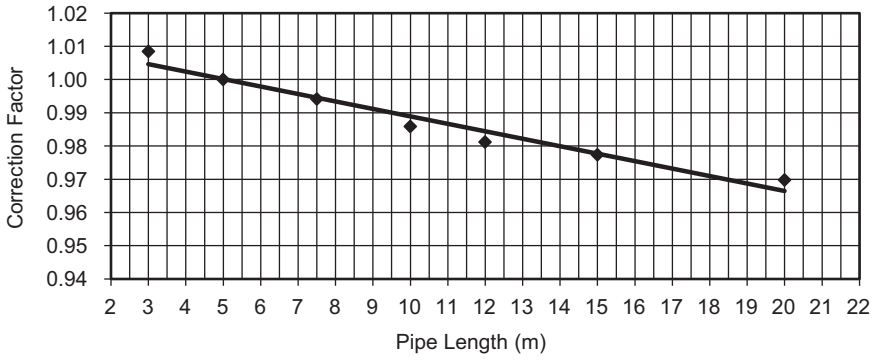

3	1.0084
5	1.0000
7.5	0.9941
10	0.9859
12	0.9812
15	0.9773
20	0.9698

20.3.2 Heating Capacity

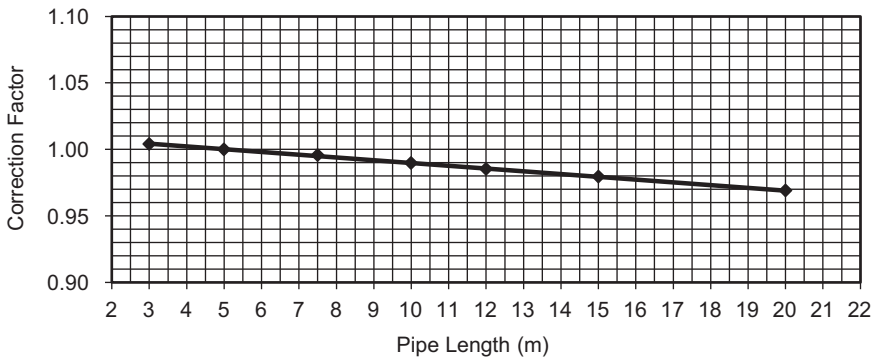

3	1.0041
5	1.0000
7.5	0.9956
10	0.9897
12	0.9853
15	0.9795
20	0.9690

Note: The graphs show the factor after added right amount of additional refrigerant

21. Exploded View and Replacement Parts List

21.1 Indoor Unit

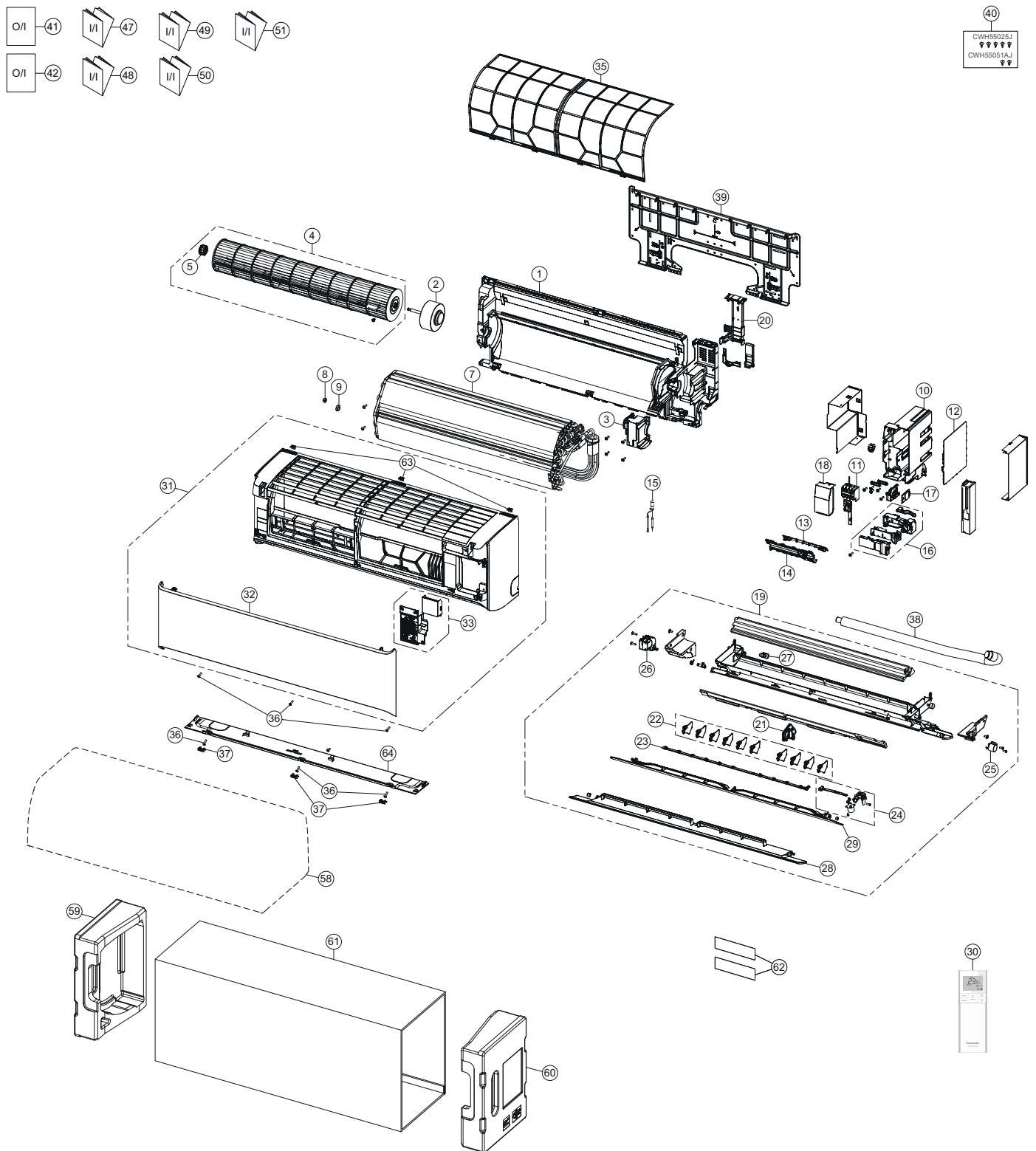

Note
 The above exploded view is for the purpose of parts disassembly and replacement.
 The non-numbered parts are not kept as standard service parts.

SAFETY	REF. NO.	PART NAME & DESCRIPTION	QTY.	CS-HZ25XKE	CS-HZ35XKE	CS-HZ25XKE-5	REMARK
	1	CHASSIS COMPLETE	1	ACXD50C04160	←	←	
⚠	2	FAN MOTOR	1	L6CBYYYYL0346	←	←	O
	3	FAN MOTOR BRACKET	1	ACXD54-04360	←	←	
	4	CROSS-FLOW FAN COMPLETE	1	ACXH02C01330	←	←	
	5	BEARING ASSY	1	CWH64K1010	←	←	
	7	EVAPORATOR	1	ACXB30C34580	←	←	
	8	FLARE NUT (LIQUID)	1	CWT251048	←	←	
	9	FLARE NUT (GAS)	1	CWT251049	←	←	
	10	CONTROL BOARD CASING	1	ACXH10-08620	←	←	
⚠	11	TERMINAL BOARD COMPLETE	1	ACXA28C06560	←	←	O
⚠	12	ELECTRONIC CONTROLLER - MAIN	1	ACXA73C76050	ACXA73C76060	ACXA73C76050	O
⚠	13	ELECTRONIC CONTROLLER-INDICATOR	1	ACXA73-40520	←	←	O
	14	INDICATOR HOLDER	1	ACXD93-22430	←	←	
⚠	15	SENSOR COMPLETE	1	CWA50C2122	←	←	O
⚠	16	GENERATOR COMPLETE	1	ACXH94C01420	←	←	O
⚠	17	ELECTRONIC CONTROLLER-WIFI	1	ACXA73-28520	←	←	O
	18	CONTROL BOARD TOP COVER	1	ACXH13-08680	←	←	
	19	DISCHARGE GRILLE COMPLETE	1	ACXE20C06080	←	←	
	20	BACK COVER CHASSIS	1	ACXD93-22420	←	←	
	21	FULCRUM	1	ACXH62-00790	←	←	
	22	VERTICAL VANE	10	ACXE24-04000	←	←	
	23	CONNECTING BAR	1	ACXE26-02550	←	←	
⚠	24	AIR SWING MOTOR ASSY	1	ACXA98K00220	←	←	O
⚠	25	AIR SWING MOTOR	1	ACXA98-02420	←	←	O
⚠	26	GEAR-COMPLETE	1	ACXH68C00520	←	←	O
	27	CAP - DRAIN TRAY	1	CWH521096	←	←	
	28	HORIZONTAL VANE COMPLETE - BIG	1	ACXE24C04660	←	←	
	29	HORIZONTAL VANE COMPLETE	1	ACXE24C04670	←	←	
⚠	30	REMOTE CONTROL COMPLETE	1	ACXA75C21260	←	←	O
	31	FRONT GRILLE COMPLETE	1	ACXE10C14210	←	←	
	32	INTAKE GRILLE COMPLETE	1	ACXE22K09860	←	←	
	33	GRILLE DOOR COMPLETE	1	ACXE14C01440	←	←	
	35	AIR FILTER	2	ACXD00-02990	←	←	
	36	SCREW - FRONT GRILLE	6	XTT4+16CFJ	←	←	
	37	CAP - FRONT GRILLE	3	ACXH52-04000	←	←	
	38	DRAIN HOSE	1	ACXH85-00210	←	←	
	39	INSTALLATION PLATE	1	ACXH36-00840	←	←	
	40	BAG COMPLETE - INSTALLATION SCREW	1	CWH82C1705	←	←	
	41	OPERATING INSTRUCTION	1	ACXF55-31270	←	←	
	42	OPERATING INSTRUCTION	1	ACXF55-28412	←	←	
	47	INSTALLATION INSTRUCTION	1	ACXF60-44200	←	←	
	48	INSTALLATION INSTRUCTION	1	ACXF60-44210	←	←	
	49	INSTALLATION INSTRUCTION	1	ACXF60-44220	←	←	
	50	INSTALLATION INSTRUCTION	1	ACXF60-44230	←	←	
	51	INSTALLATION INSTRUCTION	1	ACXF60-44240	←	←	
	58	BAG	1	CWG861497	←	←	
	59	SHOCK ABSORBER- LEFT	1	ACXG70-12960	←	←	

SAFETY	REF. NO.	PART NAME & DESCRIPTION	QTY.	CS-HZ25XKE	CS-HZ35XKE	CS-HZ25XKE-5	REMARK
	60	SHOCK ABSORBER - RIGHT	1	ACXG70-12970	←	←	
	61	C.C.CASE	1	ACXG50-58840	←	←	
	62	MODEL LABEL	2	ACXF85-74510	ACXF85-74520	ACXF85-74530	
	63	PARTICULAR PIECE - LOCK	3	ACXD93-18690	←	←	
	64	PARTICULAR PLATE	1	ACXD90-26390	←	←	

(NOTE)

- All parts are supplied from PAPAMY, Malaysia (Vendor Code: 00029488).
- "O" marked parts are recommended to be kept in stock.

21.2 Outdoor Unit

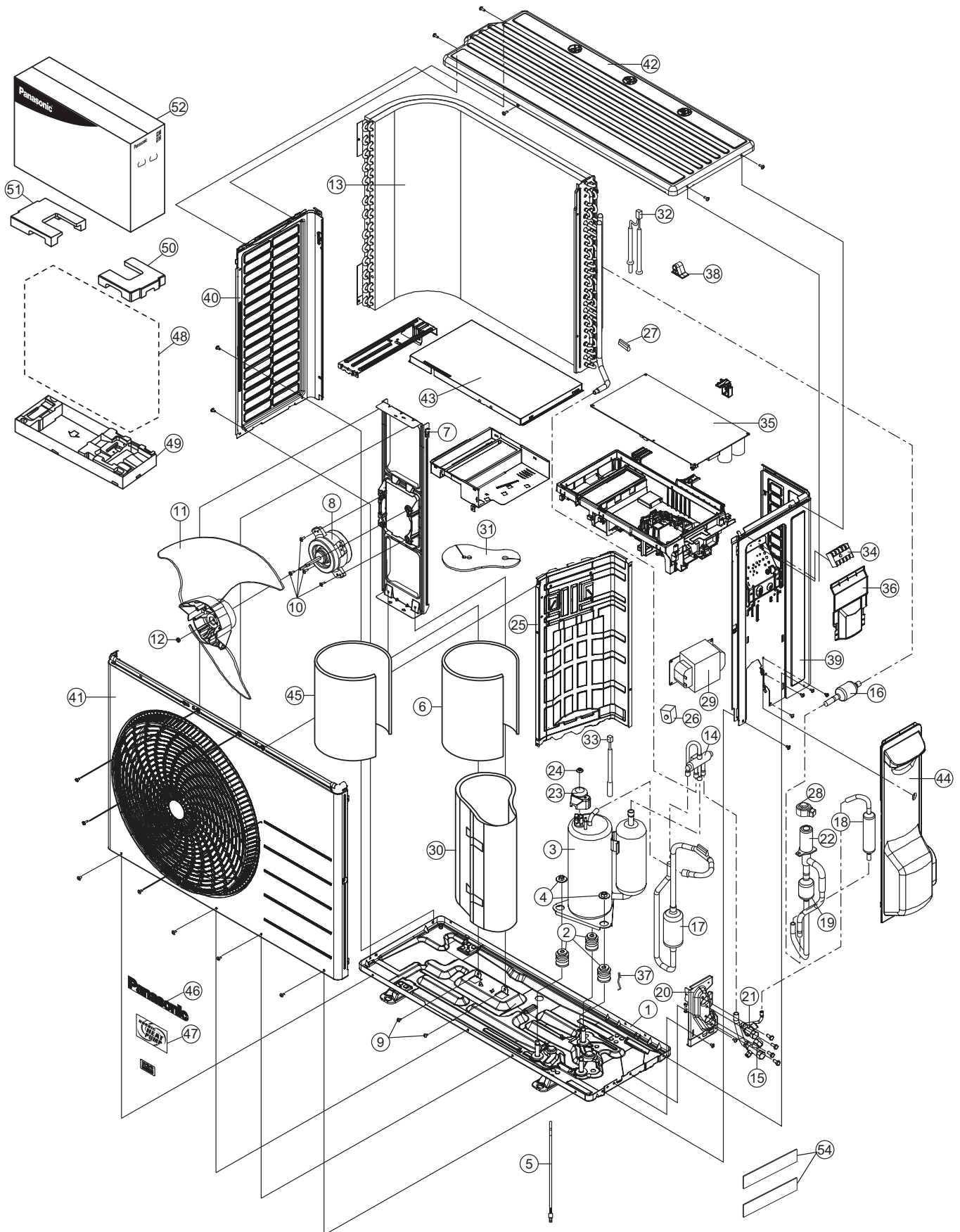

Note
The above exploded view is for the purpose of parts disassembly and replacement.
The non-numbered parts are not kept as standard service parts.

SAFETY	REF. NO.	PART NAME & DESCRIPTION	QTY.	CU-HZ25XKE	CU-HZ35XKE	CU-HZ25XKE-5	REMARK
	1	CHASSIS ASS'Y	1	CWD52K1359	←	←	
	2	ANTI - VIBRATION BUSHING	3	CWH50077	←	←	
⚠	3	COMPRESSOR	1	9RD132XGB21	←	←	O
	4	NUT - COMPRESSOR MOUNT	3	CWH561096	←	←	
	5	BASE PAN HEATER	1	CWA341072	←	←	
	6	SOUND PROOF MATERIAL	1	ACXG30-11430	←	←	
	7	BRACKET FAN MOTOR	1	CWD541167	←	←	
⚠	8	FAN MOTOR	1	L6CAYYYL0127	←	←	O
	9	SCREW - FAN MOTOR BRACKET	2	ACXH55-07140	←	←	
	10	SCREW - FAN MOTOR MOUNT	4	CWH55252J	←	←	
	11	PROPELLER FAN ASSY	1	CWH03K1066	←	←	
	12	NUT - PROPELLER FAN	1	CWH56053J	←	←	
	13	CONDENSER COMPLETE	1	ACXB32C13790	←	ACXB32C18860	
	14	4-WAYS VALVE	1	ACXB00-01290	←	←	O
	15	3-WAYS VALVE	1	ACXB01-04550	←	←	O
	16	STRAINER	1	CWB11094	←	←	
	17	DISCHARGE MUFFLER	1	ACXB12-00650	←	←	
	18	DISCHARGE MUFFLER	1	CWB121021	←	←	
	19	STRAINER	1	ACXB11-01560	←	←	
	20	HOLDER - COUPLING	1	CWH351233	←	←	
	21	2-WAYS VALVE	1	ACXB02-03370	←	←	
⚠	22	EXPANSION VALVE	1	ACXB05-00400	←	←	O
	23	TERMINAL COVER	1	CWH171039A	←	←	
	24	NUT - TERMINAL COVER	1	CWH7080300J	←	←	
	25	SOUND - PROOF BOARD	1	CWH151273	←	←	
⚠	26	V-COIL CO. (FOR 4 WAY VALVE)	1	ACXA43C00250	←	←	O
	27	HOLDER-SENSOR	1	CWH32075	←	←	
⚠	28	V-COIL CO. (FOR EXP VALVE)	1	ACXA43C01520	←	←	O
⚠	29	REACTOR	1	G0C392J00039	←	←	O
	30	SOUND PROOF MATERIAL (COMP.BODY)	1	ACXG30-11950	←	←	
	31	SOUND PROOF MATERIAL (COMP. TOP)	1	CWG302656	←	←	
⚠	32	SENSOR - CO. (AIR & PIPE TEMP)	1	CWA50C3079	←	←	O
⚠	33	SENSOR - CO. (COMP TEMP)	1	ACXA50C17390	←	←	O
⚠	34	TERMINAL BOARD ASS'Y	1	CWA28K1110J	←	←	O
⚠	35	ELECTRONIC CONTROLLER - MAIN	1	ACXA73C77810R	ACXA73C77820R	ACXA73C77810R	O
	36	PLATE - C. B. COVER	1	CWH131470	←	←	
	37	HOLDER - SENSOR	1	CWH32143	←	←	
	38	HOLDER - SENSOR	1	CWH321113	←	←	
	39	CABINET SIDE PLATE CO.	1	ACXE04C05240	←	←	
	40	CABINET SIDE PLATE (L)	1	ACXE04-10020	←	←	
	41	CABINET FRONT PLATE - CO.	1	ACXE06C02890	←	←	

SAFETY	REF. NO.	PART NAME & DESCRIPTION	QTY.	CU-HZ25XKE	CU-HZ35XKE	CU-HZ25XKE-5	REMARK
	42	CABINET TOP PLATE	1	ACXE03-02880	←	←	
	43	CONTROL BOARD COVER	1	CWH131473	←	←	
	44	CONTROL BOARD COVER - COMPLETE	1	ACXH13C02860	←	←	
	45	SOUND PROOF MATERIAL	1	CWG302745	←	←	
	46	PANASONIC BADGE	1	CWE373439	←	←	
	47	NORDIC HEATPUMP LABEL	1	CWE373985	←	←	
	48	BAG	1	ACXG86-03760	←	←	
	49	BASE BOARD - COMPLETE	1	CWG62C1162	←	←	
	50	SHOCK ABSORBER (R)	1	CWG713415	←	←	
	51	SHOCK ABSORBER (L)	1	CWG713416	←	←	
	52	C. C. CASE	1	ACXG50-48900	←	←	
	54	MODEL LABEL	2	ACXF85-69250	ACXF85-69260	ACXF85-69270	

(Note)

- All parts are supplied from PAPAMY, Malaysia (Vendor Code: 00029488).
- "O" marked parts are recommended to be kept in stock.