

BÖJ

BDEB 45° - PRESSAD

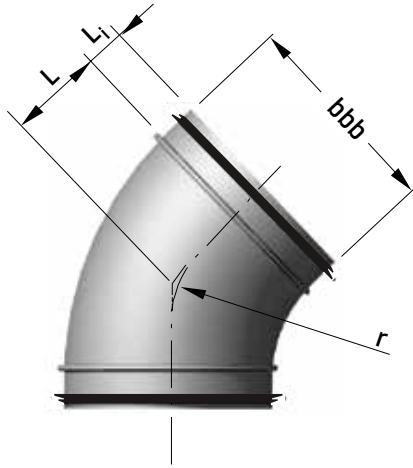

BDEB 45° - SEGMENTBYGGD

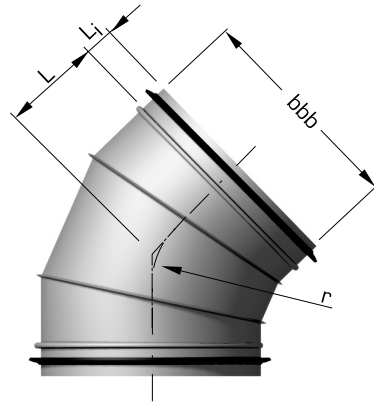

STORLEKAR

BDEB-45-bbb	L (mm)	r (mm)	Li (mm)	Vikt (kg)
-006	50	100	35	0.16
-008	40	100	35	0.23
-010	40	100	35	0.25
-012	50	125	35	0.38
-016	65	160	35	0.54
-020	80	200	35	0.80
-025	105	250	35	1.00

STORLEKAR

BDEB-45-bbb	L (mm)	r (mm)	Li (mm)	Vikt (kg)
-031	130	315	35	1.80
-040	165	400	60	3.40
-050	205	500	60	4.60
-063	260	630	60	6.90
-080	330	800	95	12.0
-100	410	1000	95	23.0
-125	515	1250	95	34.0