

The Halton FDI fire damper is installed on walls or ceilings between fire compartments penetrated by the air inlet.

The fire resistance class is EI 60 (v, h_o) S when the damper is installed through masonry walls and plates, or lightweight panel walls. In installation through masonry plates, it is E 90 (h_o)S.

1

The maximum size of the installation opening in masonry structures is the duct diameter + 20 mm.

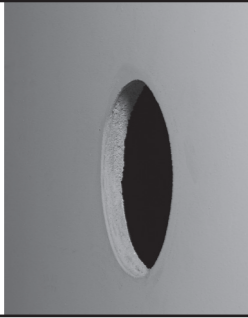

2

When installing the fire damper on lightweight panel walls, cut a round installation hole that is as close to the size of the duct as possible. The opening must not be larger than the duct diameter + 20 mm. A steel frame or a wooden joist must be mounted on the edges of the opening.



3

The wall shall be built so as to achieve the required non-combustibility.



4

Fill the corners with a mineral wool that corresponds to the insulation of the wall, min. 40 kg/m³. The wool must reach the product along its entire perimeter.

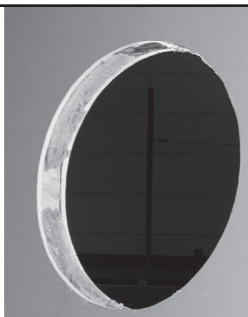

5

For thick structures, the duct joint must be made before the product is placed on the opening in the structural element.



6

The fire damper is centred in the installation hole. Via the installation flange, attach the damper to a steel frame or wooden joist with screws, or to a masonry structure with 8 mm steel wedge anchors. The blade shaft position is not limited, and orientation may be horizontal or vertical. Verify that the product operates correctly before applying fire prevention mastic.



7

For wall installations, the fuse for sizes Ø 400, 500, and 630 must be positioned at the centre line of the duct or directly above. If the manual actuator is installed below the centre line, the fuse must be moved to the opposite side of the manual actuator. The fuse is removed from beside the handle.



8

The screw is removed from the location for the spare fuse and is replaced with the fuse.



9

Insert the screw in the place of the original fuse.



10

To set the manually operated model, loosen the fuse (turn anti-clockwise).



11

The shut-off blade is set in the open position and the fuse tightened (clockwise direction). If the shut-off blade does not remain open, the fuse must be replaced.



12

During grouting, the actuator and fire damper must be covered. To achieve non-combustibility, the casing is filled to the edges with a type-approved fire prevention mastic, such as GBG (from Palokatkomiehet Oy), CP 637 (Hilti) or Sealfire W1000 (Würth).



13

The fuse is installed either on the same side as the actuator or on the opposite side of the wall. Drill an approximately 10-mm hole in the duct, and fasten the fuse inside the duct with screws. Noting the space required by the turning blade.



14

When the power is off, the electric actuator can be tested manually by means of a hexagonal spanner (included in the delivery).

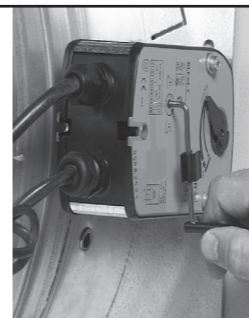

15

The electric actuator can be tested when the power is on, by means of the fuse switch.



CE

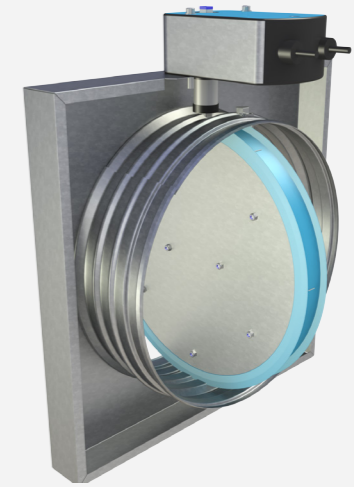

© Halton

FIRE DAMPER HALTON FDI

INSTALLATION INSTRUCTIONS AND PROOF OF INSTALLATION

01.01.2017

www.halton.com

Enabling Wellbeing

Halton

Example of installation on a lightweight plasterboard wall

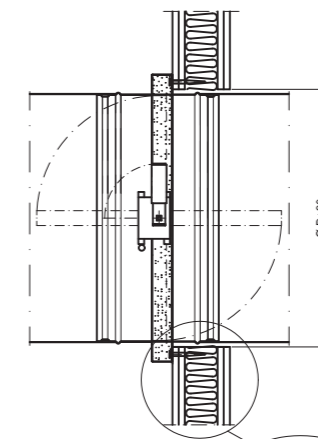

Example of installation on a concrete and masonry element

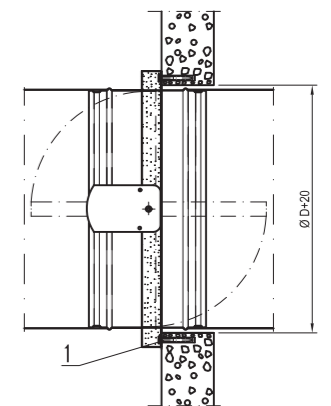

1. Metal wedge anchor (e.g., M8 x 50)

1. Frame
2. Mineral wool, min. 40 kg/m³
3. Gypsum boards
4. Mounting screw (e.g., 6.5 x 50)

Connection via a safety isolating transformer

Wiring diagram

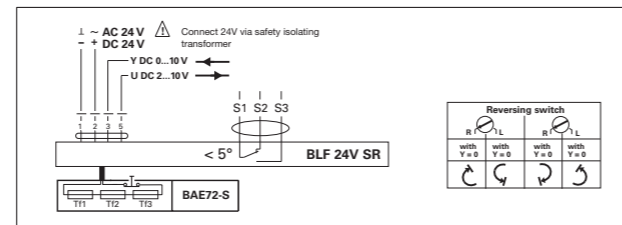
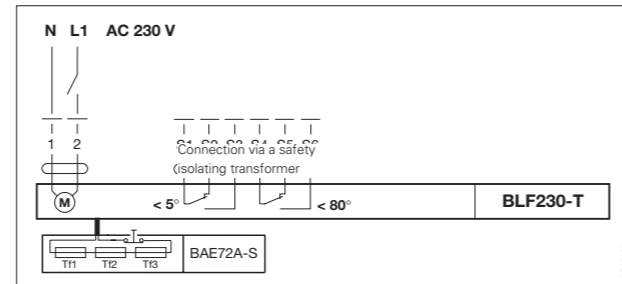
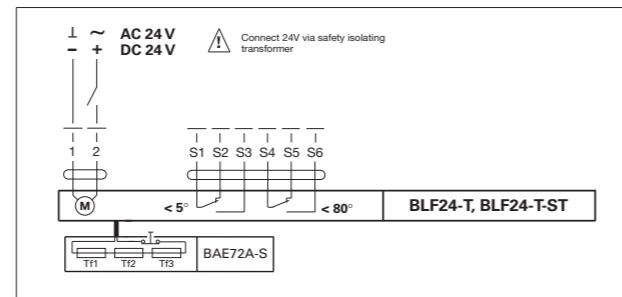

Wiring diagram for a manual model (limit switch)

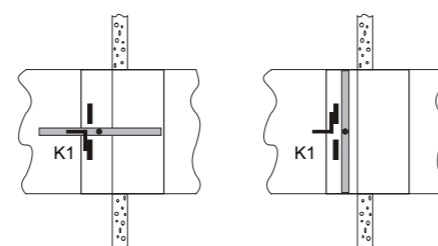

Open	Closed
K1:	K1:
13/14 closed	13/14 open
21/22 open	21/22 closed

This Proof of Installation form applies only to Halton products.
The form must be filled in for each fire and smoke control damper when it is installed.

Halton FDI is CE marked by Construction Product Regulation,
Certificate of Constancy of Performance 0809-CPR-1158

Name of the installation location: _____

Address: _____

Individual product number from the type plate (production order no.): _____

Performance rating of the fire damper fuse: _____

Contractor contact details:

Company name: _____

Address: _____

Company telephone no.: _____

E-mail or Web address: _____

Installer's telephone no.: _____

Installer name(s): _____

Date of installation: _____

Installation location identification (section/floor/room): _____

Notes and considerations: _____

I hereby verify that the installation of this fire damper, the tightness of the gland,
and the testing of the product have been performed according to the manufacturer's
installation instructions:

Place and date: _____, on _____ / _____, 20_____

Installer's name and signature: _____

Installation supervisor's name and signature: _____

This Proof of Installation must be enclosed with the deed of transfer of the building in question,
and a copy of it must be given to rescue officials upon request.