



ETA-Danmark A/S
Göteborg Plads 1
DK-2150 Nordhavn
Tel. +45 72 24 59 00
Internet www.etadanmark.dk

Authorised and notified
according to Article 29 of the
Regulation (EU)
No 305/2011 of the European
Parliament and of the Council
of 9 March 2011



European Technical Assessment ETA-21/0842 of 2021/10/18

I General Part

Technical Assessment Body issuing the ETA and designated according to Article 29 of the Regulation (EU) No 305/2011: ETA-Danmark A/S

Trade name of the construction product:

GRAFT IPT Multi Sealant & Adhesive

Product family to which the above construction product belongs:

Fire Stopping and Sealing Product:

- Linear Joint and Gap Seals

Manufacturer:

Polyseam Ltd
15. St. Andrews Road
Huddersfield, West Yorkshire
HD1 6SB, UK

Manufacturing plant:

Polyseam Ltd
15. St. Andrews Road
Huddersfield, West Yorkshire
HD1 6SB, UK

This European Technical Assessment contains:

12 pages including 1 annex which form an integral part of the document

This European Technical Assessment is issued in accordance with Regulation (EU) No 305/2011, on the basis of:

EAD 350141-00-1106

This version replaces:

-

Translations of this European Technical Assessment in other languages shall fully correspond to the original issued document and should be identified as such.

Communication of this European Technical Assessment, including transmission by electronic means, shall be in full. However, partial reproduction may be made, with the written consent of the issuing Technical Assessment Body. Any partial reproduction has to be identified as such.

Table of Contents

I.	SPECIFIC PARTS OF THE EUROPEAN TECHNICAL ASSESSMENT	4
1	Technical description of the product	4
2	Specification of the intended uses of the product in accordance with the applicable European Assessment Document (Hereinafter EAD): EAD 350141-00-1106, September 2017	5
3	Performance of the product and references to the methods used for its assessment	6
4	ASSESSMENT AND VERIFICATION OF CONSTANCY OF PERFORMANCE (HEREINAFTER AVCP) SYSTEM APPLIED, WITH REFERENCE TO ITS LEGAL BASE.....	7
5	Technical details necessary for the implementation of the AVCP system, as provided for in the applicable EAD	7
	ANNEX A – Resistance to Fire Classification – GRAFT IPT Multi Sealant & Adhesive	8
A.1	Flexible and rigid wall constructions according to 1.2.1 with wall thickness of minimum 75 mm	8
A.1.1	Linear joint seals, between head of flexible wall min. 75 mm thick and soffit of concrete floor	8
A.2	Flexible and rigid wall constructions according to 1.2.1 with wall thickness of minimum 100 mm	9
A.2.1	Linear joint seals, between head of flexible wall min. 100 mm thick and soffit of concrete floor	9
A.2.2	100
A.3	Rigid wall constructions according to 1.2.1 with wall thickness of minimum 150 mm	111
A.3.1	Linear joint or gap seal, between head of rigid wall and soffit of concrete floor / between rigid walls.....	111
A.4	Rigid floor constructions according to 1.2.1 with floor thickness of minimum 150 mm.....	122
A.4.1	Linear joint or gap seal, between concrete floors and between the end of concrete floors and rigid walls	122

I. SPECIFIC PARTS OF THE EUROPEAN TECHNICAL ASSESSMENT

1 Technical description of the product

- 1) GRAFT IPT Multi Sealant & Adhesive is a sealant used to form linear gap seals where gaps are present in wall and floor constructions and linear joint seals where wall and floor constructions abut.
- 2) The GRAFT IPT Multi Sealant & Adhesive is supplied in liquid form contained within 200 ml, 300 ml, 380 ml and 600 ml containers. The sealant is gunned into the aperture in the separating element/elements and around the service or services, to a specified depth.
- 3) GRAFT IPT Multi Sealant & Adhesive contains no carcinogenic substances or mutagenic substances, flame retardants or antimicrobiological agents.
- 4) Polyseam AS submitted a written declaration that the product and/or constituents of the product contains no substances which have been classified as dangerous according to Directive 67/548/EEC and Regulation (EC) No. 1272/2008 and listed in the 'indicative list on dangerous substances' of the EGDS – taking into account the installation conditions of the construction product and the release scenarios resulting from there.

In addition to the specific clauses relating to dangerous substances contained in this European Technical Assessment, there may be other requirements applicable to the products falling within its scope (e.g. transposed European legislation and national laws, regulations and administrative provisions). In order to meet the provisions of the Construction Products Regulation, these requirements need also to be complied with, when and where they apply.

- 5) The use category of GRAFT IPT Multi Sealant & Adhesive in relation BWR 4 (safety in use) is IA1, S/W3

2 Specification of the intended uses of the product in accordance with the applicable European Assessment Document (Hereinafter EAD): EAD 350141-00-1106, September 2017

Detailed information and data is given in Annex A.

The intended use of system GRAFT IPT Multi Sealant & Adhesive is to reinstate the fire resistance performance of gaps in and joints in and between flexible wall and rigid wall constructions, gaps in and joints between rigid floor constructions.

- 1) The specific elements of construction that the system GRAFT IPT Multi Sealant & Adhesive may be used to provide a gap or joint seal in, are as follows:

Flexible walls: The wall must have a minimum thickness of 75 mm and comprise steel studs or timber studs* lined on both faces with minimum 1 layer of 12.5 mm thick boards. The wall is permitted with or without insulation.

Rigid walls: The wall must have a minimum thickness of 75 mm and comprise concrete, aerated concrete or masonry, with a minimum density of 650 kg/m³.

Rigid floors: The floor must have a minimum thickness of 150 mm and comprise aerated concrete or concrete with a minimum density of 650 kg/m³.

* no part of the penetration seal may be closer than 100 mm to a stud, the cavity must be closed between the penetration seal and the stud, and minimum 100 mm of insulation of class A1 or A2 according to EN 13501-1 must be provided within the cavity between the penetration seal and the stud.

The supporting construction must be classified in accordance with EN 13501-2 for the required fire resistance period.

- 2) The system GRAFT IPT Multi Sealant & Adhesive may be used to provide a linear joint or gap seal with specific supporting constructions and substrates (for details see Annex A).
- 3) The maximum permitted joint/gap width for system GRAFT IPT Multi Sealant & Adhesive is 30 mm.
- 4) The maximum movement capability of system GRAFT IPT Multi Sealant & Adhesive when used as a linear joint or gap seal within the scope of this ETA is $\leq 7.5\%$
- 5) The provisions made in this European Technical Assessment are based on an assumed working life of the GRAFT IPT Multi Sealant & Adhesive of 25 years, provided that the conditions laid down in the manufacturers' instructions and datasheet for the packaging/transport/storage/installation/use/ repair are met. The indications given on the working life cannot be interpreted as a guarantee given by the producer or the Technical Assessment Body but are to be regarded only as a means for choosing the right products in relation to the expected economically reasonable working life of the works.
- 6) Type X: intended for use at conditions exposed to weathering and all lower classes.

3 Performance of the product and references to the methods used for its assessment

Product-type: Sealant	Intended use: Linear Joint & Gap Seal
Essential characteristic	Product Performance
BWR 2 Safety in case of fire	
Reaction to fire	Class D-s2, d0
Resistance to fire	Annex A
BWR 3 Hygiene, health and environment	
Content, emission and/or release of dangerous substances	Declaration of manufacturer
Air permeability (material property)	No performance assessed
Water permeability (material property)	No performance assessed
BWR 4 Safety in use	
Mechanical resistance and stability	No performance assessed
Resistance to impact/movement	No performance assessed
Adhesion	No performance assessed
Durability	X
Movement capacity	No performance assessed
Cycling of perimeter seals for curtain walls	No performance assessed
Compression set	No performance assessed
Linear expansion on setting	No performance assessed
BWR 5 Protection against noise	
Airborne sound insulation	Rw (C;Ctr)= 62 (0;-4) dB*
BWR 6 Energy economy and heat retention	
Thermal properties	No performance assessed
Water vapour permeability	No performance assessed

* At minimum 12 mm depth

4 ASSESSMENT AND VERIFICATION OF CONSTANCY OF PERFORMANCE (HEREINAFTER AVCP) SYSTEM APPLIED, WITH REFERENCE TO ITS LEGAL BASE

According to the decision 1999/454/EC – Commission Decision of date 22nd June 1999 on the procedure for attesting the conformity of construction products pursuant to Article 20(2) of Council Directive 89/106/EEC as regards fire stopping, fire sealing and fire protective products, published in the Official Journal of the European Union (OJEU) L178/52 of 14/07/1999, see <http://eur-lex.europa.eu/JOIndex.do> of the European Commission¹, as amended, the system(s) of assessment and verification of constancy of performance (see Annex V to Regulation (EU) No 305/2011) given in the following table(s) applies (apply).

Product(s)	Intended use(s)	Level(s) or class(es)	System(s)
Fire stopping and Fire Sealing Products	For fire compartmentation and/or fire protection or fire performance	Any	1

5 Technical details necessary for the implementation of the AVCP system, as provided for in the applicable EAD

Technical details necessary for the implementation of the AVCP system are laid down in the control plan deposited at ETA-Danmark A/S prior to CE marking

Issued in Copenhagen on 2021-10-18 by



Thomas Bruun

Managing Director, ETA-Danmark

¹ Official Journal of the European Communities L178/52 of 14/7/1999

ANNEX A – Resistance to Fire Classification – GRAFT IPT Multi Sealant & Adhesive

A.1 Flexible and rigid wall constructions according to 1.2.1 with wall thickness of minimum 75 mm

A.1.1 Linear joint seals, between head of wall min. 75 mm thick and soffit of concrete floor

Joint Seal: GRAFT IPT Multi Sealant & Adhesive to both sides of the wall, joint widths up to 25 mm

Construction details:

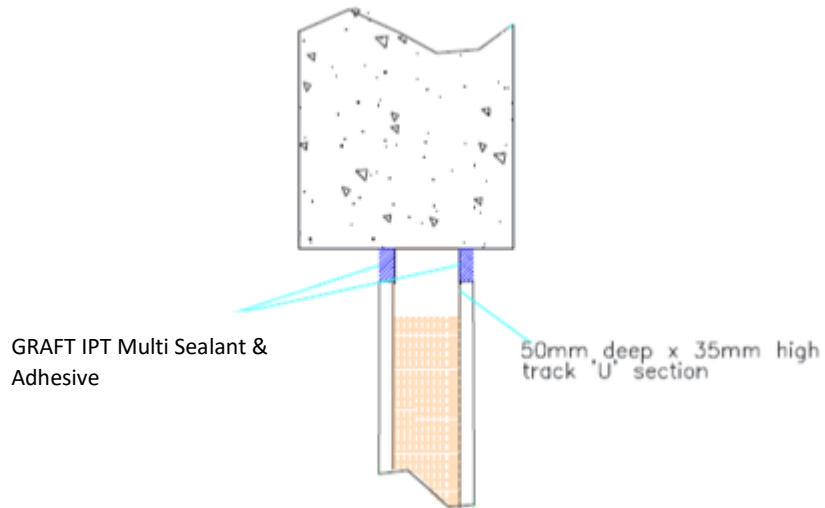

A.1.1.1

Substrate	Depth (mm)	Backing	Classification
Wall/Floor	12.5 min.	Minimum 50 mm steel partition head track/stud	E 60 – T – X – F – W 25 EI 45 – T – X – F – W 25

A.2 Flexible and rigid wall constructions according to 1.2.1 with wall thickness of minimum 100 mm

A.2.1 Linear joint seals, between head or side of wall min. 100 mm thick and soffit of concrete floor

Joint Seal: GRAFT IPT Multi Sealant & Adhesive to both sides of the wall, joint widths up to 30 mm

Construction details:

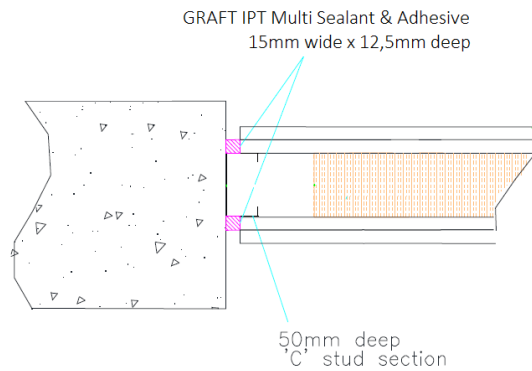
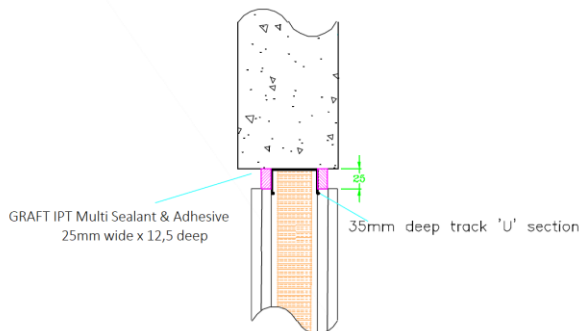
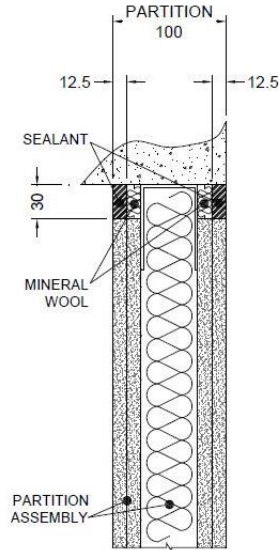

A.2.1.1

Substrate	Depth (mm)	Backing	Classification
Wall/Floor	12.5 min.	12.5 mm stonewool minimum 35 kg/m ³ plus minimum 50 mm steel partition head track	EI 120 – T – X – F – W 30
		Minimum 50 mm steel partition head track /stud	E 90 – T – X – F – W 25
			EI 60 – T – X – F – W 25
			EI 120 – V – X – F – W 15

A.2.2

Joint Seal: GRAFT IPT Multi Sealant & Adhesive to both sides of the wall, joint widths up to 30 mm

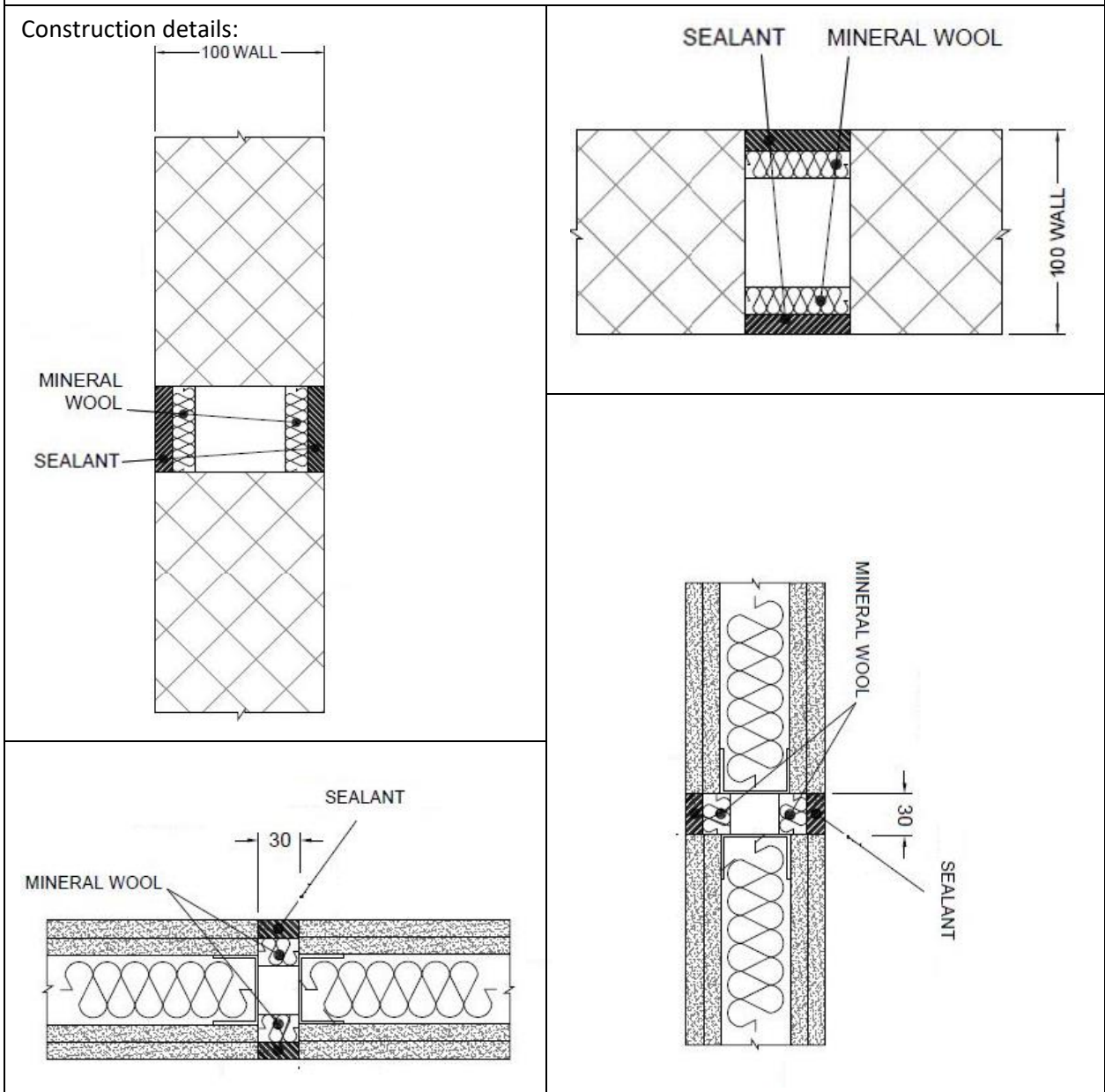

A.2.2.1

Substrate	Depth (mm)	Backing	Classification
Wall/Floor	12.5 min.	12.5 mm stonewool minimum 35 kg/m ³	EI 120 – T – X – F – W 30 EI 120 – V – X – F – W 30

A.3 Rigid wall constructions according to 1.2.1 with wall thickness of minimum 150 mm

A.3.1 Linear joint or gap seal, between head of rigid wall and soffit of concrete floor / between rigid walls

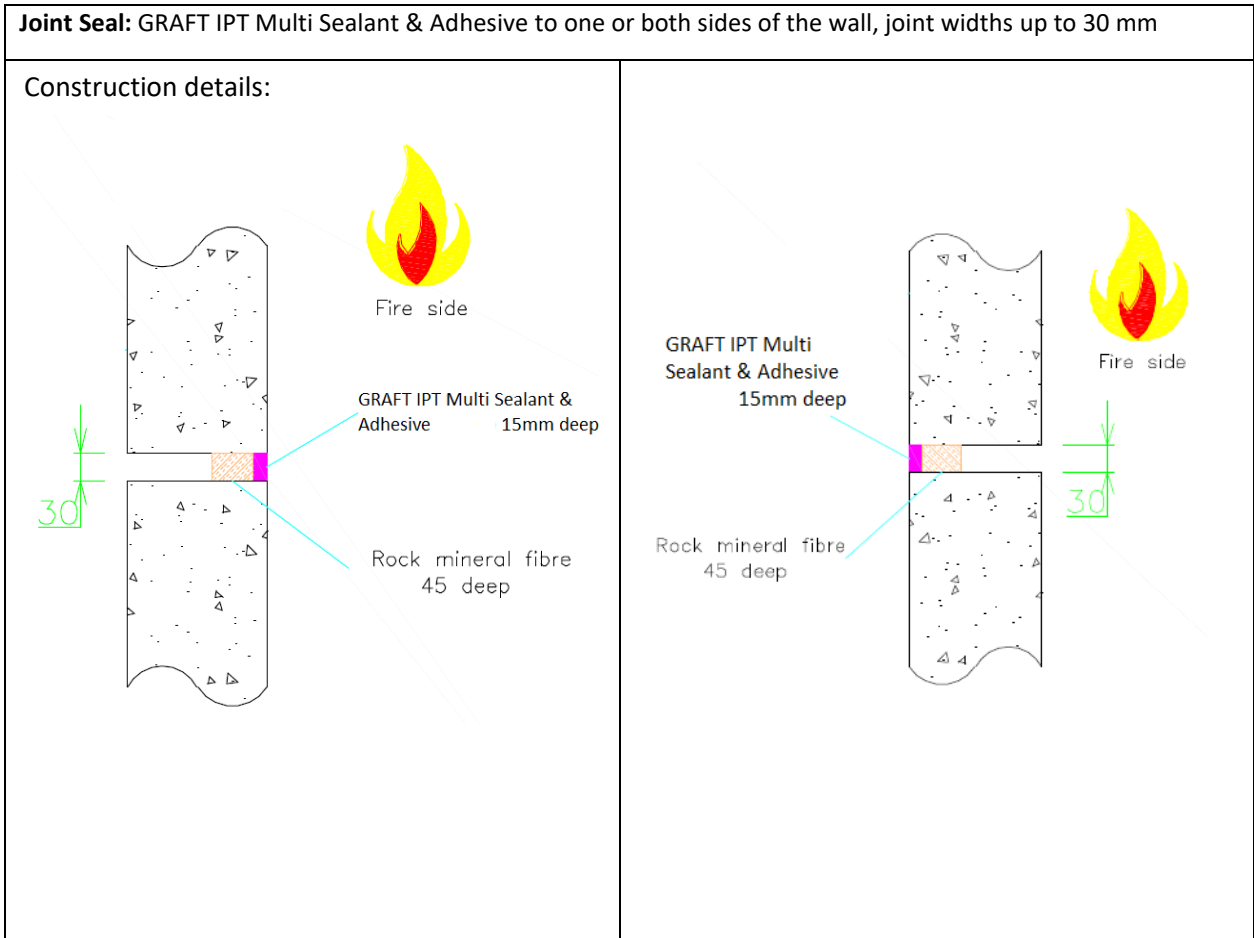

A.3.1.1

Substrate	Depth (mm)	Backing	Classification
Concrete/ masonry	15 min. (one side)	45 mm stone wool minimum 33 kg/m ³	E 240 – T – X – F – W 30 EI 60 – T – X – F – W 30
	15 min. (both side)	45 mm stone wool minimum 33 kg/m ³	EI 240 – T – X – F – W 30

A.4 Rigid floor constructions according to 1.2.1 with floor thickness of minimum 150 mm

A.4.1 Linear joint or gap seal, between concrete floors and between the end of concrete floors and rigid walls

Joint Seal: GRAFT IPT Multi Sealant & Adhesive to one or both sides of the floor, joint widths up to 30 mm

Construction details:

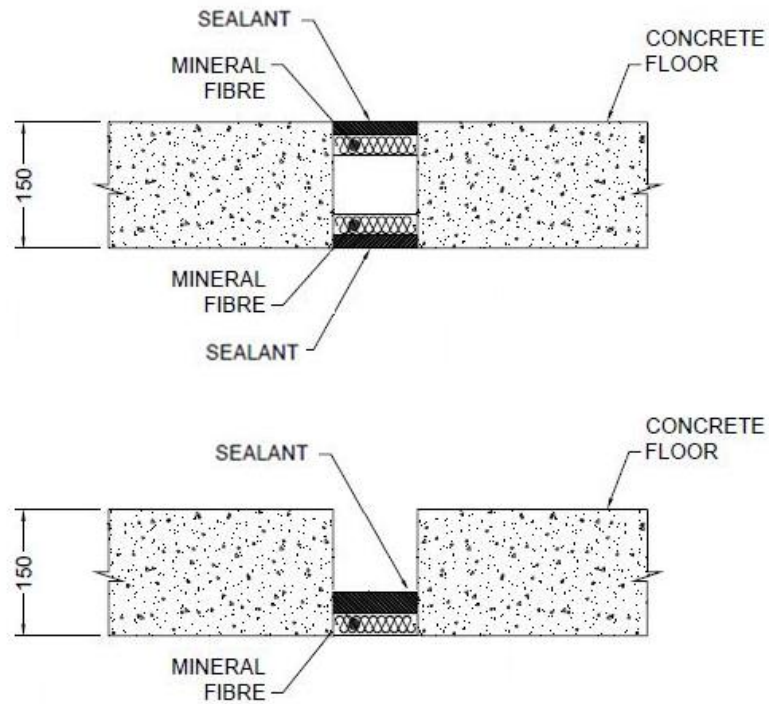

A.4.1.1

Substrate	Depth (mm)	Backing	Classification
Concrete	15 min. to both faces	20 mm stonewool minimum 33 kg/m ³	EI 240 – H – X – F – W 30
	25 mm	48 mm Mineral Fibre BIO 128 kg/m ³	E 240 – H – X – F – W 30 EI 180 – H – X – F – W 30